



2022 Product Catalog

Residential Stormwater Management
Commercial Stormwater Management
Professional Irrigation
Flow Management



50 
SINCE 1972

**YEARS AS YOUR KNOWLEDGEABLE
AND TRUSTED PARTNER IN WATER
MANAGEMENT SOLUTIONS.**

MADE IN
USA



Since 1972, NDS has been producing plastic drainage and landscape products. From the beginning, our commitment to leading the industry has been unwavering, leading to remarkable innovations and state-of-the-art products that fit every environment, every schedule, every need.

Today, our commitment to providing one-source solutions has led to the development of superior quality drainage products, landscape products, fittings, valve and meter boxes, and drip and micro irrigation products. No product is added to our line without meeting exhaustive testing and extensive research requirements. Plus, NDS is uniquely able to offer our complete inventory of products from regional warehouses in the US and Puerto Rico. Our goal: one-business-day delivery. Our track record: outstanding.

Take a moment to look through this catalog, noting the depth of our product offering. If you have any questions or to place an order, just call 1-800-726-1994 from 5 a.m. to 5 p.m. PST and let us offer the best solution to you.

THE NDS BRAND PROMISE

NDS is your knowledgeable and trusted partner for the best in water management solutions.

Our products are engineered and produced for performance, durability, ease of installation and the efficient use of resources.

We provide the service and support to ensure that you are successful.

TABLE OF CONTENTS

18	Drainage
52	Channel & Trench Drains
90	Permeable Pavers
96	Landscape
102	Professional Irrigation
142	Flow Management
168	Fittings & Clamps
190	Access Boxes





NDS products have been a reliable and trusted choice for use on over 500 projects. Never a problem, never a failure.

David Silver

AAA Landscape Specialists, Inc.

President and CEO

We put water in its place



RESIDENTIAL SOLUTIONS

Water Management at Any Scale

Water on Patio/Pool Deck

Channel Drains prevent water pooling on patio or pool deck, potentially causing moss or mildew growth, concrete staining, and dangerous slip hazards. (pp. 52-87)

Flow Management

Ball Valves and Check Valves are integral components of aquatic pump and filter assemblies. (pp. 148-156)

Downspout Runoff

Catch Basin and Grates remove water from downspouts and away from foundations. (pp. 26-35)

Landscape Irrigation

Drip and Micro Irrigation conserve water by delivering it efficiently to plants and turf. See *Professional Irrigation* (pp. 102-139)

Water on Driveway

Channel Drain and Grates collect sheets of water moving across driveways and sidewalks. (pp. 52-87)

Stormwater Detention & Infiltration

NDS® StormChambers® and Flo-Well® provide high-volume detention and infiltration capacity for managing stormwater runoff close to the source. (pp. 14-25)

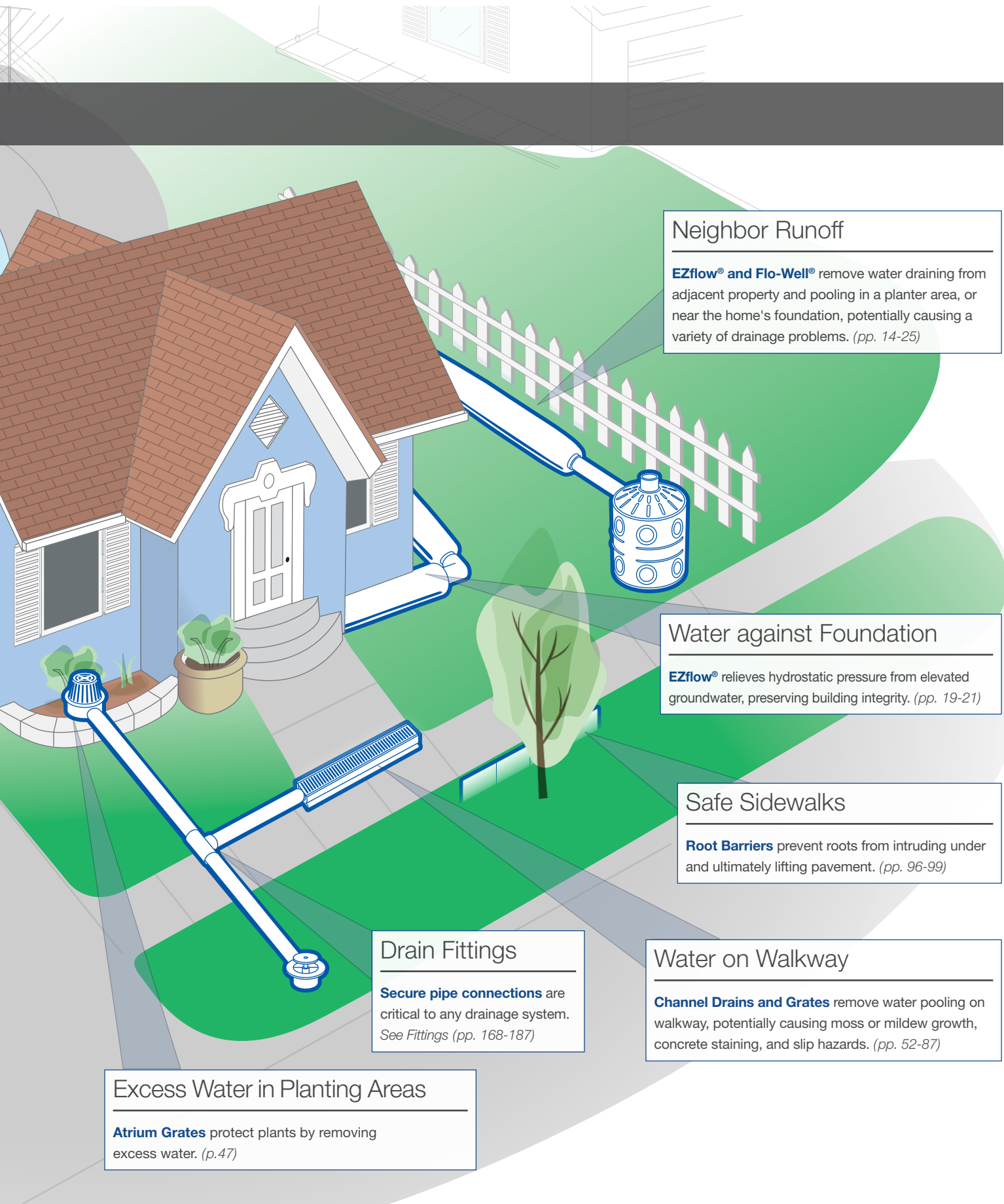

Neighbor Runoff
EZflow® and Flo-Well® remove water draining from adjacent property and pooling in a planter area, or near the home's foundation, potentially causing a variety of drainage problems. (pp. 14-25)

Water against Foundation
EZflow® relieves hydrostatic pressure from elevated groundwater, preserving building integrity. (pp. 19-21)

Safe Sidewalks
Root Barriers prevent roots from intruding under and ultimately lifting pavement. (pp. 96-99)

Drain Fittings
Secure pipe connections are critical to any drainage system. See *Fittings* (pp. 168-187)

Water on Walkway
Channel Drains and Grates remove water pooling on walkway, potentially causing moss or mildew growth, concrete staining, and slip hazards. (pp. 52-87)

Excess Water in Planting Areas
Atrium Grates protect plants by removing excess water. (p.47)

NEIGHBORHOOD SOLUTIONS

Water Management at Any Scale

Reinforced Turf & Gravel

Permeable Paver Systems used in firelanes, service vehicle access ways and overflow parking produce significantly less stormwater runoff than hard surfaces. (pp. 90-95)

Permeable Pavers

EZ Roll™ gravel patios and walkways maintain permeability and reduce runoff. (p. 94)

Stormwater Detention & Infiltration

Using **Dry Wells** and **Infiltration Trenches** is a best management practice for treating stormwater runoff close to its source. (pp. 18-25)

Stormwater Detention & Infiltration

NDS® StormChambers® offer a lower cost alternative to drainage pipes. (pp. 15, 19, 22-23)

Downspout Runoff

Catch Basins and Grates remove stormwater from downspouts and away from foundations and landscaped areas. (pp. 26-35)

Landscape Irrigation

Drip and Micro Irrigation conserve water by delivering it efficiently to plants and turf. See *Professional Irrigation* (pp. 102-139)

Parking and Service Area Runoff

Heavy-Duty Basins, Channel/Trench Drains and **Grates** handle large runoff flows and vehicular loading. (pp. 26-35 & pp. 52-87)

Flooded Planters

Poor drainage is a leading contributor to plant mortality in the urban landscape. Proper drainage such as **EZflow®** improves soil and plant health and protects adjacent infrastructure. (pp. 19-21)

Drip Irrigation

Drip and Micro Irrigation is an ideal solution to conserve water for rooftop plants and gardens. See *Professional Irrigation* (pp. 102-139)

Safe Streets & Sidewalks

Root Barriers prevent roots from intruding under and ultimately lifting pavement. (pp. 96-99)

Drain Fittings

Secure pipe connections are critical to any drainage system. See *Fittings* (pp. 168-187)

Roadway Runoff

Channel and Trench Drains receive sheet flow from roadways and complement larger stormwater management systems. (pp. 52-87)

Meter Boxes

Strength, durability and functionality are hallmarks of our line. (pp. 204-218)

COMMUNITY SOLUTIONS

Water Management at Any Scale

Large Roof Runoff

High-Capacity Subsurface Detention and Infiltration Systems including NDS® StormChambers® manage large roof runoff volumes in adjacent green areas or under parking lots. (pp. 18-25)

Athletic Field Drainage

Playability after rain events is critical in maintaining field integrity. **EZflow®** is an ideal drainage system for many field types. (pp. 19-21)

Reinforced Turf

Permeable Paver Systems used in grassed access ways produce significantly less stormwater runoff than hard surfaces. (pp. 90-95)

Subsurface Irrigation

Dura Flo™ CV Check Valve Drip Line is the efficient choice for healthy turf. (p. 108-109)

400M Track Runoff

Dura Slope™ EZ-Track™ System uses radius couplings to easily make the turn on running tracks, eliminating difficult miter cuts. (p. 77)

Landscape Irrigation

Drip and Micro Irrigation conserves water by delivering it efficiently to plants and turf. See *Professional Irrigation* (pp. 102-139)

Courtyard Runoff

Catch Basins (pp. 26-35) and **Channel Drains** (pp. 52-87) keep pedestrian areas well-drained.

Pool Deck Drainage

Channel and **Trench Drains** keep the pool deck dry and safe with many decorative and heel-proof grate options. (pp. 52-87)

Safe Pool Deck

Root Barriers preserve the integrity of adjacent paved areas by preventing root intrusion. (pp. 96-99)

Reinforced Gravel with Delineators

EZ Roll™ gravel parking areas maintain permeability and reduce runoff, while **EZ Marker™** clearly delineates parking stalls. (pp. 94-95)

Flow Management

Ball and Check Valves are integral components of aquatic pump and filter assemblies. (pp. 148-156)



DRAINAGE

From your backyard patio to the neighborhood aquatic center, from the factory floor to a professional sports facility, NDS offers the right drainage solutions.

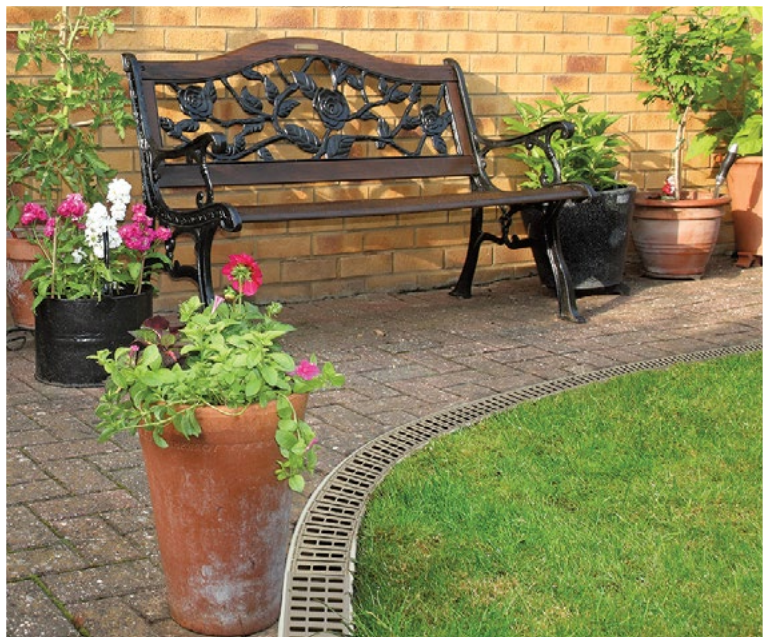
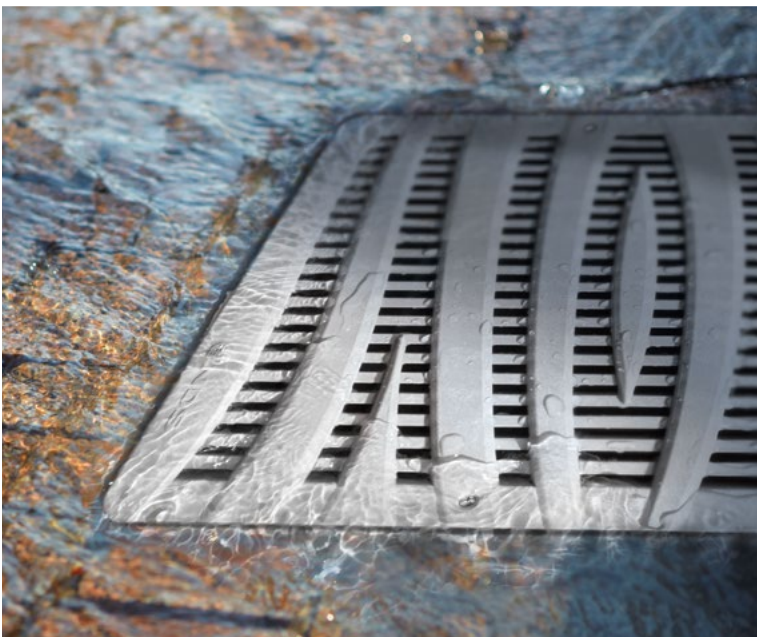





COMMERCIAL STORMWATER SOLUTIONS

NDS® offers comprehensive commercial stormwater solutions in line with Low Impact Development policies by managing stormwater as close to its source as possible through runoff reduction and quality enhancement at the site scale. Our solution is built around known and trusted components, providing solutions that offer 5 key benefits:

- Conservation of water resources to improve our well-being
- Management of stormwater at the source to reduce downstream impact
- Flexibility of system footprint allows for adaptive implementation
- Mitigation of pollution and erosion to protect water systems
- Replenishment of groundwater to help ensure future supply

A single-source solution, NDS is easy to specify, qualifies for LEED credits and offers up to 250% more detention volume than traditional gravel systems.

Design Your System

An effective onsite stormwater system can be designed in 5 easy steps:

- 1 Identify Sources** - Stormwater runoff may come from point sources like downspouts, as sheet flow from parking lots, irregularly through drainage ways in the landscape, or even as elevated groundwater.
- 2 Select Method of Capture** - Each runoff source has a practical method of capture for conveyance to the detention and infiltration area.
- 3 Determine Peak Flow and Detention Volume** - The quantity of runoff for a given rainfall event over a defined area is easily calculated when surface type and rainfall intensity are known by using the Rational Method formula $Q = CiA$. Applicable regulations generally provide guidance on the rainfall intensity to use for a given set of circumstances.
- 4 Size the System** - Detention and infiltration devices have measured holding capacities. Select the appropriate quantity and arrangement of devices to handle the predetermined runoff volume calculated above. Also consider the capacity of conveyance and overflow piping.
- 5 Determine Field Layout** - Site constraints including setbacks, landform, soil types, fixed objects and open space, among others, will inform the location and arrangement of system components. Each element of runoff capture, filtration, conveyance, detention, infiltration and overflow must be considered.

CAPTURE

Catch basins receive runoff from downspouts and landscaped areas. **Channel drains** accept sheet flows from paved walks and parking.

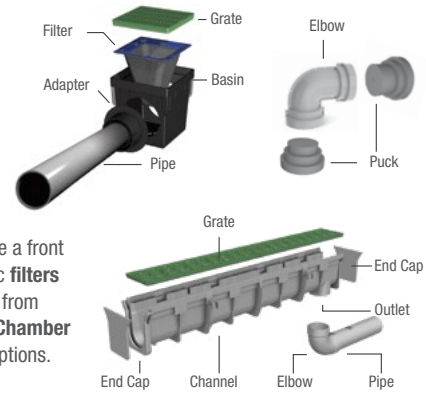

FILTRATION

Basins and channel grates provide a front line of debris filtration; adding fabric **filters** contributes further removal of fines from stormwater, extending system life. **Chamber systems** have advanced filtration options.

CONVEYANCE

Smooth-wall and corrugated pipe with compatible fittings and adapters convey stormwater from the point of capture to the detention and infiltration area. Select pipe type and set pipe slope to handle the anticipated runoff volumes based on established pipe-flow characteristics. Using EZflow for conveyance may reduce the footprint of downstream detention and infiltration areas.

DETENTION & INFILTRATION

Flo-Well® manufactured dry wells provide 50 gallons of detention volume. Each unit has multiple connection points including sidewall and top-cover knock outs to receive 3" to 8" pipe. Flo-Well's are stackable and can be arranged in multiple configurations.

EZflow® engineered French drains are 10' bundles of Poly-Rock aggregate with or without corrugated drain pipe. Bundles are available in 7", 10" and 15" diameters, with or without 3", 4" or 6" pipe, respectively. A standard infiltration trench consists of a 10" bundle with 4" pipe atop two 15" aggregate-only bundles, providing over 100 gallons of detention volume.

NDS® StormChamber® provides a lower cost alternative to drainage pipes for conveyance, with added benefits of groundwater recharge and water quality enhancement. Chambers eliminate the need for restrictive holding ponds and can be stacked in many applications to reduce footprint and save valuable land space.

OVERFLOW

Pop-up emitters allow excess runoff beyond system capacity to discharge in a safe location.

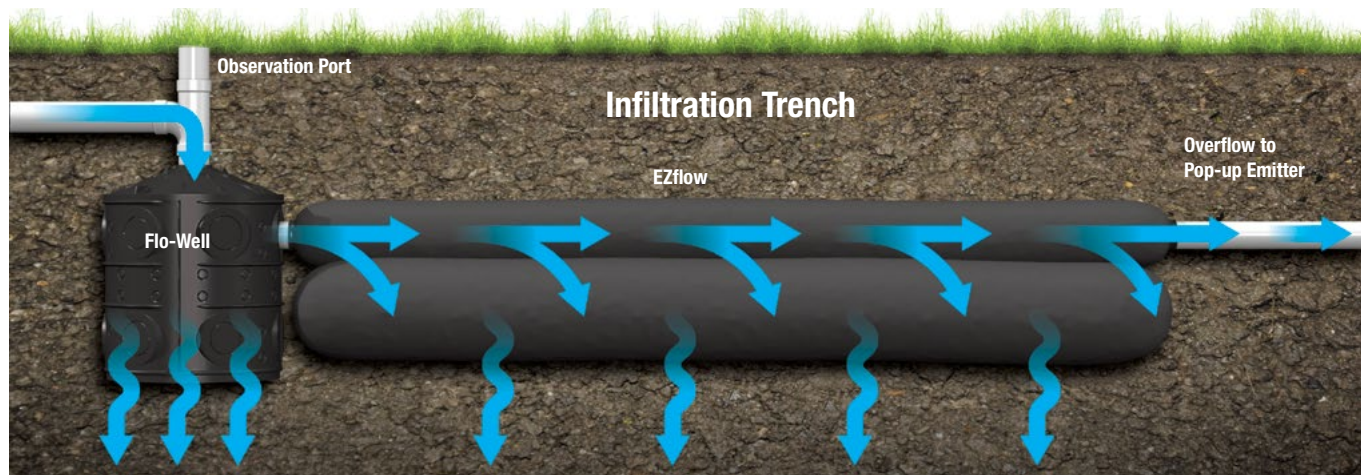

SUSTAINABLE STORMWATER SOLUTIONS

NDS components can be configured to meet a wide variety of residential and commercial applications.

CAPTURE

NDS offers several options to collect stormwater from various sources.

- Catch basins function effectively as area drains and for downspouts from roofs
- Channel drains intercept sheet flow from paved surfaces
- Permeable grass and gravel paver systems with underdrains collect stormwater from walkways and parking areas when used as alternatives to traditional impermeable solutions

FILTER

Prevent debris and other suspended solids in stormwater from impairing system function.

- Basin and channel grates provide a front line of mechanical filtration
- Fabric filters contribute further removal of fines from stormwater, extending system life
- Grass and gravel paver systems naturally filter and clean stormwater while flowing through the permeable paver solutions

CONVEY

Move stormwater from its sources to downstream detention, infiltration and overflow components.

- Smooth-wall and corrugated pipe with appropriate fittings and adapters have known flow characteristics to get the job done
- Using EZflow® for conveyance will also increase system detention and infiltration, effectively reducing the footprint of the downstream detention area

DETAIN

NDS detention components provide efficient volume to minimize runoff and maximize infiltration.

- Flo-Well® dry wells, NDS® StormChamber® and EZflow® infiltration-trench arrangements have defined volumes for this purpose.

INFILTRATE

Arrange Flo-Well® dry wells, NDS® StormChamber® and EZflow® infiltration trenches in customizable configurations and at depths suitable to existing site conditions, soil types and groundwater elevations.

- Flo-Well® has an open bottom and side knockouts to allow direct infiltration, and EZflow® maximizes soil-contact area for effective infiltration

OVERFLOW

Allow for excess stormwater beyond the design storm to overflow from the system in a safe, suitable downstream location.

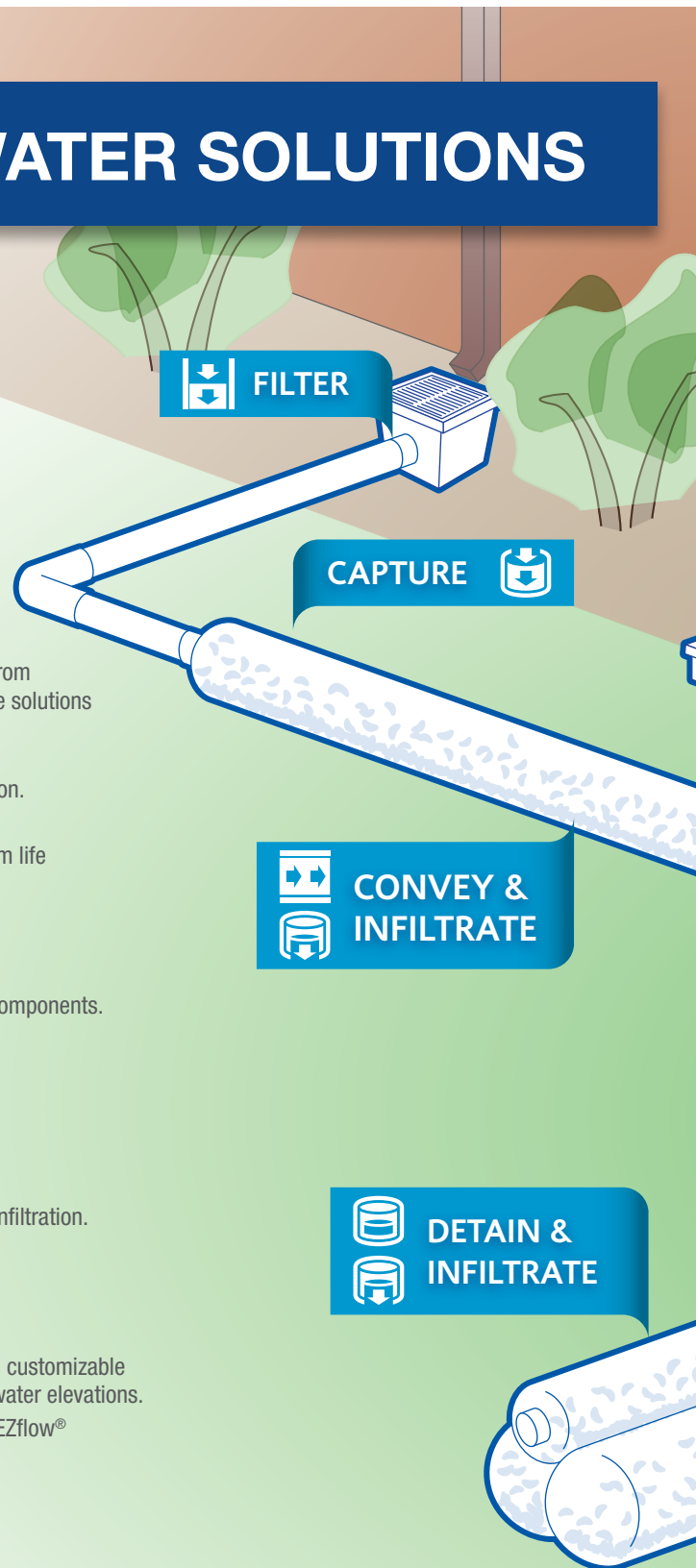

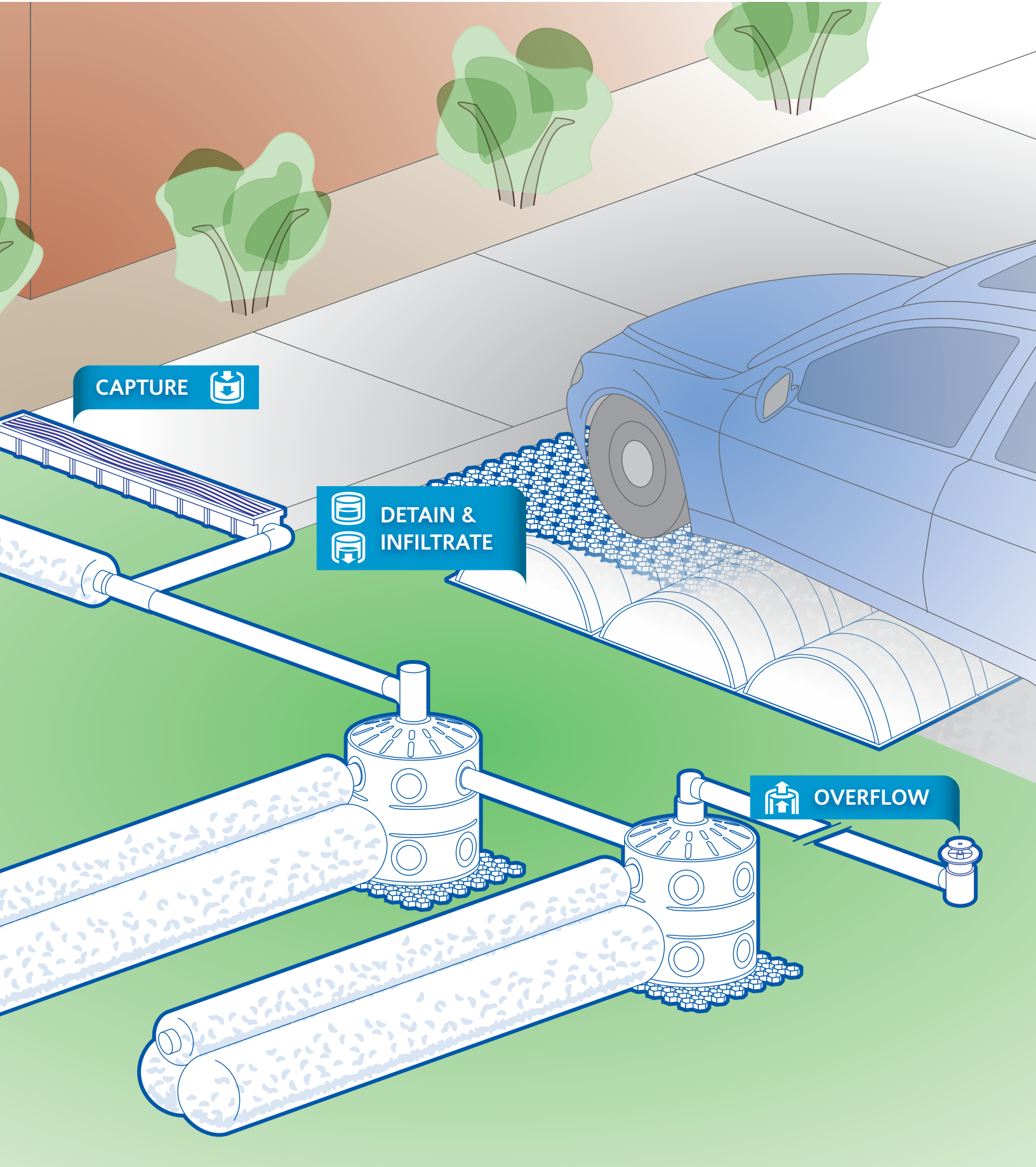

SUBSURFACE DRAINAGE & INFILTRATION



NDS®
StormChamber®

THE NDS SOLUTION

Whether you need a dry well, French drain or infiltration trench, NDS has you covered with innovative and proven subsurface drainage and stormwater infiltration products. EZflow® French drain system, NDS® StormChamber® and Flo-Well® dry well provide trusted performance for multiple applications and are lightweight and easy to install. These engineered solutions are proven time-and-labor savers that outperform traditional systems in flow through and storage capacity. When performance and sustainability matter, NDS solutions are the preferred choice of contractors, engineers and landscape architects. **EZflow®, NDS® StormChamber® and Flo-Well® are made in the USA and each contribute to project LEED credits when used as part of the stormwater management design and by contributing to the proportion of recycled materials.**



DRAINAGE

EZflow®

EZflow® offers an engineered and gravel-free alternative to a traditional French Drain system. EZflow® can be used to lower subsurface groundwater elevations; protecting property and improving the health of playing fields and planted areas. It can also be used as an infiltration trench for managing stormwater runoff. Available in multiple diameters with or without pipe, this versatile product is an effective component of subsurface drainage and infiltration systems.

- Installs in half the time of traditional gravel systems
- Better flow capacity than traditional stone-and-pipe systems
- Up to H-10 load rating with 12" of compacted soil cover
- Over 100 million linear feet installed

NDS® StormChamber®

Stormwater chambers provide a lower cost alternative to drainage pipes for conveyance, with added benefits of groundwater recharge and water quality enhancement. Stronger and easier to maintain, NDS® StormChamber® is the ideal solution for stormwater detention and/or infiltration, providing easy installation and design flexibility to meet target stormwater runoff rates, volume control and water quality requirements.

- Thermo-formed high density weight polyethylene HMWPE material won't crack
- 100-year life expectancy – Longest on the market
- Saves time and money – offers the lowest installed cost
- Proprietary SedimenTrap™ offers centralized sediment control, gathering sediment and pollutants in one place for quick removal by vacuum truck.

Flo-Well®

Flo-Well® engineered dry well presents an easy to install and sustainable solution for managing stormwater runoff. Flo-Well® is a gravel-free alternative to a traditional dry well with up to 250% more detention volume. Used independently or as part of a larger system, Flo-Well® units collect and detain stormwater allowing for groundwater recharge. Units are modular and can be connected in series or stacked to meet a variety of project needs.

- Up to 50 gallons of detention volume per unit
- Connect units in series for larger volumes or stack for reduced footprint
- Fast and easy installation with no heavy equipment or gravel needed
- Manufactured from 100% recycled materials

EZFLOW®: A BETTER FRENCH DRAIN



- Gravel-free installation provides up to 50% labor savings over traditional systems
- Better flow through and detention volume than traditional systems
- Durable with a 100-year materials lifespan when installed
- Projects qualify for LEED credits

EZflow® Drainage Bundles

EZflow® drainage bundles are 10 feet in length with a slotted pipe surrounded by expanded polystyrene aggregate and enclosed in geotextile mesh. Configurations are available in 7-inch bundles with or without a 3-inch pipe, 10-inch bundles with or without a 4-inch pipe, and 15-inch bundles with or without a 6-inch pipe. Accessories include 3-inch, 4-inch, and 6-inch internal couplers and end caps. EZflow® bundles can also be used with internal tees, and internal wyes. The 15-inch bundles are available with the pipe located in the center or bottom of the bundle for varying applications. Unless specifically required by code or other requirement, the pipe can be either centered or at the bottom of the bundle.

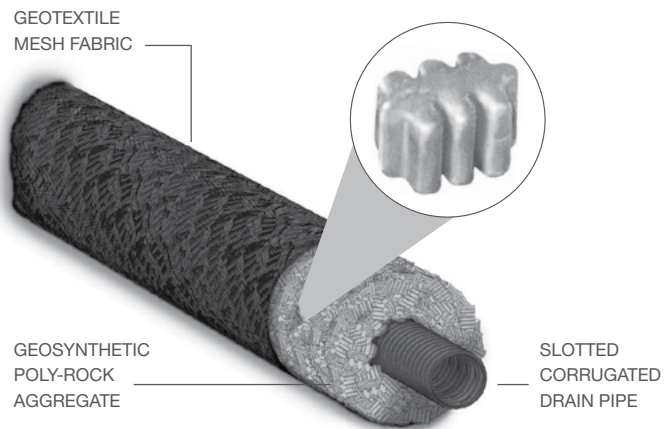

Applications

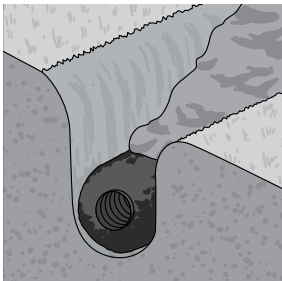

French/Interceptor Drains

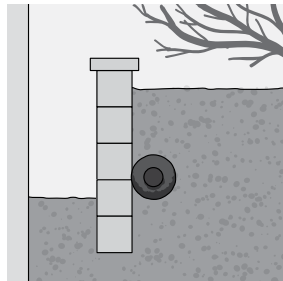

Planter/Retaining Walls

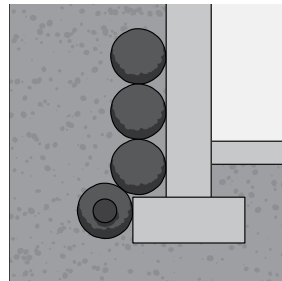

Foundation Drains

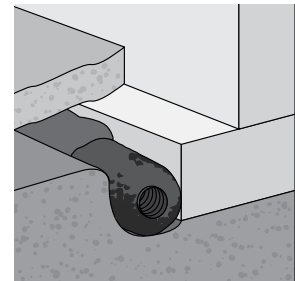

Basement/Crawlspace

EZflow® drainage systems are appropriate for a wide range of applications and are a convenient alternative to traditional stone and pipe drainage, storage and infiltration systems. EZflow® drainage systems can be used as a substitute for stone in most applications where the stone is not utilized for structural support. A professional engineer, landscape architect or other qualified design professional should be consulted for complex applications.

Product selection is relative to the desired application and benefits from establishing anticipated flow into, through and out of a proposed drainage system configuration. Selection considerations include: bundle sizing and storage volume, the presence or absence of pipe, pipe size and location within the bundle, and arrangement of bundles. Design factors may include: length of system, watershed area, soil type and permeability, groundwater levels and system discharge opportunities. EZflow® drainage storage volumes and pipe discharge rates are listed on the next page.

EZFLOW® ENGINEERED FRENCH DRAIN

EZflow® Gravel-Free French Drain

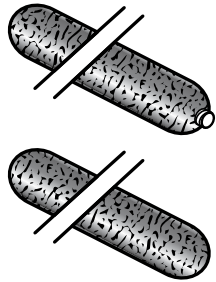

Part No.	Description	Color	Bundle size/ Linear Feet	Wt. per Bundle (lbs.)	Product Class	Specifications
EZ-0701F	7" mesh with 3" slotted pipe (center)	Black	90	32.4	11RP	10 ft. polyethylene slotted drain pipe surrounded by 100% recycled polystyrene aggregate and enclosed in 30-sieve polyethylene geotextile mesh.
EZ-1001F	10" mesh with 4" slotted pipe (center)	Black	50	29.5	11RP	
EZ-1501F	15" mesh with 6" slotted pipe (center)	Black	20	26.0	11RP	
EZ-0701A	7" mesh without pipe – aggregate only	Black	90	18.0	11RP	10 ft. segment of 100% recycled polystyrene aggregate only, enclosed in 30-sieve polyethylene geotextile mesh.
EZ-1001A	10" mesh without pipe – aggregate only	Black	50	13.5	11RP	
EZ-1501A	15" mesh without pipe – aggregate only	Black	20	12.4	11RP	

DRAINAGE

EZflow® Internal Couplings & End Caps

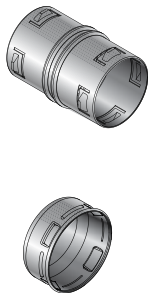

Part No.	Description	Color	Pkg. Qty.	Wt. Ea. (lbs.)	Product Class
3C05	3" Corrugated Internal Coupling	Black	60/box	0.30	11RP
4C07	4" Corrugated Internal Coupling	Black	36/box	0.30	11RP
6C07	6" Corrugated Internal Coupling	Black	12/box	0.80	11RP
3C06	3" Corrugated End Cap	Black	33/box	0.30	11RP
4C06	4" Corrugated End Cap	Black	21/box	0.50	11RP
6C06	6" Corrugated End Cap	Black	15/box	0.50	11RP

Storage & Flow for EZflow® Drainage Bundles *(45% void space among consolidated EPS aggregate)*

Pipe Bundles		
Product	Storage Volume (gallons/10 ft. piece)	Flow Capacity (gpm @ 1% slope)
EZ-0701F	11.4	80.8
EZ-1001F	21.5	130.9
EZ-1501F	45.8	345.0

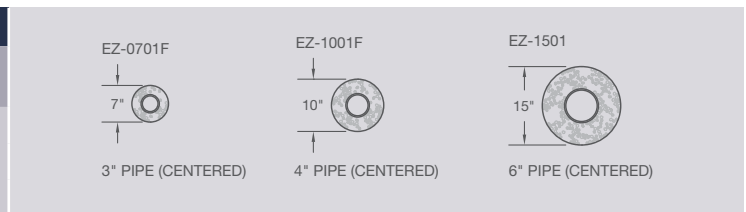

Aggregate-Only Bundles		
Product	Storage Volume (gallons/10 ft. piece)	Flow Capacity (gpm @ 1% slope)
EZ-0701A	8.8	37.1
EZ-1001A	17.2	75.7
EZ-1501A	36.5	170.3

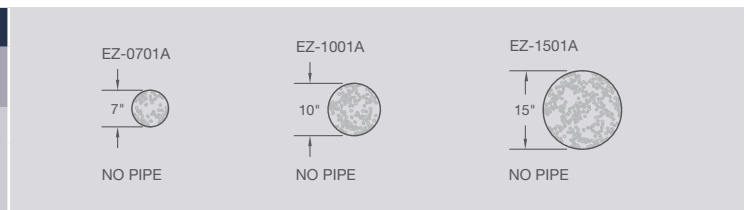

NDS® STORMCHAMBER®: THE MOST COST-EFFECTIVE CHAMBER SOLUTION

DRAINAGE



NDS® StormChambers® are subsurface structures that are used to collect, retain and discharge stormwater on commercial and residential sites. They provide a lower cost alternative to drainage pipes for conveyance, with the added benefits of groundwater recharge and water quality enhancement.

Stronger & Easier to Maintain – High Volume Stormwater Retention

NDS® StormChamber® is the most cost-effective chamber solution on the market. Thermo-formed from high density weight polyethylene HMWPE material, it offers superior strength that won't crack even under the most extreme environments. Designed for fast installation and simple maintenance, NDS® StormChamber® is ideal for roadways, parking lots and fields and can stack, allowing for deeper installation and a smaller footprint.

Key Benefits:



Strong, Flexible & Durable

- Meets H-20 standards
- Up to 16' cover when deep installs are required for the 34". Up to 12' for the 44"
- 100-Year Life Expectancy
- Withstands the most extreme environments
- Material bends instead of breaks, giving it a brittleness temperature of -107° F vs. industry average of -2° F

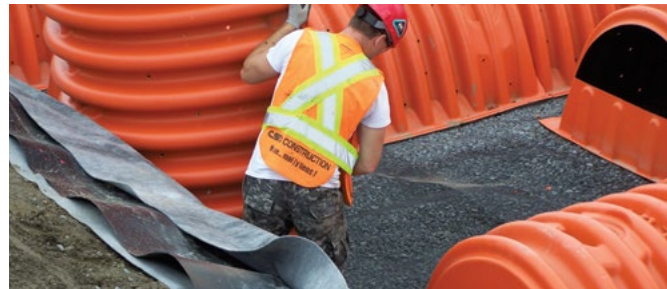

Fast Installation

- Built-in end walls
- No header pipe manifold system required
- Flexible design
- Lowest installed cost

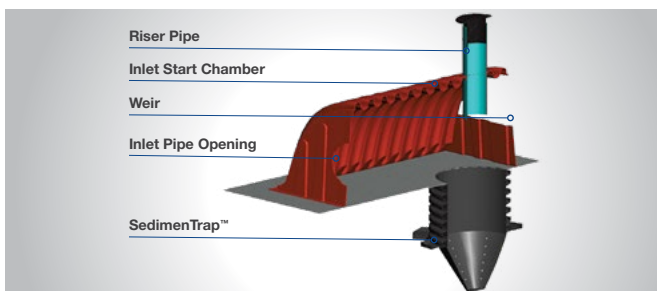

Simple Maintenance

- Differentiated and centralized sediment control
- SedimenTrap™ gathers sediments and other pollutants in one place for quick, easy and inexpensive removal by vacuum truck



Stacks

- 34" Chambers: Capable of 3-layer stacking
- 44" Chambers: Contact NDS DesignWorx for any projects that may need stacking
- We offer expert site-specific design guidance based on 20 years of successful completion of projects

NDS® STORMCHAMBER®

NDS® StormChamber®



Part No.	Description	Color	Length	Width	Height	Weight (lbs.)	Per Pallet	Product Class
SC-3475-S-0	75CUFT START CHAMBER102X60X34	Orange	102"	60"	34"	100	30	10SC
SC-3475-E-0	75CUFT END CHAMBER102X60X34	Orange	102"	60"	34"	100	30	10SC
SC-3475-M-0	75CUFT MIDDLE CHAMBER102X60X34	Orange	102"	60"	34"	100	30	10SC
SC-3475-C-0	75CUFT CLOSE CHAMBER102X60X34	Orange	102"	60"	34"	100	30	10SC
SC-44105-S-0	105CUFT START CHAMBER90X78X44	Orange	90"	78"	44"	120	20	10SC
SC-44105-E-0	105CUFT END CHAMBER90X78X44	Orange	90"	78"	44"	120	20	10SC
SC-44105-M-0	105CUFT MID CHAMBER90X78X44	Orange	90"	78"	44"	120	20	10SC
SC-44105-C-0	105CUFT CLOSE CHAMBER90X78X44	Orange	90"	78"	44"	120	20	10SC
SC-1820-S-0	20CUFT START CHAMBER 18"	Orange	100"	37"	18"	53	45	10SC
SC-1820-E-0	20CUFT END CHAMBER 18"	Orange	100"	37"	18"	53	45	10SC
SC-1820-M-0	20CUFT MIDDLE CHAMBER 18"	Orange	100"	37"	18"	53	45	10SC
SC-1820-C-0	20CUFT CLOSED CHAMBER 18"	Orange	100"	37"	18"	53	45	10SC
SC-ST	SEDIMENT TRAP	Orange	47" OD	-	2'	3	4	10SC
SC-2412P	24" x 12" HDPE Pipe	Orange	24"	-	12"	9.25	20	10SC
SC-NWFF-500	FILTER FABRIC NON-WOVEN LIGHT	Orange	360'	12.5'	1.5' OD roll	220	3	10SC
SC-WFF-75	STABILIZATION FABRIC WOVEN MEDIUM	Orange	75'	7.5'	0.75' OD roll	75	16	10SC
SC-FL-10	10" FRAME AND LID	Orange	20" OD	-	3"	24	-	10SC
SC-3020P	30" X 20" HDPE PIPE	Orange	36" OD	-	20"	45	4	10SC

DRAINAGE

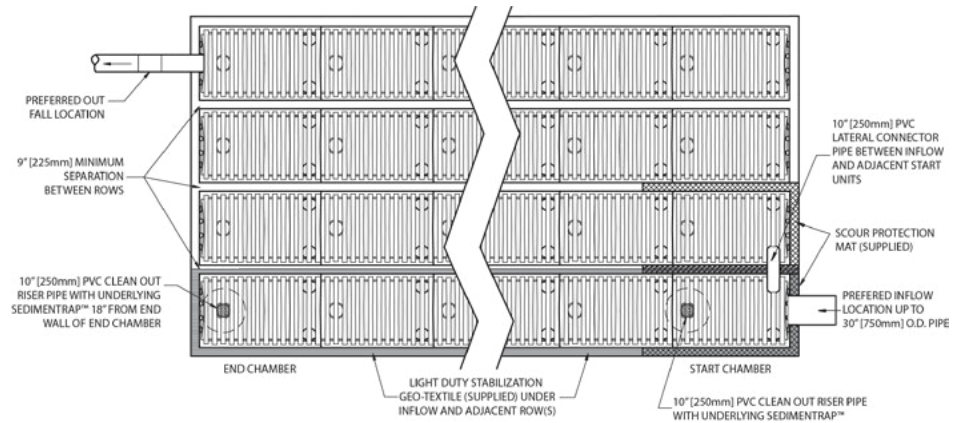

NDS® StormChamber® Elevated View

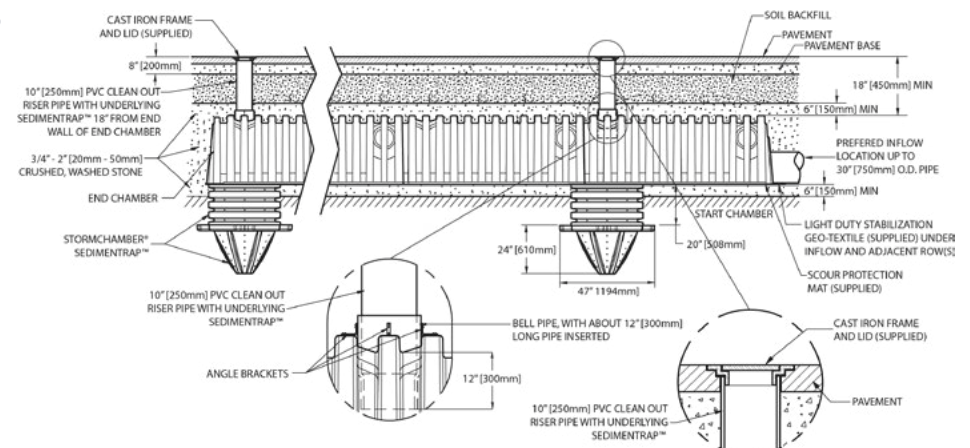

FLO-WELL®: A BETTER DRY WELL

DRAINAGE



With the Flo-Well®, water can now be infiltrated into the subsoil rapidly and easily. Unlike competitive systems, there is no need for piping systems to transport stormwater to a far-off discharge point, large heavy equipment, considerable excavation of current landscaped areas, nor large labor costs that those systems incur. With Flo-Well, water infiltration is now easier than ever.

Options

Larger 9" or 12" grates can be added to Flo-Well to manage surface water.	Ideal as a stand-alone drain:	Ideal as a stand-alone reservoir:
This option is ideal for draining:	Disturbs only 4 square feet of turf to install	Collect and hold rainwater for lawn and garden irrigation (used with a pump connected to a garden hose)
Golf course areas prone to puddling	Requires less than 10 cubic feet of soil removed to bury	Connect Flo-Well to rain gutters using a catch basin & grate below each downspout (see drawing)
Playground areas under slides and swings	Measures only 24" in diameter by 28.75" high	Ideal solution for arid areas impacted by drought
Outdoor drinking fountain runoff	Weighs only 22 pounds	Reservoir for pond and waterfall recirculation pumps
Outdoor showers at beaches	Holds over 48 gallons. Or, connect to existing system for increased drainage capabilities	
Wash-down areas		



Stackable & Expandable

Flo-Well® can be used individually, connected in series or in any array, and can be stacked up to 4 units high (with center support pipe).

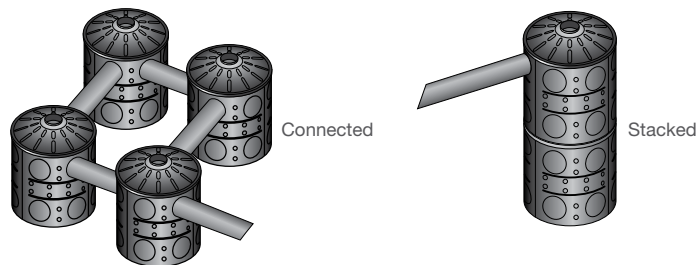

Applications

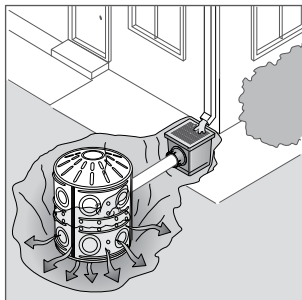

For gutters and downspouts

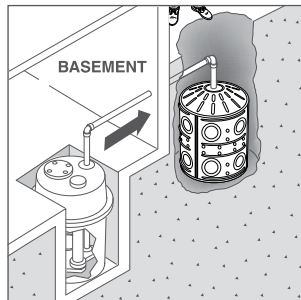

Install with sump pumps

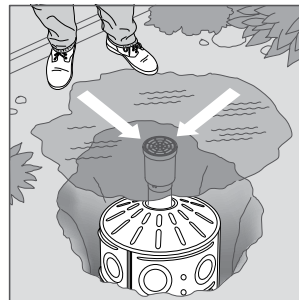

Eliminates puddles

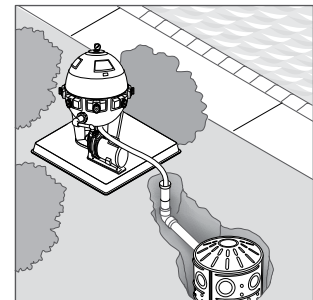

Backwash tank

FLO-WELL® ENGINEERED DRY WELL

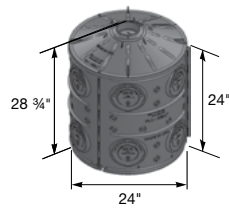

Part No.	Description	Color	Pkg. Qty.	Wt. Ea. (lbs.)	Product Class	Specifications
FWAS24WH	24" diam. x 28.75"H Flo-Well® Stormwater Leaching System	Black	1	18.96	10FW	NDS #FWAS24WH structural foam polyolefin round drywell system with UV inhibitors. 50 gal. storage capacity.
Includes 3 side panels, 1 top component. Fits 4" Sch. 40 Pipe and 4" DWV Pipe.						

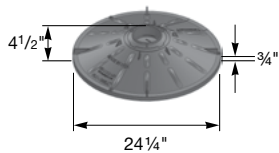

Part No.	Description	Color	Pkg. Qty.	Wt. Ea. (lbs.)	Product Class	Specifications
FWAS24CWH	24" diam. Flo-Well® Cover	Black	2	5.92	10FW	Structural foam polyolefin round drywell system cover with UV inhibitors. 24-1/4" dia., 4-1/2" height, 3/4" outer lip, 4.5" center knockout fits NDS #FWSD69, std pipe and 4" Sch. 40 pipe.
Use with #FWAS24.						

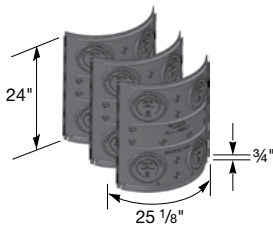

Part No.	Description	Color	Pkg. Qty.	Wt. Ea. (lbs.)	Product Class	Specifications
FWSPS3WH	Flo-Well® Side Panels/Extension Only	Black	1	4.35	10FW	Structural foam polyolefin side panels with UV inhibitors with 22 1-1/2" knockout leaching ports and 4 4.5" knockout inlet/outlet ports per panel. 0.75" lip for firm stacking.
Includes 3 side panels; makes 1 round drywell. (May also be used as a durable compost bin)						

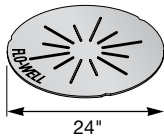

Part No.	Description	Color	Pkg. Qty.	Wt. Ea. (lbs.)	Product Class	Specifications
FWBP24	24" diam. Flo-Well® Bottom	Black	5	3.41	10FW	Structural foam polyolefin round Flo-Well® bottom with UV inhibitors. 24" diameter with six 1-1/2" leaching ports. Collects debris for easy cleanout.
Fits #FWAS24. (Not included in #FWAS24 kit)						

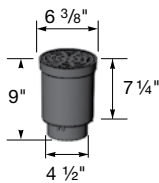

Part No.	Description	Color	Pkg. Qty.	Wt. Ea. (lbs.)	Product Class	Specifications
FWSD69	4" Sch. 40 Surface Drain Inlet with Grate	Black	8	1.85	10FW	Structural foam polyolefin 6" grate with 4" inlet with UV inhibitors. 6" diameter at inlet. 9" high. 4.5" OD fits Sch. 40 PVC fittings. Open surface area 8.22 square inches. 25.15 GPM.
Fits #FWAS24 and #FWAS24C. ADA Compliant.						

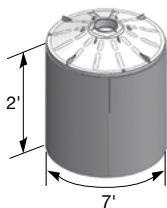

Part No.	Description	Color	Pkg. Qty.	Wt. Ea. (lbs.)	Product Class	Specifications
FWFF67	Porous Filter Fabric Wrap for Flo-Well®	Black	1	0.35	10FW	7' long x 2' wide to surround Flo-Well® Drywell System. Non-woven fabric. Weight 1 oz. Mullen burst 175 psi. 200 GPM flow-through.
Use with #FWAS24.						

CATCH BASINS



NDS catch basins and grates collect surface water while minimizing the amount of debris entering the system

Available in a range of sizes from 6" round to 24" square, and with various grating and filter options for commercial and residential systems.

DRAINAGE

NDS Drainage Solutions

NDS offers a complete line of catch basins and grates for residential and commercial stormwater management solutions. NDS catch basins have sump areas that collect debris and prevent clogging of the pipeline, and grates are available in a variety of patterns and colors to blend in with surrounding surfaces. Depending on the size of the round, square, or atrium grates, they may fit directly into a riser of pipe, sewer and drain fitting, or our catch basins.

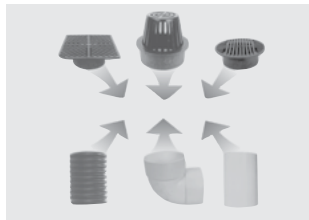

Small Grates

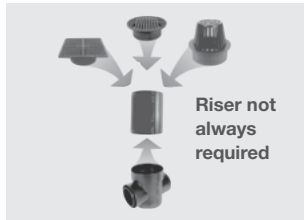

Spee-D® Basin

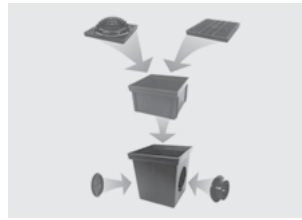

Large Catch Basin

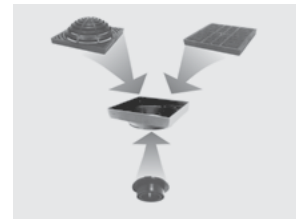

Adapter

Spee-D® Basins

Use our compact 6" round Spee-D Basins with grates to collect runoff water while its sump area collects debris and prevents clogging. Also use Spee-D Basins with 6" Pop-Up Emitters to provide a point of discharge or overflow in a drainage system.

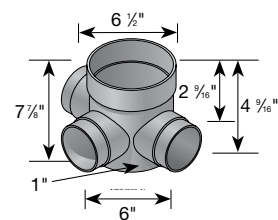
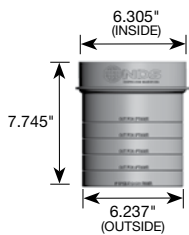
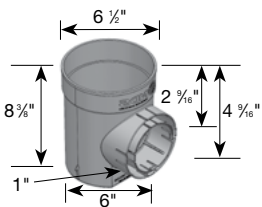

Part No.	Description	Color	Pkg. Qty.	Wt. Ea. (lbs.)	Product Class	Specifications
101	One 3" and 4" Locking Outlet	Black	10	1.60	10ND	6" styrene catch basin with locking outlet. Up to ## GPM per outlet capacity.
101GRKIT	Spee-D Basin with 6" Green Round Grate	Green Grate	6	2.10	10ND	
201	Two 3" and 4" Locking Outlets	Black	10	1.83	10ND	
Spee-D Basins and kits fit 3" or 4" Sewer & Drain Pipe, 3" or 4" Corrugated Pipe, 4" Sch. 40 and 3" & 4" Triple Wall Pipe. Use new Spee-D Riser or 6" Sewer and Drain Pipe as a riser for all 6" round catch basins. Use waterproof silicone to make water-tight connections. Locking Outlet snaps on to most 3" and 4" corrugated pipe.						<p>101 201</p> <p>Kits contain 1-outlet Spee-D Basin & Grate as described.</p>

Part No.	Description	Color	Pkg. Qty.	Wt. Ea. (lbs.)	Product Class	Specifications
101R	Spee-D Basin Riser	Black	12	1.07	10ND	6" Riser for Spee-D Basin. Styrene.
Use with any Spee-D Basin to add from 2" to 6" to top of basin. Can be cut to size and has guidelines in 1" increments. Compatible with all grates that fit Spee-D Basin.						

Part No.	Description	Color	Pkg. Qty.	Wt. Ea. (lbs.)	Product Class	Specifications
250	Two - 4" 90° Outlets	Black	12	1.64	10ND	6" styrene catch basin with pipe outlets. 83 GPM per outlet capacity.
300	Three - 4" Outlets	Black	12	1.82	10ND	
350	Four - 4" Outlets	Black	12	2.00	10ND	
Fit 4" Sewer & Drain pipe and fittings, 4" SCH40 and Corrugated Pipes. Use Spee-D Basin Riser 101R or 6" Sewer & Drain pipe as riser extension.						<p>250 300 350</p>

CATCH BASINS

9" Catch Basin Series

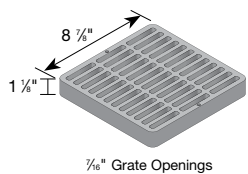
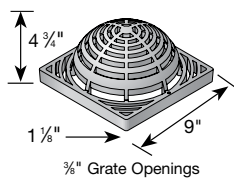
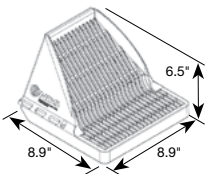
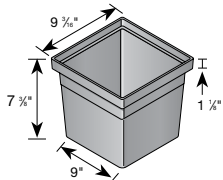
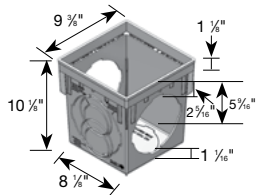

Part No.	Description	Color	Pkg. Qty.	Wt. Ea. (lbs.)	Product Class	Specifications
900FF	9" Catch Basin Filter	Blue Frame/ Black Bag	8	0.06	10ND	Polypropylene Frame Fabric is non-woven geotextile 956 PM/SF.
Compatible with these basins: 900, 900-4 and 916 NDS Catch Basins, Risers and Kits						

Part No.	Description	Color	Pkg. Qty.	Wt. Ea. (lbs.)	Product Class	Specifications
900BLKIT	9" x 9" Catch Basin Kit	Black Grate	4	4.90	10ND	9" x 9" tapered Catch Basin. Polypropylene. Kits include 2-opening Catch Basin, Grate, Screws, 2 Outlets and 1 Plug. DISP includes 4 kits with black grates and 4 green
900GRKIT	9" x 9" Catch Basin Kit	Green Grate	4	4.90	10ND	
900KITDISP	9" x 9" Catch Basin Kits in Display Box	Blk/Grn Grates	8	39.2	10ND	
900	9" x 9" Catch Basin 2-opening	Black	4	2.18	10ND	
900-4	9" x 9" Catch Basin 4-opening	Black	4	2.00	10ND	
Requires either #1206, #1242, #1243, #1245 or #1266 Universal Outlet to connect pipe to basin. (see page 35)						

Part No.	Description	Color	Pkg. Qty.	Wt. Ea. (lbs.)	Product Class	Specifications
916	9" x 9" Catch Basin Riser	Black	4	1.75	10ND	6" Riser for 9" x 9" Catch Basin. Styrene.
Use with 9" x 9" Catch Basin Series. Stacks on top of 9" catch basins to add up to 6" to top of basin. Can be cut to size.						

Part No.	Description	Color	Pkg. Qty.	Wt. Ea. (lbs.)	Product Class	Specifications
900DSG	9" x 9" Downspout Defender Grate	Black	4	0.8	10ND	9" x 9" Downspout Grate, Structural Foam Polyolefin with UV inhibitors. 146 GPM. Receives downspouts from 2" to 4" round or square. Fits all NDS 9" square Catch Basins, Risers and Low-Profile Adapters
900DSGKIT	9" x 9" Low-Profile Downspout Kit	Black	4	2.25	10ND	
Receives downspouts from 2" to 4" round or square. Fits 3" & 4" Corrugated Pipe, 3" & 4" Sewer and Drain Pipe, 4" Sewer and Drain Fittings, 4" Schedule 40 Pipe, and 3" & 4" Triple Wall Pipe.						

Part No.	Description	Color	Pkg. Qty.	Wt. Ea. (lbs.)	Product Class	Specifications
981	9" x 9" Atrium Grate	Black	6	0.87	10ND	9" Structural Foam Polyolefin Dome Atrium Grate with UV inhibitor. Open surface area 31.50 square inches. 96.36 GPM.
991	9" x 9" Atrium Grate	Green	6	0.87	10ND	
Use with 9" x 9" Catch Basin Series.						

Part No.	Description	Color	Pkg. Qty.	Wt. Ea. (lbs.)	Product Class	Specifications
980	9" Square Grate	Black	8	1.50	10ND	9" Square Structural Foam Polyolefin Grate with UV inhibitor. Open surface area 37.49 square inches. 114.69 GPM.
990	9" Square Grate	Green	8	1.50	10ND	
999	9" Square Grate	Gray	8	1.50	10ND	
999S	9" Square Grate	Sand	8	1.50	10ND	
Use with 9" x 9" Catch Basin Series. NDS #980, 990, 999, 999S: Class A Load Rated. ADA Compliant. NDS #930B: Class B Load Rated. (see page 79). ADA Compliant.						

DRAINAGE

CATCH BASINS

9" Catch Basin Series (continued)

DRAINAGE

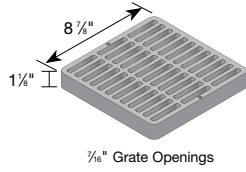

Part No.	Description	Color	Pkg. Qty.	Wt. Ea. lbs.	Product Class	Specifications
930B	9" Square Brass Grate	Brass	1	5.11	15BR	Open surface area 34.00 square inches. 104.01 GPM. Includes SS Screws.
	(see page 79). ADA Compliant.					

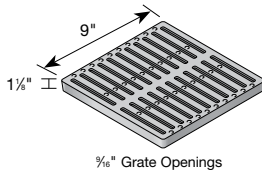

Part No.	Description	Color	Pkg. Qty.	Wt. Ea. (lbs.)	Product Class	Specifications
913	9" Square Ductile Iron Grate	Black*	4	7.89	10ND	9" Square Heavy-Duty Ductile Iron Grate. Open surface area 21.70 square inches. 66.38 GPM.
	Use with 9" x 9" Catch Basin Series. *Painted for shipping & display only; grate will form iron-oxide patina (see page 79)					

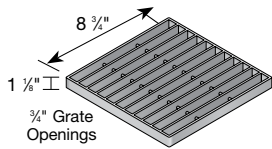

Part No.	Description	Color	Pkg. Qty.	Wt. Ea. (lbs.)	Product Class	Specifications
915	9" Square Galvanized Steel Grate	Galvanized Steel	4	3.80	10ND	9" Square Heavy-Duty Galvanized Steel Bar Grate. Open surface area 61.94 square inches. 189.48 GPM.
	Use with 9" x 9" Catch Basin Series. (see page 79)					

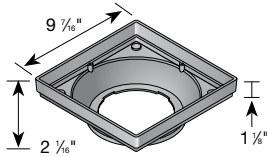

Part No.	Description	Color	Pkg. Qty.	Wt. Ea. (lbs.)	Product Class	Specifications
930	9" x 9" Low-Profile Adapter	Black	8	0.75	10ND	9" x 9" Low-Profile Adapter. Styrene.
930GRKIT	9" x 9" Low-Profile Adapter with Flat Green Grate and 3" & 4" Universal Locking Outlet	Green Grate	8	n/a	10ND	Kits contain Low-Profile Adapter, 3" & 4" Universal Locking Outlet and Grate as described.
Adapter alone requires #1242, #1243, #1245, #1266 or #1889 Universal Outlets to connect to 3", 4", 6" or 8" Sewer and Drain or Corrugated Pipes (see page 35). Kits contain #1243 outlet.						

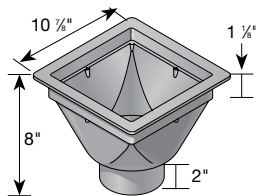

Part No.	Description	Color	Pkg. Qty.	Wt. Ea. (lbs.)	Product Class	Specifications
931	9" x 9" Deep Housing Spigot Adapter	Black	10	2.40	10ND	9" x 9" Square Deep Housing Spigot Adapter. Styrene.
Fits 4" Corrugated Pipe. Use #933 to adapt to 4" Sewer and Drain Pipe.						

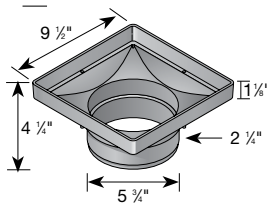

Part No.	Description	Color	Pkg. Qty.	Wt. Ea. (lbs.)	Product Class	Specifications
932	9" x 9" Low-Profile Housing Adapter	Black	8	1.13	10ND	NDS #932, 9" x 9" Square Low-Profile Housing Adapter with 6" Outlet. Styrene.
Fits 6" Spee-D® Basin and 6" Sewer and Drain Pipe & Fittings.						

CATCH BASINS

12" Catch Basin Series

DRAINAGE



Part No.	Description	Color	Pkg. Qty.	Wt. Ea. (lbs.)	Product Class	Specifications
1200FF	12" Catch Basin Filter	Blue Frame/ Black Bag	8	0.10	10ND	Polypropylene Frame Fabric is non-woven geotextile 956 PM/SF.
Compatible with all NDS 12"x12" grates except plastic botanical 1218, 1218GR, 1218GY, 1218S.						

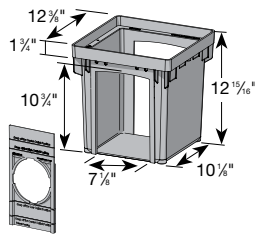

Part No.	Description	Color	Pkg. Qty.	Wt. Ea. (lbs.)	Product Class	Specifications
1200GBKIT	12" x 12" Catch Basin, 2 Open Slides	Black	4	4.65	10ND	Adjustable Outlet Catch Basin. Sides adjust to 3 different outlet elevations. Polypropylene basin and styrene sides.
Compatible with 12" x 12" Catch Basin Risers and Grates.						

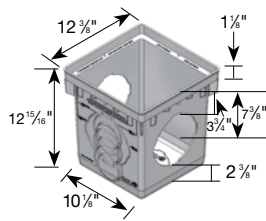

Part No.	Description	Color	Pkg. Qty.	Wt. Ea. (lbs.)	Product Class	Specifications
1200BLKIT	12" x 12" Catch Basin Kit	Black Grate	4	7.59	10ND	12" x 12" Tapered Catch Basin. Polypropylene.
1200GRKIT	12" x 12" Catch Basin Kit	Green Grate	4	7.59	10ND	
1200KITDISP	12" x 12" Catch Basin Kits in Display Box	Blk/Grn Grates	8	7.59	10ND	Kits include 2-opening Catch Basin, Grate, Screws, 2 Outlets and 1 Plug. DISP includes 4 kits with black grates and 4 green
1200	12" x 12" Catch Basin, 2 Openings	Black	4	4.25	10ND	
1203	12" x 12" Catch Basin, 3 Openings	Black	4	3.75	10ND	
1204	12" x 12" Catch Basin, 4 Openings	Black	4	3.75	10ND	
Requires either #1206, #1242, #1243, #1245, #1266 or #1889 Universal Outlet to connect pipe to basin (see page 35). Bottom cutout can be removed.						

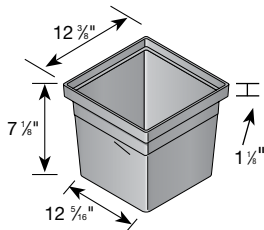

Part No.	Description	Color	Pkg. Qty.	Wt. Ea. (lbs.)	Product Class	Specifications
1216	12" x 12" Catch Basin Riser	Black	8	2.75	10ND	6" Riser for 12" Catch Basin. Styrene.
Use with 12" x 12" Catch Basin Series. Stacks on top of 12" catch basins to add up to 6" to top of basin. Can be cut to size.						

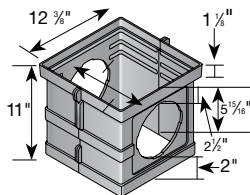

Part No.	Description	Color	Pkg. Qty.	Wt. Ea. (lbs.)	Product Class	Specifications
1217	12" x 12" Riser with 2 Openings	Black	4	4.00	10ND	12" Riser with Two Openings. Styrene.
Nests on top of 12" Catch Basin Series for shallow outlets and 12" Sump Box for more sump area. Requires either #1206, #1242, #1243, #1245, #1266 or #1889 Universal Outlet to connect pipe to riser.						

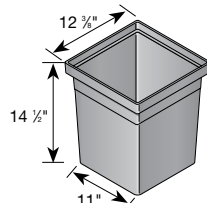

Part No.	Description	Color	Pkg. Qty.	Wt. Ea. (lbs.)	Product Class	Specifications
1225	12" x 12" Sump Box	Black	4	6.75	10ND	One-piece 12" Sump Box. Styrene.
Use with 12" x 12" Grate or #1220 Sump/Valve Box Cover.						

CATCH BASINS

12" Catch Basin Series (continued)

DRAINAGE

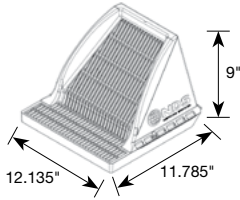

Part No.	Description	Color	Pkg. Qty.	Wt. Ea. (lbs.)	Product Class	Specifications
1200DSG	12" x 12" Downspout Defender Grate	Black	8	n/a	10ND	12" x 12" Downspout Grate. Structural Foam Polyolefin with UV inhibitor. 247 GPM.
Receives downspouts from 2" to 6" round or square. Fits all NDS 12" square Catch Basins, Risers and Low-Profile adapters.						

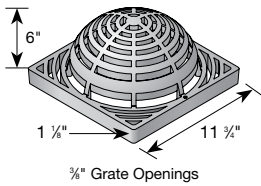

Part No.	Description	Color	Pkg. Qty.	Wt. Ea. (lbs.)	Product Class	Specifications
1280	12" x 12" Atrium Grate	Green	8	1.74	10ND	12" Structural Foam Polyolefin Dome Atrium Grate with UV inhibitor. Open surface area 50.60 square inches. 154.79 GPM.
1290	12" x 12" Atrium Grate	Black	8	1.74	10ND	
Use with 12" x 12" Catch Basin Series.						

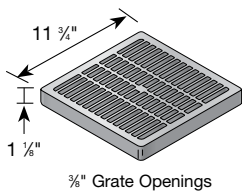

Part No.	Description	Color	Pkg. Qty.	Wt. Ea. (lbs.)	Product Class	Specifications
1210	12" x 12" Square Grate	Gray	8	2.33	10ND	12" Square Structural Foam Polyolefin Grate with UV inhibitor. Open surface area 50.76 square inches. 155.28 GPM.
1211	12" x 12" Square Grate	Black	8	2.33	10ND	
1212	12" x 12" Square Grate	Green	8	2.33	10ND	
1212S	12" x 12" Square Grate	Sand	8	2.33	10ND	
Use with 12" x 12" Catch Basin Series. (see page 79). ADA Compliant.						

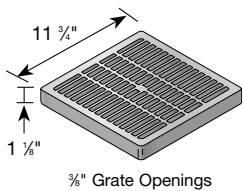

Part No.	Description	Color	Pkg. Qty.	Wt. Ea. (lbs.)	Product Class	Specifications
1230B	12" Square Brass Grate	Brass	1	9.24	15BR	Open surface area 42.87 square inches. 131.14 GPM. Includes SS Screws.
(see page 79). ADA Compliant.						

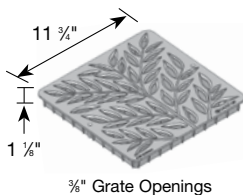

Part No.	Description	Color	Pkg. Qty.	Wt. Ea. (lbs.)	Product Class	Specifications
1218S	12" x 12" Square Botanical Grate	Sand	8	3.27	10ND	12" Square Structural Foam Polyolefin Botanical Grate with UV inhibitor. Open surface area 24.44 square inches. 74.77 GPM. Class B load rated.
1218GR	12" x 12" Square Botanical Grate	Green	8	3.27	10ND	
1218GY	12" x 12" Square Botanical Grate	Gray	8	3.27	10ND	
1218	12" x 12" Square Botanical Grate	Black	8	3.27	10ND	
839	Stainless Steel Screws, FH #6 x 1-3/4"	Metal	40/Bag	n/a	10ND	
(see page 79). ADA Compliant. Not compatible with 1200FF filter.						

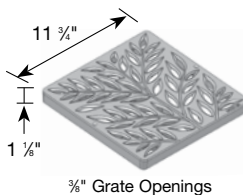

Part No.	Description	Color	Pkg. Qty.	Wt. Ea. (lbs.)	Product Class	Specifications
1218CI	12" x 12" Square Botanical Cast Iron Grate	Black*	1	12.67	10ND	12" Square Cast Iron Botanical Grate. Open surface area 24.44 square inches. 74.77 GPM. Class B load rated.
629	Stainless Steel Screws, FH #20 x 1-1/2"	Metal	40/Bag	n/a	10ND	
*Painted for shipping & display only; grate will form iron-oxide patina (see page 79). ADA Compliant.						

CATCH BASINS

12" Catch Basin Series (continued)

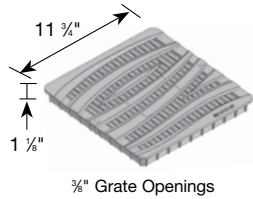

Part No.	Description	Color	Pkg. Qty.	Wt. Ea. (lbs.)	Product Class	Specifications
1224S	12" x 12" Square Wave Grate	Sand	8	2.68	10ND	12" Square Structural Foam Polyolefin Wave Grate with UV inhibitor. Open surface area 25.67 square inches. 78.53 GPM. Class B load rated.
1224GR	12" x 12" Square Wave Grate	Green	8	2.68	10ND	
1224GY	12" x 12" Square Wave Grate	Gray	8	2.68	10ND	
1224	12" x 12" Square Wave Grate	Black	8	2.68	10ND	
839	Stainless Steel Screws, FH #6 x 1-3/4"	Metal	40	n/a	10ND	
 (see page 79). ADA Compliant. Compatible with 1200FF filter.						

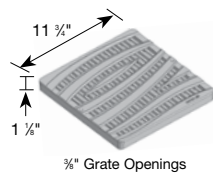

Part No.	Description	Color	Pkg. Qty.	Wt. Ea. (lbs.)	Product Class	Specifications
1224CI	12" x 12" Square Wave Cast Iron Grate	Black*	1	13.90	10ND	12" Square Cast Iron Wave Grate. Open surface area 25.60 square inches. 78.31 GPM. Class B load rated.
629	Stainless Steel Screws, FH #20 x 1-1/2"	Metal	40	n/a	10ND	
 *Painted for shipping & display only; grate will form iron-oxide patina (see page 79). ADA Compliant/Heel-proof.						

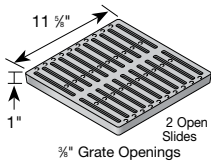

Part No.	Description	Color	Pkg. Qty.	Wt. Ea. (lbs.)	Product Class	Specifications
1213	12" x 12" Square Ductile Iron Grate	Black*	1	15.30	10ND	12" Square Heavy-Duty Ductile Iron Grate. Open surface area 37.20 square inches. 113.80 GPM.
 Use with 12" x 12" Catch Basin Series. *Painted for shipping & display only; grate will form iron-oxide patina (see page 79). ADA Compliant.						

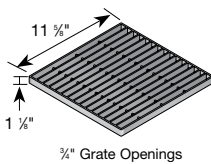

Part No.	Description	Color	Pkg. Qty.	Wt. Ea. (lbs.)	Product Class	Specifications
1215	12" x 12" Square Galvanized Steel Grate	Galvanized Steel	1	5.85	10ND	12" Square Heavy-Duty Galvanized Steel Bar Grate. Open surface area 113.78 square inches. 348.07 GPM.
 Use with 12" x 12" Catch Basin Series. (see page 79)						

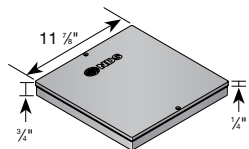

Part No.	Description	Color	Pkg. Qty.	Wt. Ea. (lbs.)	Product Class	Specifications
1220	12" x 12" Sump/Valve Box Cover	Black	8	2.23	10ND	NDS #1220, 12" Square Structural Foam Polyolefin Solid Cover.
Use with NDS 12" x 12" Catch Basin Series, #1225 Sump Box and #1219 Backwater Valve Box.						

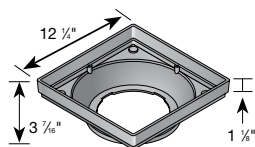

Part No.	Description	Color	Pkg. Qty.	Wt. Ea. (lbs.)	Product Class	Specifications
1230	12" x 12" Low-Profile Adapter	Black	8	1.25	10ND	12" x 12" Low-Profile Adapter. Styrene.
Adapter #1242, #1243, #1245, #1266 or #1889 Universal Outlets to connect to 3", 4", 6" or 8" Sewer and Drain or Corrugated Pipes (see page 35).						

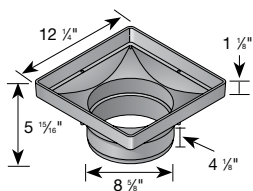

Part No.	Description	Color	Pkg. Qty.	Wt. Ea. (lbs.)	Product Class	Specifications
1222	12" x 12" Square, Low-Profile Spigot Adapter – Fits 8" single-wall corrugated pipe, sewer and drain pipe and Schedule 40 pipe and dual-wall N-12 corrugated pipe	Black	12	1.92	10ND	12" x 12" Low-Profile Adapter. Styrene.
Use with NDS 12" x 12" Grates						

CATCH BASINS

18" Catch Basin Series

DRAINAGE

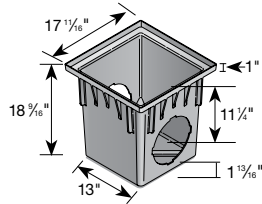

Part No.	Description	Color	Pkg. Qty.	Wt. Ea. (lbs.)	Product Class	Specifications
1882	18" One-Piece Catch Basin 2 Openings	Black	1	10.00	10ND	18"x18" One-Piece Tapered Catch Basin. Structural Foam Polyolefin. Kits include 2-opening Catch Basin, Grate, Screws, 6" Outlet, 8" Outlet, Reducer Rings and Plug
1882BLKIT	18" Catch Basin Kit with Black Plastic Grate	Black Grate		21.00	10ND	
1882GRKIT	18" Catch Basin Kit with Green Plastic Grate	Green Grate	1	21.00	10ND	
1884	18" One-Piece Catch Basin 4 Openings	Black	1	9.65	10ND	
Requires either #1206, #1242, #1243, #1245, #1266, #1888 or #1889 Universal Outlet to connect pipe to basin. Includes 2 or 4 #1890 Reducer Rings.						

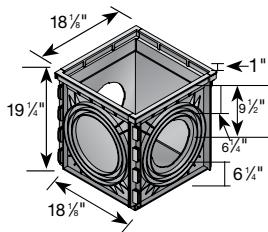

Part No.	Description	Color	Pkg. Qty.	Wt. Ea. (lbs.)	Product Class	Specifications
1800	18" x 18" Expandable Catch Basin 2 Openings*	Black	1	16.00	10ND	18" x 18" Modular Catch Basin with Locking Tabs. Styrene.
1804	18" x 18" Expandable Catch Basin 4 Openings*	Black	1	16.00	10ND	
Assembly Required. #1800 includes: 2 #1822, 2 #1820, 1 #1828. #1804 includes: 4 #1822, 1 #1828. Use #1800 and #1804 with #1206, #1243, #1245, #1266 or #1888 Universal Outlets to connect pipes to basin. Includes 2 or 4 #1890 Reducer Rings. (Note: Use Silicone to seal joints.)						

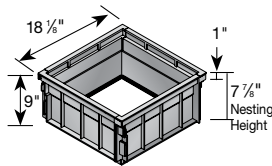

Part No.	Description	Color	Pkg. Qty.	Wt. Ea. (lbs.)	Product Class	Specifications
1816	8" Riser for 18" Catch Basin	Black	1	6.00	10ND	8" Riser for 18" x 18" Catch Basin. Styrene.
Riser package includes 4 sides. Use with #1800, #1804, #1882 or #1884.						

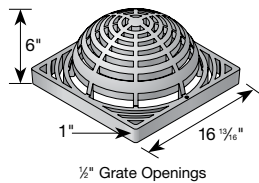

Part No.	Description	Color	Pkg. Qty.	Wt. Ea. (lbs.)	Product Class	Specifications
1881	18" x 18" Atrium Grate	Black	2	6.51	10ND	18" Structural Foam Polyolefin Dome Atrium Grate with UV inhibitor. Open surface area 89.40 square inches. 273.49 GPM.
1891	18" x 18" Atrium Grate	Green	2	6.51	10ND	
Use with 18" x 18" Catch Basin Series.						

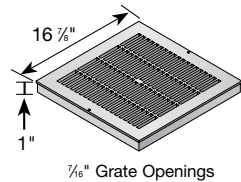

Part No.	Description	Color	Pkg. Qty.	Wt. Ea. (lbs.)	Product Class	Specifications
1810	18" x 18" Square Grate	Gray	4	7.72	10ND	18" Square Structural Foam Polyolefin Grate with UV inhibitor. Open surface area 86.31 square inches. 264.03 GPM.
1811	18" x 18" Square Grate	Black	4	7.72	10ND	
1812	18" x 18" Square Grate	Green	4	7.72	10ND	
Use with 18" x 18" Catch Basin Series. (see page 79). ADA Compliant.						

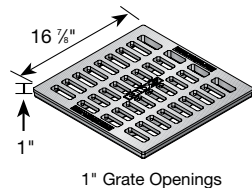

Part No.	Description	Color	Pkg. Qty.	Wt. Ea. (lbs.)	Product Class	Specifications
1813	18" x 18" Cast Iron Square Grate	Black*	1	46.00	10ND	18" Square Heavy-Duty Cast Iron Grate. Open surface area 110.70 square inches. 338.65 GPM. H-20 Load Rating.
Use with 18" x 18" Catch Basin Series. *Painted for shipping & display only; grate will form iron-oxide patina						

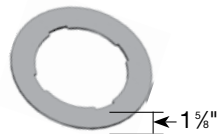

Part No.	Description	Color	Pkg. Qty.	Wt. Ea. (lbs.)	Product Class	Specifications
1890	Universal Outlet Reducer Ring	Black	8	0.33	10ND	Styrene.
Required on #1821 basin side when using 3", 4" or 6" pipe. Required on #1821 basin side when connecting to #1206, #1243, #1245, #1266 or #1889 Universal Outlets.						

CATCH BASINS

18" Catch Basin Series (continued)

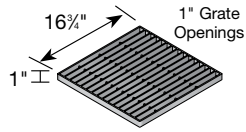

Part No.	Description	Color	Pkg. Qty.	Wt. Ea. (lbs.)	Product Class	Specifications
1815	18" Square Galvanized Steel Grate	Galvanized Steel	1	10.78	10ND	18" Square Heavy-Duty Galvanized Steel Bar Grate. Open surface area 239.00 square inches. 731.13 GPM.
 Use with 18" x 18" Catch Basin Series. (see page 79)						

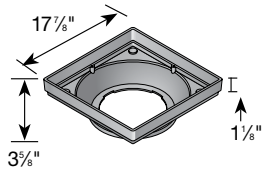

Part No.	Description	Color	Pkg. Qty.	Wt. Ea. (lbs.)	Product Class	Specifications
1830	18" x 18" Low-Profile Adapter	Black	4	4.75	10ND	18" x 18" Low-Profile Adapter. Styrene.
Includes NDS #1890 Reducer Ring. Requires either an NDS #1243, #1245, #1266 or #1888 Universal Outlet to connect to pipe.						

CATCH BASINS

24" Catch Basin Series

DRAINAGE

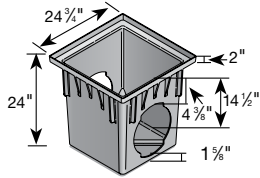

Part No.	Description	Color	Pkg. Qty.	Wt. Ea. (lbs.)	Product Class	Specifications
2400	24" x 24" Catch Basin, 2 Openings	Black	1	18.00	10ND	24" x 24" One-Piece Tapered Catch Basin. HDPE with Structural Foam.
2400BLKIT	24" Catch Basin Kit with Black Plastic Grate	Black Grate		50.00	10ND	
2400GRKIT	24" Catch Basin Kit with Green Plastic Grate	Green Grate	1	50.00	10ND	
2404	24" x 24" Catch Basin, 4 Openings	Black	1	15.00	10ND	Kits include 2-opening Catch Basin, Grate, 12"/10" Outlets, 8" Outlet, Reducer Rings and Plug
#2400 & #2404 Require 2 or 4 #2410 Universal Outlets.						

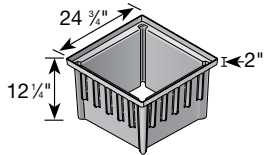

Part No.	Description	Color	Pkg. Qty.	Wt. Ea. (lbs.)	Product Class	Specifications
2418	24" x 24" Catch Basin Extension (No Bottom)	Black	1	14.60	10ND	8" Extension for 24" x 24" Catch Basin. HDPE with Structural Foam.
Use with 24" x 24" Catch Basin Series.						

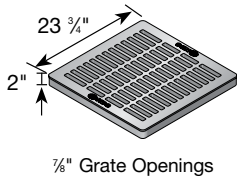

Part No.	Description	Color	Pkg. Qty.	Wt. Ea. (lbs.)	Product Class	Specifications
2411	24" x 24" Square Grate	Black	1	19.75	10ND	24" Square HDPE with Structural Foam Grate with UV inhibitor. Open surface area 231.69 square inches. 708.77 GPM.
2412	24" x 24" Square Grate	Green	1	19.75	10ND	
Use with 24" x 24" Catch Basin Series. (see page 79)						

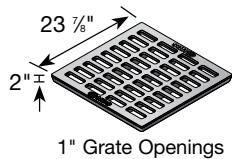

Part No.	Description	Color	Pkg. Qty.	Wt. Ea. (lbs.)	Product Class	Specifications
2413	24" x 24" Square Cast Iron Grate	Black*	1	147.00	10ND	24" Square Heavy-Duty Cast Iron Grate. Open surface area 197.00 square inches. 602.65 GPM. Structural Foam.
Use with 24" x 24" Catch Basin Series. *Painted for shipping & display only; grate will form iron-oxide patina (see page 79)						

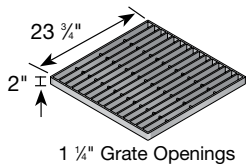

Part No.	Description	Color	Pkg. Qty.	Wt. Ea. (lbs.)	Product Class	Specifications
2415	24" x 24" Square Galvanized Steel Grate	Galvanized Steel	1	62.88	10ND	24" Square Heavy-Duty Galvanized Steel Bar Grate. Open surface area 422.45 square inches. 1292.33 GPM. Structural Foam.
Use with 24" x 24" Catch Basin Series. (see page 79)						

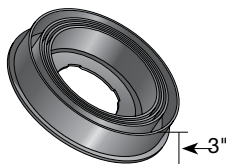

Part No.	Description	Color	Pkg. Qty.	Wt. Ea. (lbs.)	Product Class	Specifications
2410	10" & 12" Universal Adapter	Black	1	4.20	10ND	10"/12" Universal Adapter. HDPE.
Includes #1890 (comes pre-inserted). Fits 10" and 12" Sewer and Drain Pipe; 10" and 12" Dual Wall Corrugated Pipe; 12" Single Wall Corrugated Pipe (does not fit 10" Single Wall Corrugated Pipe). Reduces opening to fit most 3" to 8" adapters above (all except #1889) for use with 3", 4", 6" and 8" Sewer and Drain Pipe; 3", 4", 6" and 8" Corrugated Pipe; and 4" Sch. 40 Pipe (select corresponding adapter above). Use with 24" Catch Basin Series.						

CATCH BASINS

Catch Basin Universal Outlets

Universal Outlets and Adapters allow you to quickly connect to 3"-12" drain pipes to accommodate the needs of any job. They offer greater flexibility during install saving time and money.

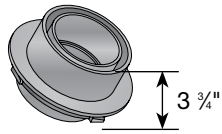

Part No.	Description	Color	Pkg. Qty.	Wt. Ea. (lbs.)	Product Class	Specifications
1242	3" & 4" Universal Outlet w/4" Internal Spigot	Black	20	0.74	10ND	3" & 4" Universal Outlet. Styrene.
Fits 3" & 4" Corrugated Pipe, 3" & 4" Sewer and Drain Pipe, 4" Sch. 40 Pipe, 4" Triple Wall Pipe. Allows for adjusting internal basin invert heights with Sewer and Drain fitting. Use with 9", 12", 18" and 24" Catch Basin Series. Internal spigot fits 4" Sewer and Drain Fittings. Use with 24" Catch Basin also requires #2410 Adapter.						

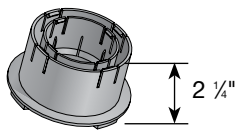

Part No.	Description	Color	Pkg. Qty.	Wt. Ea. (lbs.)	Product Class	Specifications
1243	3" & 4" Universal Locking Outlet*	Black	20	0.60	10ND	3" & 4" Patented Universal Locking Outlet. Styrene.
Fits 3" & 4" Corrugated Pipe, 3" & 4" Sewer and Drain Pipe, 4" Sch. 40 Pipe and 3" & 4" Triple Wall Pipe. Use with 9", 12", 18" and 24" Catch Basin Series and #930, #1230, #1830 and #2410 Adapters. Use with 24" Catch Basin also requires #2410 Adapter.						
*Locking Outlet snaps on to most 3" and 4" corrugated pipe.						

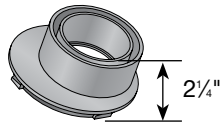

Part No.	Description	Color	Pkg. Qty.	Wt. Ea. (lbs.)	Product Class	Specifications
1245	3" & 4" Offset Universal Outlet	Black	20	0.50	10ND	3" & 4" Offset Universal Outlet. Styrene.
Fits 3" & 4" Corrugated Pipe, 3" & 4" Sewer and Drain Pipe, 4" Sch. 40 Pipe, 4" Triple Wall Pipe. Allows for adjusting inlet height. Use with 9", 12", 18" and 24" Catch Basin Series. Use with 24" Catch Basin also requires #2410 Adapter.						

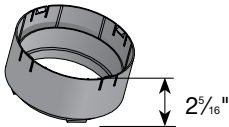

Part No.	Description	Color	Pkg. Qty.	Wt. Ea. (lbs.)	Product Class	Specifications
1266	6" Universal Locking Outlet*	Black	20	0.55	10ND	6" Universal Locking Outlet. Styrene.
Fits 6" Sewer and Drain Pipe, 6" Corrugated Pipe. Use with 9", 12", 18" and 24" Catch Basin Series and #930, #1230 and #1830 Low-Profile Adapters. Use with 24" Catch Basin also requires #2410 Adapter.						
*Locking Outlet snaps on to most 6" corrugated pipe.						

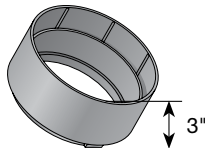

Part No.	Description	Color	Pkg. Qty.	Wt. Ea. (lbs.)	Product Class	Specifications
1888	8" Universal Outlet	Black	8	1.05	10ND	8" Universal Outlet. Styrene.
Fits 8" Sewer and Drain Pipe, 8" Corrugated Pipe. Use with 18" and 24" Catch Basin Series. Use with 24" Catch Basin also requires #2410 Adapter.						

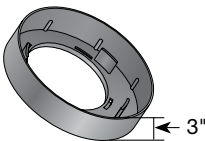

Part No.	Description	Color	Pkg. Qty.	Wt. Ea. (lbs.)	Product Class	Specifications
1889	8" Offset Universal Adapter	Black	10	0.74	10ND	8" Offset Universal Adapter. Styrene.
Fits 8" Sewer and Drain Pipe, 8" Corrugated Pipe. Use with 12" and most 18" Catch Basin Series (except 1800 and 1804).						

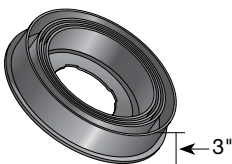

Part No.	Description	Color	Pkg. Qty.	Wt. Ea. (lbs.)	Product Class	Specifications
2410	10" & 12" Universal Adapter	Black	1	4.20	10ND	10"/12" Universal Adapter. HDPE.
Includes #1890 (comes pre-inserted). Fits 10" and 12" Sewer and Drain Pipe; 10" and 12" Dual Wall Corrugated Pipe; 12" Single Wall Corrugated Pipe (does not fit 10" Single Wall Corrugated Pipe). Reduces opening to fit most 3" to 8" adapters above (all except #1889) for use with 3", 4", 6" and 8" Sewer and Drain Pipe; 3", 4", 6" and 8" Corrugated Pipe; and 4" Sch. 40 Pipe (select corresponding adapter above). Use with 24" Catch Basin Series.						

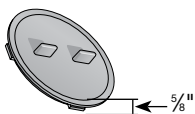

Part No.	Description	Color	Pkg. Qty.	Wt. Ea. (lbs.)	Product Class	Specifications
1206	6" Universal Adapter Plug	Black	20	0.35	10ND	Universal Plug. Styrene.

POP-UP DRAINAGE EMITTERS

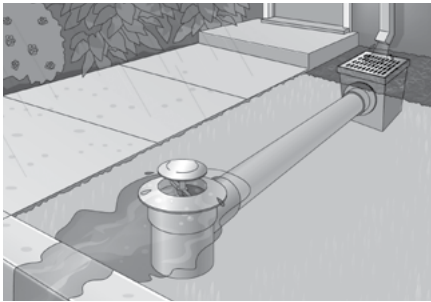

The Pop-up Drainage Emitter is an easy, safe and efficient solution that allows water to be diverted and released to water-safe areas away from structures, erosion-prone landscapes and poor drainage areas.

Pop-up Drainage Emitters allow water captured by grates, catch basins, channel drains, Flo-Well, EZflow, downspouts and roof gutter systems to flow through drainage pipe and away from structural foundations to safe or useful areas. For example, water can be routed from a low area next to a foundation to a water-safe area in the landscape, or a curbside drainage system where allowed. The emitter opens under minimal hydrostatic pressure from water through upstream drainage pipes; the emitter closes as flow diminishes. The special patented design allows the Emitter to open with even the smallest flows. Since the Emitter is closed during dry weather, debris and rodents cannot enter the drain pipes. Spring automatically retracts – closes and prevents damage from lawn mowers. It's flat profile blends discreetly into the surrounding landscapes.

3" & 4" Pop-up Drainage Emitter

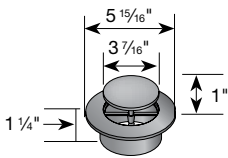

Part No.	Description	Color	Pkg. Qty.	Wt. Ea. (lbs.)	Product Class	Specifications
420	3" & 4" Pop-up Drainage Emitter Fits 3" and 4" Sewer and Drain Fittings. Ideal for discharging excess water from stormwater management system. Spring automatically retracts.	Green	20	0.28	10ND	3" and 4" polyolefin spring-loaded Pop-up Drainage Emitter with UV inhibitor. 75 GPM outflow capacity with 3" system head. 0.04 psi or 1" of head to raise top.

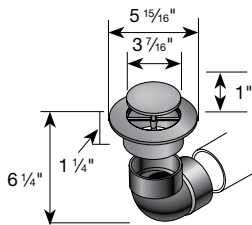

Part No.	Description	Color	Pkg. Qty.	Wt. Ea. (lbs.)	Product Class	Specifications
321	Emitter with 3" Elbow Fits 3" Sewer and Drain Pipe. Ideal for discharging excess water from stormwater management system. Spring automatically retracts.	Green	25	0.60	10ND	NDS #420 polyolefin spring-loaded Pop-up Drainage Emitter with UV inhibitor, 3" styrene 90 degree elbow with 1/4" drain hole. 53 GPM outflow capacity with 3" system head. 0.04 psi or 1" of head to raise top.

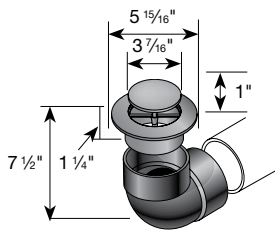

Part No.	Description	Color	Pkg. Qty.	Wt. Ea. (lbs.)	Product Class	Specifications
421	Emitter with 4" Elbow Fits 4" Sewer and Drain Pipe. Ideal for discharging excess water from stormwater management system. Spring automatically retracts.	Green	20	0.85	10ND	NDS #420 polyolefin spring-loaded Pop-up Drainage Emitter with UV inhibitor, 4" styrene 90 degree elbow with 1/4" drain hole. 75 GPM outflow capacity with 3" system head. 0.04 psi or 1" of head to raise top.

POP-UP DRAINAGE EMITTERS

3" & 4" Pop-up Drainage Emitter (continued)

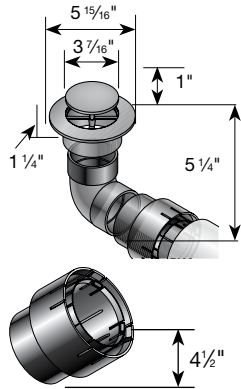

Part No.	Description	Color	Pkg. Qty.	Wt. Ea. (lbs.)	Product Class	Specifications
430	Pop-up Drainage Emitter with 3" Elbow and Universal Adapter	Green	20	1.00	10ND	NDS #420 polyolefin spring-loaded Pop-up Drainage Emitter with UV inhibitor, 3" styrene 90 degree elbow with 1/4" drain hole and universal pipe adapter. 53 GPM outflow capacity with 3" system head. 0.04 psi or 1" of head to raise top.
1241	3" & 4" Universal Adapter w/4" Spigot	Black	20	0.70	10ND	3" & 4" Patented Universal Adapter. Styrene.

6" Pop-up Drainage Emitter

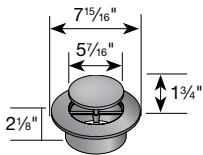

Part No.	Description	Color	Pkg. Qty.	Wt. Ea. (lbs.)	Product Class	Specifications
620	6" Pop-up Drainage Emitter	Green	15	0.61	10ND	6" polyolefin spring-loaded Pop-up Drainage Emitter with UV inhibitor. 170 GPM outflow capacity with 3" system head. 0.04 psi or 1" of head to raise top.

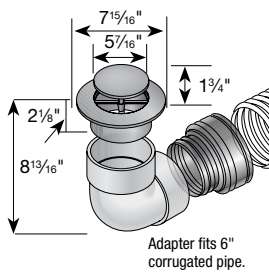

Part No.	Description	Color	Pkg. Qty.	Wt. Ea. (lbs.)	Product Class	Specifications
624	6" Pop-up Emitter with Elbow and Corrugated Pipe Adapter	Green	10	3.45	10ND	NDS #620 polyolefin spring-loaded Pop-up Drainage Emitter with UV inhibitor, 6" styrene 90 degree elbow with 1/4" drain hole and corrugated pipe adapter. 170 GPM outflow capacity with 3" system head. 0.04 psi or 1" of head to raise top.

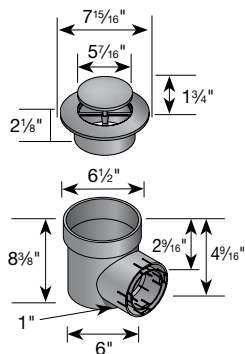

Part No.	Description	Color	Pkg. Qty.	Wt. Ea. (lbs.)	Product Class	Specifications
625	6" Pop-up Emitter with Spee-D® Basin	Green	8	2.21	10ND	NDS #620 polyolefin spring-loaded Pop-up Drainage Emitter with UV inhibitor and Spee-D basin. 170 GPM outflow capacity with 3" system head. 0.04 psi or 1" of head to raise top.

DRAINAGE

COMMON DRAINAGE FITTINGS

90 Degree PVC Elbow

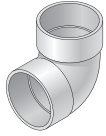

Part No.	Description	Color	Pkg. Qty.	Wt. Ea. (lbs.)	Product Class
3P02	3" PVC 90 Degree Elbow (HUB x HUB)	White	40	0.40	30PV
4P02	4" PVC 90 Degree Elbow (HUB x HUB)	White	25	0.68	30PV
6P02	6" PVC 90 Degree Elbow (HUB x HUB)	White	12	3.00	30PV

Corrugated Adapter

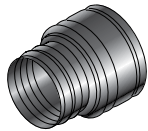

Part No.	Description	Color	Pkg. Qty.	Wt. Ea. (lbs.)	Product Class
351	3" Polyethylene Corrugated Adapter (CORR HUB x S&D SPT or HUB)	Black	50	0.10	30ST
451	4" Polyethylene Corrugated Adapter (CORR HUB x S&D SPT or HUB)	Black	25	0.20	30ST
651	6" Polyethylene Corrugated Adapter (CORR HUB x S&D SPT or HUB)	Black	12	0.25	30ST

Corrugated Internal Couplings

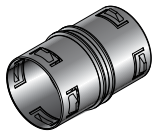

Part No.	Description	Color	Pkg. Qty.	Wt. Ea. (lbs.)	Product Class
3C05	3" Corrugated Coupling	Black	60	0.07	30PE
4C07	4" Corrugated Coupling	Black	36	0.08	30PE
6C07	6" Corrugated Coupling	Black	12	0.08	30PE

Corrugated End Caps



Part No.	Description	Color	Pkg. Qty.	Wt. Ea. (lbs.)	Product Class
3C06	3" Corrugated Endcap	Black	33	0.05	30PE
4C06	4" Corrugated Endcap	Black	30	0.06	30PE
6C06	6" Corrugated Endcap	Black	15	0.50	30PE

Note: See Fittings section (pages 168-187) for additional fitting options.

GRATES: STANDARD, DECORATIVE & METAL



NDS offers a variety of grates in sizes, patterns, colors and design options to fit all products and enhance any landscape.

Brass & Chrome Grates



Strong – Practical – Functional

Our solid cast brass grates are secured to a PVC collar with solid brass screws for aesthetics and reliability. The PVC collar can be solvent welded into sewer and drain fittings or pipe where permanent, anti-theft installation is desired. The grate can still be removed for easy cleanout.

- A unique mix of beauty and function
- Recommended for highly-visible entry areas in hotels, malls, office buildings, country clubs and estates
- Exceptional construction and fine finish also make these grates ideal for deck areas, walkways, swimming pools and spas

Materials & Standards

- Made with the highest-quality solid brass
- Brushed Satin and Polished Chrome finishes are protected by a clear plastic film that prevents damage to the finish during shipping and installation

GRATES: STANDARD, DECORATIVE & METAL

Brass & Chrome Grates

DRAINAGE

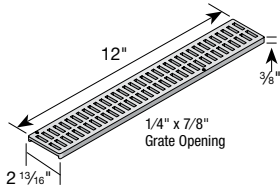

Part No.	Description	Color	Pkg. Qty.	Wt. Ea. lbs.	Product Class	Specifications
552B	1 ft. Brass Channel Grate	Satin Brass	12	1.21	25PF	1 foot Mini Channel Solid Brass Grate with brass screws. Open surface area 9.20 square inches per foot. 28.14 GPM per foot.
553PB	1 ft. Brass Channel Grate	Polished Brass	12	1.21	25PF	
 Fits #500 and #550 Mini Channels. (see pages 50). (see page 79). ADA Compliant/Heel-proof.						

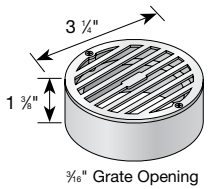

Part No.	Description	Color	Pkg. Qty.	Wt. Ea. lbs.	Product Class	Specifications
909B	3" Round Brass Grate w/PVC Collar	Satin Brass	20	0.40	15BR	3" Round Solid Brass Grate and brass screws with PVC collar. Open surface area 2.68 square inches. 8.20 GPM.
905PB	3" Round Brass Grate w/PVC Collar	Polished Brass	20	0.40	15BR	
 Fits 2" SCH-40 Pipe and 3" Sewer and Drain Fittings. (see page 79). ADA Compliant/Heel-proof.						

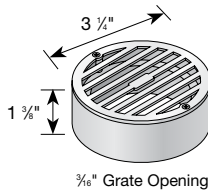

Part No.	Description	Color	Pkg. Qty.	Wt. Ea. lbs.	Product Class	Specifications
915SC	3" Round Chrome Grate w/PVC Collar	Satin Chrome	20	0.40	15BR	3" Round Solid Chrome Grate and screws with PVC collar. Open surface area 2.68 square inches. 8.20 GPM.
907PC	3" Round Chrome Grate w/PVC Collar	Polished Chrome	20	0.40	15BR	
 Fits 3" Sewer and Drain Fittings and 2" SCH-40 Pipe. (see page 79). ADA Compliant/Heel-proof.						

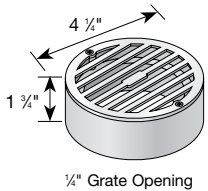

Part No.	Description	Color	Pkg. Qty.	Wt. Ea. lbs.	Product Class	Specifications
910B	4" Round Brass Grate w/PVC Collar	Satin Brass	20	0.64	15BR	4" Round Solid Brass Grate and brass screws with PVC collar. Open surface area 5.25 square inches. 16.06 GPM.
906PB	4" Round Brass Grate w/PVC Collar	Polished Brass	20	0.64	15BR	
 Fits 3" Sewer & Drain Pipe, 4" Sewer & Drain Fittings. (see page 79). ADA Compliant/Heel-proof.						

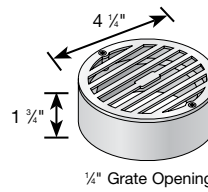

Part No.	Description	Color	Pkg. Qty.	Wt. Ea. lbs.	Product Class	Specifications
917SC	4" Round Chrome Grate w/PVC Collar	Satin Chrome	20	0.66	15BR	4" Round Chrome Grate and screws with PVC collar. Open surface area 5.25 square inches. 16.06 GPM.
908PC	4" Round Chrome Grate w/PVC Collar	Polished Chrome	20	0.66	15BR	
 Fits 3" Sewer & Drain Pipe, 4" Sewer & Drain Fittings. (see page 79). ADA Compliant/Heel-proof.						

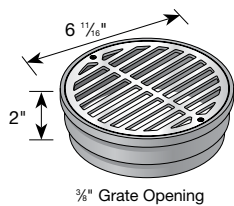

Part No.	Description	Color	Pkg. Qty.	Wt. Ea. lbs.	Product Class	Specifications
918B	6" Round Brass Grate w/Styrene Collar	Satin Brass	8	1.38	15BR	6" Round Solid Brass Grate and brass screws with styrene collar. Open surface area 13.10 square inches. 40.07 GPM.
919PB	6" Round Brass Grate w/Styrene Collar	Polished Brass	8	1.38	15BR	
 Fits Spee-D® Basin, 6" Sewer & Drain Fittings. (see page 79). ADA Compliant.						

GRATES: STANDARD, DECORATIVE & METAL

Brass & Chrome Grates (continued)

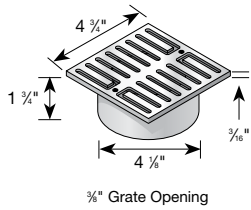

Part No.	Description	Color	Pkg. Qty.	Wt. Ea. lbs.	Product Class	Specifications
913B	5" Square Brass Grate w/PVC Collar	Satin Brass	10	1.21	15BR	5" Square Solid Brass Grate with brass screws and PVC collar. Open surface area 2.5 square inches. 7.65 GPM.
914PB	5" Square Brass Grate w/PVC Collar	Polished Brass	10	1.21	15BR	
Fits 4" Sewer and Drain Fittings, 3" Sewer and Drain Pipe, and 3" Triple Wall Pipe. (see page 79). ADA Compliant.						

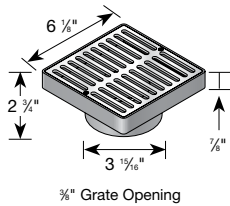

Part No.	Description	Color	Pkg. Qty.	Wt. Ea. lbs.	Product Class	Specifications
920B	6" Square Brass Grate w/Styrene Adapter	Satin Brass	8	1.65	15BR	6" Square Solid Brass Grate with brass-colored styrene low-profile adapter and brass screws. Open surface area 11.60 square inches. 35.49 GPM.
923PB	6" Square Brass Grate w/Styrene Adapter	Polished Brass	8	1.65	15BR	
Fits 3" or 4" Sewer and Drain Pipe or Fittings, 3" or 4" Corrugated Pipe, and 3" or 4" Triple Wall Pipe. (see page 79). ADA Compliant.						

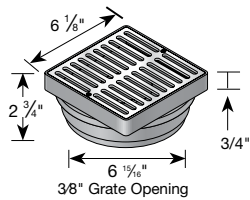

Part No.	Description	Color	Pkg. Qty.	Wt. Ea. lbs.	Product Class	Specifications
921B	6" Square Brass Grate w/Styrene Adapter	Satin Brass	8	1.71	15BR	6" Square Solid Brass Grate with brass-colored styrene low-profile adapter and brass screws. Open surface area 11.60 square inches. 35.49 GPM.
922PB	6" Square Brass Grate w/Styrene Adapter	Polished Brass	8	1.70	15BR	
Fits Spee-D® Basin, 6" Sewer and Drain Pipe & Fittings. (see page 79). ADA Compliant.						

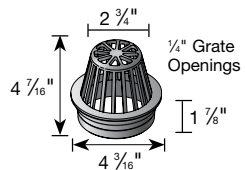

Part No.	Description	Color	Pkg. Qty.	Wt. Ea. lbs.	Product Class	Specifications
78B	4" Atrium Brass Grate	Brass	1	2.00	15BR	Open surface area 10.20 square inches. 31.20 GPM.
Fits 4" Sewer and Drain Pipe & Fittings.						

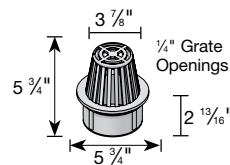

Part No.	Description	Color	Pkg. Qty.	Wt. Ea. lbs.	Product Class	Specifications
90B	6" Atrium Brass Grate	Brass	1	5.30	15BR	Open surface area 22.50 square inches. 68.83 GPM.
Fits 6" Sewer and Drain Pipe & Fittings.						

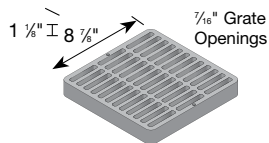

Part No.	Description	Color	Pkg. Qty.	Wt. Ea. lbs.	Product Class	Specifications
930B	9" Square Brass Grate	Brass	1	5.11	15BR	Open surface area 34.00 square inches. 104.01 GPM. Includes SS Screws.
(see page 79). ADA Compliant.						

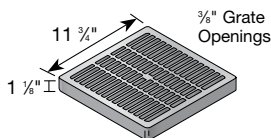

Part No.	Description	Color	Pkg. Qty.	Wt. Ea. lbs.	Product Class	Specifications
1230B	12" Square Brass Grate	Brass	1	9.24	15BR	Open surface area 42.87 square inches. 131.14 GPM. Includes SS Screws.
(see page 79). ADA Compliant.						

GRATES: STANDARD, DECORATIVE & METAL

Decorative Grates

Designed to meet today's demand for products that are as beautiful as they are functional. NDS decorative grates feature consumer-tested designs and offer a range of colors and materials ideal for any application or setting.



DRAINAGE

Catch Basin Plastic & Metal Decorative Grates

Fits 12" Catch Basins. Available in Botanical and Wave designs, in multiple colors or in cast iron. Plastic grates are "T-top" and overlap basin edge. Iron grates sit flush.

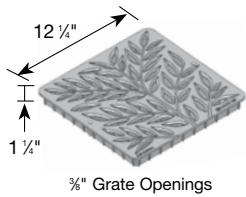

Part No.	Description	Color	Pkg. Qty.	Wt. Ea. (lbs.)	Product Class	Specifications
1218S	12" x 12" Square Botanical Grate	Sand	8	3.27	10ND	12" Square Structural Foam Polyolefin Botanical Grate with UV inhibitor. Open surface area 24.44 square inches. 74.77 GPM. Class B load rated.
1218GR	12" x 12" Square Botanical Grate	Green	8	3.27	10ND	
1218GY	12" x 12" Square Botanical Grate	Gray	8	3.27	10ND	
1218	12" x 12" Square Botanical Grate	Black	8	3.27	10ND	
839	#6 x 1-3/4 FH Phillips Screw	Metal	40	n/a	10ND	
Use Screw # 839, FH#6 x 1-3/4". Not compatible with 1200FF filter. (see page 79). ADA Compliant.						

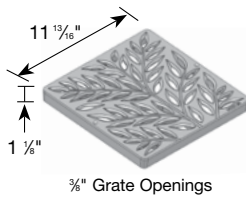

Part No.	Description	Color	Pkg. Qty.	Wt. Ea. (lbs.)	Product Class	Specifications
1218CI	12" x 12" Square Botanical Cast Iron Grate	Black*	1	12.67	10ND	12" Square Cast Iron Botanical Grate. Open surface area 24.44 square inches. 74.77 GPM. Class B load rated.
629	#20 x 1-1/2 FH Phillips Screw	Metal	40	n/a	10ND	
Use Screw # 629, FH#20 x 1-1/2". *Painted for shipping & display only; grate will form iron-oxide patina (see page 79). ADA Compliant.						

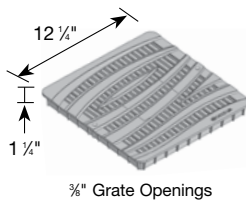

Part No.	Description	Color	Pkg. Qty.	Wt. Ea. (lbs.)	Product Class	Specifications
1224S	12" x 12" Square Wave Grate	Sand	8	2.68	10ND	12" Square Structural Foam Polyolefin Wave Grate with UV inhibitor. Open surface area 25.67 square inches. 78.53 GPM. Class B load rated.
1224GR	12" x 12" Square Wave Grate	Green	8	2.68	10ND	
1224GY	12" x 12" Square Wave Grate	Gray	8	2.68	10ND	
1224	12" x 12" Square Wave Grate	Black	8	2.68	10ND	
839	#6 x 1-3/4 FH Phillips Screw	Metal	40	n/a	10ND	
Use Screw # 839, FH#6 x 1-3/4". Compatible with 1200FF filter. (see page 79). ADA Compliant.						

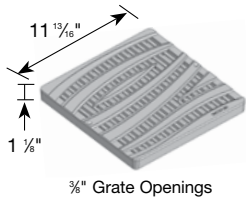



Part No.	Description	Color	Pkg. Qty.	Wt. Ea. (lbs.)	Product Class	Specifications
1224CI	12" x 12" Square Wave Cast Iron Grate	Black*	1	13.90	10ND	12" Square Cast Iron Wave Grate. Open surface area 25.60 square inches. 78.31 GPM. Class B load rated.
629	#20 x 1-1/2 FH Phillips Screw	Metal	40	n/a	10ND	
Use Screw # 629, FH#20 x 1-1/2". *Painted for shipping & display only; grate will form iron-oxide patina (see page 79). ADA Compliant.						

GRATES: STANDARD, DECORATIVE & METAL

Slim Channel Plastic Decorative Grates

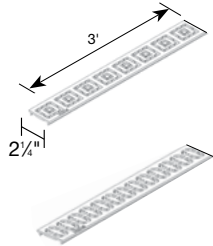
Excellent for light duty applications, including residential pools, concrete and paver patios, spas, walkways and paver landscapes.



Part No.	Description	Color	Pkg. Qty.	Wt. Ea. (lbs.)	Product Class	Specifications
9251	3 ft. Slim Channel Grate Square	White	30 EA (90 LF)	0.36	25PF	3 ft Polypropylene Decorative Square Channel Grate with UV inhibitor. Open Surface Area 5.73 square inches per foot. 21.44 GPM per foot.
9252	3 ft. Slim Channel Grate Square	Sand	30 EA (90 LF)	0.36	25PF	
9253	3 ft. Slim Channel Grate Square	Gray	30 EA (90 LF)	0.36	25PF	
9261	3 ft. Slim Channel Grate Chain	White	30 EA (90 LF)	0.36	25PF	3 ft Polypropylene Decorative Chain Channel Grate with UV inhibitor. Open Surface Area 5.73 square inches per foot. 21.44 GPM per foot.
9262	3 ft. Slim Channel Grate Chain	Sand	30 EA (90 LF)	0.36	25PF	
9263	3 ft. Slim Channel Grate Chain	Gray	30 EA (90 LF)	0.36	25PF	
	(see page 79). ADA Compliant/Heel-proof					

DRAINAGE

Mini Channel Plastic & Metal Decorative Grates

Fits 500 Series Mini Channel. Available in Botanical and Wave designs, in multiple colors or in cast iron.

Plastic grates are "T-top" and overlap basin edge. Iron grates sit flush.

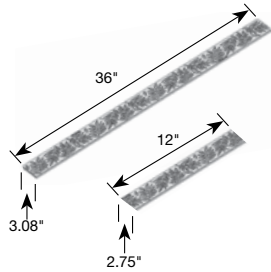

Part No.	Description	Color	Pkg. Qty.	Wt. Ea. (lbs.)	Product Class	Specifications
846	Stainless Steel Screws, FH #4 x 1"	Steel	40/Bag	0.10	25PF	3 ft. Structural Foam Polyolefin botanical pattern Channel Grate with UV inhibitor. Open surface area 5.44 square inches per foot. 16.64 GPM per foot.
554S	3' Botanical Channel Grate	Sand	16	0.89		
554GY	3' Botanical Channel Grate	Gray	16	0.89		
554	3' Botanical Channel Grate	Black	16	0.89		
554CI	1' Botanical Cast Iron Channel Grate	Black*	1	1.82		1 ft. Mini Channel botanical Cast Iron Channel Grate. Open surface area 5.39 square inches per foot. 16.49 GPM per foot. Class B load rated.
529	Stainless Steel Screws, FH #4 x 5/8"	Steel	64/Bag	0.09	25PF	
	*Painted for shipping & display only; grate will form iron-oxide patina (see page 79). ADA Compliant.					

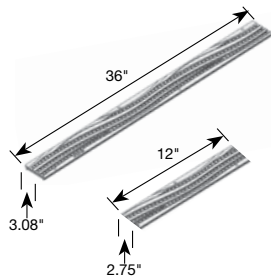

Part No.	Description	Color	Pkg. Qty.	Wt. Ea. (lbs.)	Product Class	Specifications
846	Stainless Steel Screws, FH #4 x 1"	Steel	40/Bag	0.10	25PF	3 ft. Structural Foam Polyolefin wave pattern Channel Grate with UV inhibitor. Open surface area 5.73 square inches per foot. 17.54 GPM per foot.
555S	3' Wave Channel Grate	Sand	16	0.88	25PF	
555GY	3' Wave Channel Grate	Gray	16	0.88		
555	3' Wave Channel Grate	Black	16	0.88		
555CI	1' Wave Cast Iron Channel Grate	Black*	1	1.30		1 ft. Mini Channel Wave Cast Iron Channel Grate. Open surface area 4.11 square inches per foot. 12.56 GPM per foot. Class B load rated.
529	Stainless Steel Screws, FH #4 x 5/8"	Steel	64/Bag	0.09	25PF	
	*Painted for shipping & display only; grate will form iron-oxide patina (see page 79). ADA Compliant.					

GRATES: STANDARD, DECORATIVE & METAL

Spee-D® Channel Plastic & Metal Decorative Grates

Fits Spee-D® Channel. Available in Botanical and Wave designs, in multiple colors or in cast iron. Plastic grates are "T-top" and overlap basin edge. Iron grates sit flush.

DRAINAGE

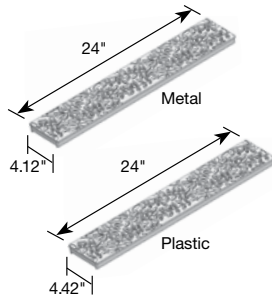

Part No.	Description	Color	Pkg. Qty.	Wt. Ea. (lbs.)	Product Class	Specifications
829	Stainless Steel Screws, FH #6 x 1-1/4"	Steel	40/Bag	0.15	25PF	2 ft. Structural Foam Polyolefin decorative botanical Channel Grate with UV inhibitor. Open surface area 7.78 square inches per foot. 23.80 GPM per foot.
252S	2' Channel Botanical Grate	Sand	24 ft.	1.74	25PF	
252GY	2' Channel Botanical Grate	Gray	24 ft.	1.74	25PF	
252	2' Channel Botanical Grate	Black	24 ft.	1.74	25PF	
252CI	2' Cast Iron Channel Botanical Grate	Black*	1 ft.	7.06	25PF	
229	Stainless Steel Screws, FH #8 x 1"	Steel	48/Bag	0.06	25PF	2 ft. Cast Iron decorative botanical Channel Grate. Open surface area 8.99 square inches per foot. 27.50 GPM per foot. Class B load rated.
*Painted for shipping & display only; grate will form iron-oxide patina (see page 79). ADA Compliant.						

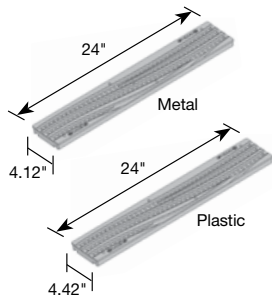

Part No.	Description	Color	Pkg. Qty.	Wt. Ea. (lbs.)	Product Class	Specifications
829	Stainless Steel Screws, FH #6 x 1-1/4"	Steel	40/Bag	0.15	25PF	2 ft. Structural Foam Polyolefin decorative wave Channel Grate with UV inhibitor. Open surface area 7.78 square inches per foot. 23.80 GPM per foot.
253S	2' Channel Wave Grate	Sand	24 ft.	1.84	25PF	
253GY	2' Channel Wave Grate	Gray	24 ft.	1.84	25PF	
253	2' Channel Wave Grate	Black	24 ft.	1.84	25PF	
253CI	2' Cast Iron Channel Wave Grate	Black*	2 ft.	7.52	25PF	
229	Stainless Steel Screws, FH #8 x 1"	Steel	48/Bag	0.06	25PF	2 ft. Cast Iron decorative wave Channel Grate. Open surface area 7.41 square inches per foot. 22.67 GPM per foot. Class B load rated.
*Painted for shipping & display only; grate will form iron-oxide patina (see page 79). ADA Compliant.						

Dura Slope Metal Decorative Grates

Fits all Dura Slope channels. Available in 8 designs: Weave, Tile, Brick, Diamond, Slot, Kiara, Via and Ville. Ductile iron material, rated Class D and ADA compliant.

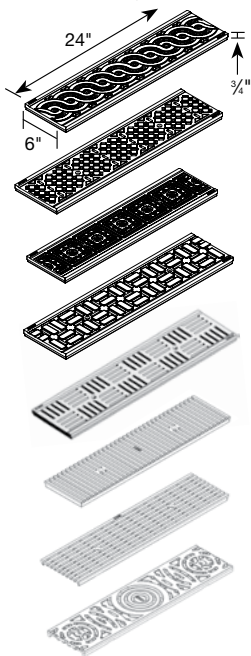

Part No.	Description	Color	Pkg. Qty.	Wt. Ea. (lbs.)	Product Class	Specifications
DS-601	Weave Pattern	Raw Iron	1	14.50	25DS	Decorative grates are made of ductile iron. Weave: open area 6.75 square inches per foot; 20.65 GPM. Diamond: open area 9.55 square inches per foot; 29.21 GPM. Tile: open area 7.95 square inches per foot; 24.32 GPM. Brick: open area 11.35 square inches per foot; 34.725 GPM. Deco slot: open area 16.75 square inches per foot; 51.24 GPM.
DS-602	Diamond Pattern	Raw Iron	1	14.30	25DS	
DS-603	Tile Pattern	Raw Iron	1	14.70	25DS	
DS-604	Brick Pattern	Raw Iron	1	14.30	25DS	
DS-609	Deco Slot	Raw Iron	1	14.50	25DS	
DS-610-KIARO	Kiara Slot	Ductile Iron	120	14.99	25DS	
DS-611-VIA	Via Slot	Ductile Iron	120	10.36	25DS	
DS-612-VILLE	Ville Pattern	Ductile Iron	120	11.68	25DS	
Use with Dura Slope Drains (page 72), Dura Slope Catch Basins (page 74). Decorative grates are made of ductile iron. Uncoated raw iron will develop a rust patina over time. (see page 79). ADA Compliant/Heelproof. Must be used with DS-200H to achieve Class D Load Rating.						

GRATES: STANDARD, DECORATIVE & METAL

Round Grates

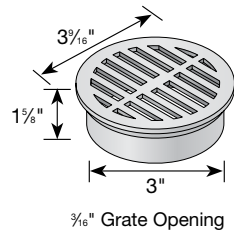

Part No.	Description	Color	Pkg. Qty.	Wt. Ea. lbs.	Product Class	Specifications
14	3" Round Grate	Black	40	0.13	10ND	3" Round Structural Foam Polyolefin Grate with UV inhibitor. Open surface area 2.60 square inches. 7.95 GPM.
15	3" Round Grate	Gray	40	0.13	10ND	
16	3" Round Grate	Green	40	0.13	10ND	
16P	3" Round Grate	Purple	40	0.13	10ND	
16S	3" Round Grate	Sand	40	0.13	10ND	
		 Fits 3" Sewer and Drain Pipe & Fittings, 3" Corrugated Pipe, and 3" Triple Wall Pipe. (see page 79). ADA Compliant/Heel-proof.				

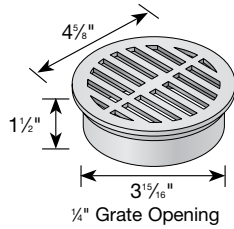

Part No.	Description	Color	Pkg. Qty.	Wt. Ea. lbs.	Product Class	Specifications
11	4" Round Grate	Black	25	0.17	10ND	4" Round Structural Foam Polyolefin Grate with UV inhibitor. Open surface area 3.85 square inches. 11.78 GPM.
12	4" Round Grate	Gray	25	0.17	10ND	
13	4" Round Grate	Green	25	0.17	10ND	
13P	4" Round Grate	Purple	25	0.17	10ND	
13S	4" Round Grate	Sand	25	0.17	10ND	
		 Fits 4" Sewer and Drain Pipe & Fittings, 4" Corrugated Pipe, and 4" Triple Wall Pipe. (see page 79). ADA Compliant/Heel-proof.				

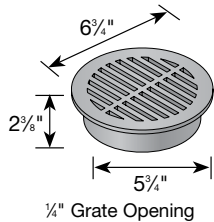

Part No.	Description	Color	Pkg. Qty.	Wt. Ea. lbs.	Product Class	Specifications
40	6" Round Grate	Black	10	0.49	10ND	6" Round Structural Foam Polyolefin Grate with UV inhibitor. Open surface area 9.10 square inches. 27.84 GPM.
50	6" Round Grate	Green	10	0.49	10ND	
60	6" Round Grate	Gray	10	0.49	10ND	
60S	6" Round Grate	Sand	10	0.49	10ND	
		 Fits Spee-D® Basin, 6" Sewer and Drain Pipe & Fittings and 6" Corrugated Pipe. (see page 79). ADA Compliant/Heel-proof.				

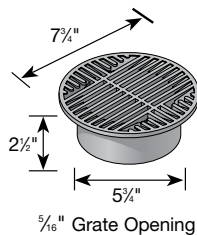

Part No.	Description	Color	Pkg. Qty.	Wt. Ea. lbs.	Product Class	Specifications
10	8" Round Grate	Black	10	0.60	10ND	8" Round Structural Foam Polyolefin Grate with UV inhibitor. Open surface area 11.50 square inches. 35.18 GPM.
20	8" Round Grate	Green	10	0.60	10ND	
30	8" Round Grate	Gray	10	0.60	10ND	
30S	8" Round Grate	Sand	10	0.60	10ND	
		 Fits Spee-D® Basin, 6" Sewer and Drain Pipe & Fittings and 6" Corrugated Pipe. (see page 79). ADA Compliant.				

GRATES: STANDARD, DECORATIVE & METAL

DRAINAGE

Round Grates (continued)

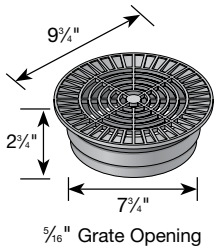

Part No.	Description	Color	Pkg. Qty.	Wt. Ea. lbs.	Product Class	Specifications
1040	10" Round Grate	Black	10	1.01	10ND	10" Round Structural Foam Polyolefin Grate with UV inhibitor. Open surface area 21.57 square inches. 65.99 GPM.
1050	10" Round Grate	Green	10	1.01	10ND	
1060	10" Round Grate	Gray	10	1.01	10ND	
1060S	10" Round Grate	Sand	10	1.01	10ND	
	Fits 8" Sewer and Drain Pipe & Fittings, 8" Corrugated Pipe. (see page 79). ADA Compliant.					

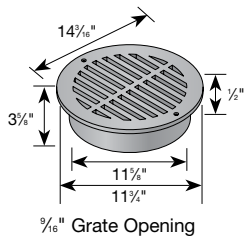

Part No.	Description	Color	Pkg. Qty.	Wt. Ea. lbs.	Product Class	Specifications
1240	12" Round Grate	Black	6	2.44	10ND	12" Round Structural Foam Polyolefin Grate with UV inhibitor. Open surface area 46.00 square inches. 140.72 GPM.
1250	12" Round Grate	Green	6	2.44	10ND	
1260	12" Round Grate	Gray	6	2.44	10ND	
	Fits 12" Sewer and Drain Pipe, 12" Corrugated Pipe. (see page 79)					

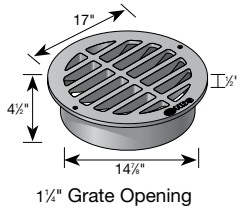

Part No.	Description	Color	Pkg. Qty.	Wt. Ea. lbs.	Product Class	Specifications
1511	15" Round Grate	Black	6	6.89	10ND	15" Round Structural Foam Polyolefin Grate with UV inhibitor. Open surface area 85.60 square inches. 261.86 GPM.
1512	15" Round Grate	Green	6	6.89	10ND	
	Fits 15" Sewer and Drain Fittings, 15" Corrugated Pipe. (see page 79)					

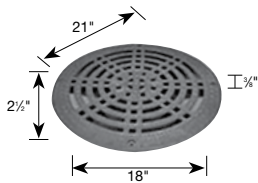

Part No.	Description	Color	Pkg. Qty.	Wt. Ea. lbs.	Product Class	Specifications
1801SDG	18" Round Grate	Green	1	7.50	28ND	Round Polypropylene Grate. Open surface area 75.55 square inches. 231.12 GPM. Includes lag bolts.
	Fits 18" Sewer and Drain Fittings, 18" Corrugated Pipe, includes Lag Bolts. (see page 79)					

GRATES: STANDARD, DECORATIVE & METAL

Atrium Grates

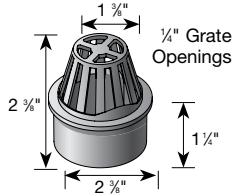

Part No.	Description	Color	Pkg. Qty.	Wt. Ea. lbs.	Product Class	Specifications
270	2" Atrium Grate	Gray	20	0.10	10ND	Flat-Top PVC Atrium Grate with UV inhibitor. Open surface area 4.00 square inches. 12.24 GPM.
Fits 2" Schedule 40 Fittings.						

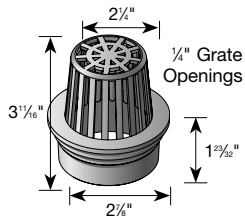

Part No.	Description	Color	Pkg. Qty.	Wt. Ea. lbs.	Product Class	Specifications
70	3" Atrium Grate	Green	20	0.16	10ND	Flat-Top Structural Foam Polyolefin Atrium Grate with UV inhibitor. Open surface area 9.40 square inches. 28.76 GPM.
72	3" Atrium Grate	Gray	20	0.16	10ND	
74	3" Atrium Grate	Black	20	0.16	10ND	
74S	3" Atrium Grate	Sand	20	0.16	10ND	
Fits 3" Sewer and Drain Pipe & Fittings, 3" Corrugated Pipe, and 3" Triple Wall Pipe.						

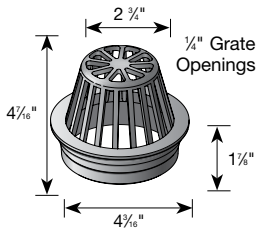

Part No.	Description	Color	Pkg. Qty.	Wt. Ea. lbs.	Product Class	Specifications
75	4" Atrium Grate	Green	20	0.21	10ND	Flat-Top Structural Foam Polyolefin Atrium Grate with UV inhibitor. Open surface area 17.00 square inches. 52.01 GPM.
76	4" Atrium Grate	Gray	20	0.21	10ND	
78	4" Atrium Grate	Black	20	0.21	10ND	
78S	4" Atrium Grate	Sand	20	0.21	10ND	
Fits 4" Sewer and Drain Pipe & Fittings, 4" Corrugated Pipe, and 4" Triple Wall Pipe.						

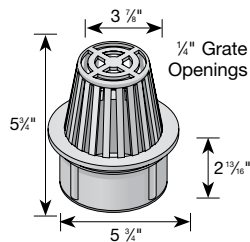



Part No.	Description	Color	Pkg. Qty.	Wt. Ea. lbs.	Product Class	Specifications
80	6" Atrium Grate	Green	10	0.62	10ND	Flat-Top Structural Foam Polyolefin Atrium Grate with UV inhibitor. Open surface area 28.40 square inches. 86.88 GPM.
81	6" Atrium Grate	Gray	10	0.62	10ND	
90	6" Atrium Grate	Black	10	0.62	10ND	
90S	6" Atrium Grate	Sand	10	0.62	10ND	
Fits Spee-D® Basin, 6" Sewer and Drain Pipe & Fittings, 6" Corrugated Pipe.						

GRATES: STANDARD, DECORATIVE & METAL

Square Grates

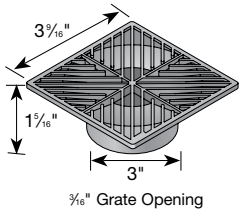
DRAINAGE



Part No.	Description	Color	Pkg. Qty.	Wt. Ea. lbs.	Product Class	Specifications
1	4" Square Grate	Green	40	0.11	10ND	4" Square Structural Foam Polyolefin Grate with diagonally converging pattern with UV inhibitor. Open surface area 3.45 square inches. 10.55 GPM.
2	4" Square Grate	Black	40	0.11	10ND	
3	4" Square Grate	Gray	40	0.11	10ND	
 Fits 3" Sewer and Drain Pipe & Fittings, 3" Corrugated Pipe, and 3" Triple Wall Pipe. (see page 79). ADA Compliant/Heel-proof.						

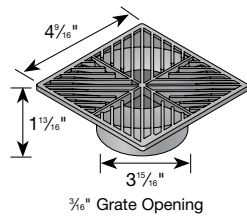

Part No.	Description	Color	Pkg. Qty.	Wt. Ea. lbs.	Product Class	Specifications
7	5" Square Grate	Green	25	0.20	10ND	5" Square Structural Foam Polyolefin Grate with diagonally converging pattern with UV inhibitor. Open surface area 4.25 square inches. 13.00 GPM.
8	5" Square Grate	Black	25	0.20	10ND	
9	5" Square Grate	Gray	25	0.20	10ND	
 Fits 4" Sewer and Drain Pipe & Fittings, 4" Corrugated Pipe, and 4" Triple Wall Pipe. (see page 79). ADA Compliant/Heel-proof.						

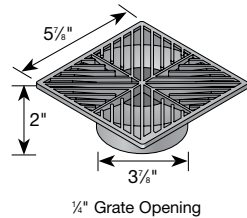

Part No.	Description	Color	Pkg. Qty.	Wt. Ea. lbs.	Product Class	Specifications
4	6" Square Grate	Black	10	0.40	10ND	6" Square Structural Foam Polyolefin Grate with diagonally converging pattern with UV inhibitor. Open surface area 10.40 square inches. 31.81 GPM.
5	6" Square Grate	Green	10	0.40	10ND	
6	6" Square Grate	Gray	10	0.40	10ND	
06S	6" Square Grate	Sand	10	0.40	10ND	
 Fits 3" or 4" Sewer and Drain Pipe, 3" or 4" Corrugated Pipe, and 3" or 4" Triple Wall Pipe. (see page 79). ADA Compliant/Heel-proof.						

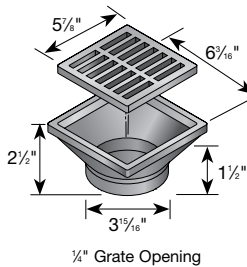

Part No.	Description	Color	Pkg. Qty.	Wt. Ea. lbs.	Product Class	Specifications
640	6" x 6" x 4" Square Grate & Adapter	Black	8	0.83	10ND	6"x6" Low-Profile Adapter and Structural Foam Polyolefin Removable Grate with UV inhibitor and stainless steel screws. Open surface area 14.44 square inches. 44.17 GPM.
641	6" x 6" x 4" Square Grate & Adapter	Green	8	0.83	10ND	
642	6" x 6" x 4" Square Grate & Adapter	Gray	8	0.83	10ND	
 Fits 3" or 4" Sewer and Drain Pipe & Fittings, 3" or 4" Corrugated Pipe, and 3" or 4" Triple Wall Pipe. (see page 79). ADA Compliant/Heel-proof.						

GRATES: STANDARD, DECORATIVE & METAL

Square Grates (continued)

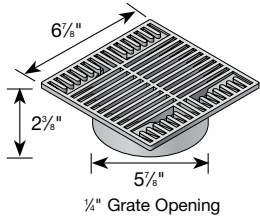

Part No.	Description	Color	Pkg. Qty.	Wt. Ea. lbs.	Product Class	Specifications
771	7" Square Grate	Black	10	0.65	10ND	7" Square Structural Foam Polyolefin Grate with UV inhibitor. Open surface area 13.60 square inches. 41.60 GPM.
772	7" Square Grate	Green	10	0.65	10ND	
 Fits Spee-D® Basin, 6" Sewer and Drain Pipe & Fittings, 6" Corrugated Pipe. (see page 79). ADA Compliant/Heel-proof.						

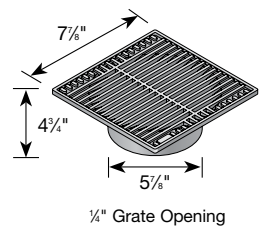

Part No.	Description	Color	Pkg. Qty.	Wt. Ea. lbs.	Product Class	Specifications
881	8" Square Grate	Black	10	0.79	10ND	8" Square Structural Foam Polyolefin Grate with UV inhibitor. Open surface area 17.16 square inches. 52.49 GPM.
882	8" Square Grate	Green	10	0.79	10ND	
 Fits Spee-D® Basin, 6" Sewer and Drain Pipe & Fittings, 6" Corrugated Pipe and DWV Pipe. (see page 79). ADA Compliant/Heel-proof.						

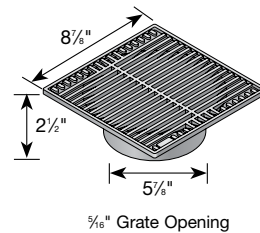

Part No.	Description	Color	Pkg. Qty.	Wt. Ea. lbs.	Product Class	Specifications
950	9" Square Grate	Green	10	1.11	10ND	9" Square Structural Foam Polyolefin Grate with UV inhibitor. Open surface area 28.40 square inches. 86.88 GPM.
970	9" Square Grate	Black	10	1.11	10ND	
 Fits Spee-D® Basin, 6" Sewer and Drain Pipe & Fittings, 6" Corrugated Pipe. (see page 79). ADA Compliant.						

GRATES: STANDARD, DECORATIVE & METAL

Duracast™ In-Line Grates

DRAINAGE

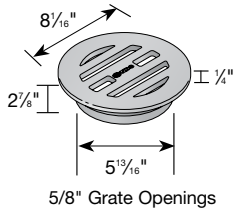

Part No.	Description	Color	Pkg. Qty.	Wt. Ea. (lbs.)	Product Class	Specifications
D6	6" Round Grate	Black*	1	7.30	10ND	6" Round Heavy-Duty Ductile Grate with Black Paint. Open surface area 7.05 square inches. 21.57 GPM. H-20 load rating.
 <p>Fits 6" Corrugated and Sewer and Drain Pipe. D6 is not a custom grate and qualifies for normal NDS freight terms. Fits SPEE-D® Basin. *Painted for shipping & display only; grate will form iron-oxide patina (see page 79).</p>						

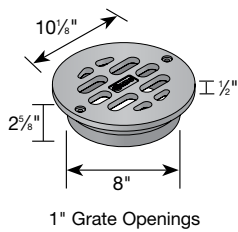

Part No.	Description	Color	Pkg. Qty.	Wt. Ea. (lbs.)	Product Class	Specifications
D8	8" Round Grate	Black*	1	14.59	10ND	8" Round Heavy-Duty Ductile Iron Grate with Black Paint. Open surface area 13.98 square inches. 42.77 GPM. Bolt holes for added security. H-20 load rating.
 <p>Fits 8" Corrugated and Sewer and Drain Pipe. D8 is not a custom grate and qualifies for normal NDS freight terms. *Painted for shipping & display only; grate will form iron-oxide patina (see page 79).</p>						

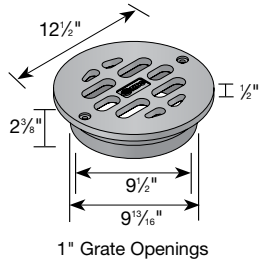

Part No.	Description	Color	Pkg. Qty.	Wt. Ea. (lbs.)	Product Class	Specifications
D10	10" Round Grate	Black*	1	20.60	10ND	10" Round Heavy-Duty Ductile Iron Grate with Black Paint. Open surface area 26.82 square inches. 82.05 GPM. Bolt holes for added security. H-20 load rating.
 <p>Fits 10" Corrugated and Sewer and Drain Pipe. D10 is not a custom grate and qualifies for normal NDS freight terms. *Painted for shipping & display only; grate will form iron-oxide patina (see page 79).</p>						

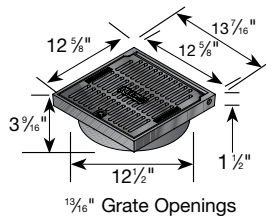

Part No.	Description	Color	Pkg. Qty.	Wt. Ea. (lbs.)	Product Class	Specifications
D12H-W0	12" Square Hinged Cast Iron Grate without Adapter	Black*	1	48.00	10ND	H-20 load rating. Open surface area 48.30 square inches. 147.76 GPM.
D12	12" Round Grate	Black*	1	16.00	10ND	H-20 load rating. Open surface area 55.16 square inches. 169.74 GPM.
 <p>Fits 12" Corrugated and Sewer and Drain Pipe. *Painted for shipping & display only; grate will form iron-oxide patina (see page 79).</p>						

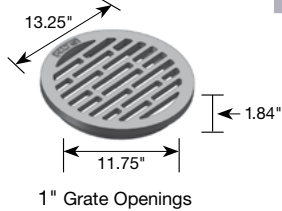

DRAINAGE PRODUCTS INDEX

Part No.	Page	Part No.	Page	Part No.	Page	Part No.	Page	Part No.	Page
1	48	201	26	907PC	40	1218GR	30, 42	9251	43
2	48	250	26	908PC	40	1218GY	30, 42	9252	43
3	48	252	44	909B	40	1218S	30, 42	9253	43
3C05	21, 38	252CI	44	910B	40	1220	31	9261	43
3C06	21, 38	252GY	44	913	28	1222	31	9262	43
3p02	38	252S	44	913B	41	1224	31, 42	9263	43
4	48	253	44	914PB	41	1224CI	31, 42	D6	50
4C06	21, 38	253CI	44	915	28	1224GR	31, 42	D8	50
4C07	21, 38	253GY	44	915SC	40	1224GY	31, 42	D10	50
4p02	38	253S	44	916	27	1224S	31, 42	D12	50
5	48	270	47	917SC	40	1225	29	D12H-WO	50
6	48	300	26	918B	40	1230	31	DS-601	44
6C06	21, 38	321	36	919PB	40	1230B	30, 41	DS-602	44
6C07	21, 38	350	26	920B	41	1240	46	DS-603	44
6P02	38	351	38	921B	41	1241	37	DS-604	44
06S	48	420	36	922PB	41	1242	35	DS-609	44
7	48	421	36	923PB	41	1243	35	DS-610-KIARO	44
8	48	430	37	930	28	1245	35	DS-611-VIA	44
9	48	451	38	930B	28, 41	1250	46	DS-612-VILLE	44
10	45	552B	40	930GRKIT	28	1260	46	EZ-0701A	21
11	45	553PB	40	931	28	1266	35	EZ-0701F	21
12	45	554	43	932	28	1280	30	EZ-1001A	21
13	45	554CI	43	950	49	1290	30	EZ-1001F	21
13P	45	554GY	43	970	49	1511	46	EZ-1501A	21
13S	45	554S	43	980	27	1512	46	EZ-1501F	21
14	45	555	43	981	27	1800	32	FWAS24CWH	25
15	45	555CI	43	990	27	1801SDG	46	FWAS24WH	25
16	45	555GY	43	991	27	1804	32	FWBP24	25
16P	45	555S	43	999	27	1810	32	FWFF67	25
16S	45	620	37	999S	27	1811	32	FWSD69	25
20	45	624	37	1040	46	1812	32	FWSPS3WH	25
30	45	625	37	1050	46	1813	32	SC-1820-C-0	23
30S	45	629	30, 31, 42, 43, 44	1060	46	1815	33	SC-1820-E-0	23
40	45	640	48	1060S	46	1816	32	SC-1820-M-0	23
50	45	641	48	1200	29	1830	33	SC-1820-S-0	23
60	45	642	48	1200BLKIT	29	1881	32	SC-2412P	23
60S	45	651	38	1200DSG	30	1882	32	SC-3020P	23
70	47	771	49	1200FF	29	1882BLKIT	32	SC-3475-C-0	23
72	47	772	49	1200GRKIT	29	1882GRKIT	32	SC-3475-E-0	23
74	47	829	44	1200KITDISP	29	1884	32	SC-3475-M-0	23
74S	47	839	30, 31, 42	1200GBKIT	29	1888	35	SC-3475-S-0	23
75	47	846	43	1203	29	1889	35	SC-44105-C-0	23
76	47	881	49	1204	29	1890	32	SC-44105-E-0	23
78	47	882	49	1206	35	1891	32	SC-44105-M-0	23
78B	41	900	27	1210	30	2400	34	SC-44105-S-0	23
78S	47	900-4	27	1211	30	2400BLKIT	34	SC-FL-10	23
80	47	900BLKIT	27	1212	30	2400GRKIT	34	SC-NWFF-500	23
81	47	900DSG	27	1212S	30	2404	34	SC-ST	23
90	47	900DSGKIT	27	1213	31	2410	34, 35	SC-WFF-75	23
90B	41	900FF	27	1215	31	2411	34		
90S	47	900GRKIT	27	1216	29	2412	34		
101	26	900KITDISP	27	1217	29	2413	34		
101GRKIT	26	905PB	40	1218	30, 42	2415	34		
101R	26	906PB	40	1218CI	30, 42	2418	34		





A photograph showing a close-up, low-angle view of a grey metal channel drain with a square grid pattern, installed in a concrete sidewalk. The drain runs parallel to a brick-paved area. In the background, blurred figures of people are walking, suggesting an outdoor public space.

CHANNEL & TRENCH DRAINS

CHANNEL AND TRENCH DRAINS

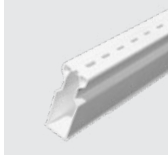
Channel & Trench Drain Product Line-up

NDS Channel and Trench Drain Systems provide durable and proven solutions for sheet-flow drainage in applications ranging from light foot traffic to heavy vehicular traffic.

PROFILE SERIES						
Micro Channel™	Slim Channel	Mini Channel™	Spee-D® Channel	Pro Series Channel™	Dura Slope™	BG-FILCOTEN®
						
Pools, Spas, Patios	Patios, Pools, Spas, Walkways & Paver Landscapes	Pools, Patios, Tennis Courts	Pools, Pool Decks, Driveways	3", 5", 8" and 12", Patios, Driveways, Sports Fields	Driveways, Parking Lots, Courtyards	4", 8" and 12", Fiber-reinforced Concrete

CHANNEL & TRENCH DRAINS

Durable

Designed for maximum durability, drainage, and performance NDS Channel and Trench Drains are a proven alternative to traditional concrete drains. UV inhibitors in the plastic grate, channel and component parts prevent fading and cracking from the sun. All plastic grate and channel components are **chemically resistant, rustproof, and maintenance-free**.

Simple

NDS Plastic Channel and Trench Drains are light weight and easy to install. Grates are removable for easy clean out and replacement. Grates may be held in place with screws or hold-down clips. A complete line of accessories is available for each Channel and Trench Drain System. Our "Profile Series" of channel drains connect like PVC pipe. Our modular "Pro Series" injection-molded channel has mechanical interlocking joints. Our "Dura Slope" Trench Drain System is injection-molded, modular, has mechanical interlocking joints and a built-in slope. All NDS Channel and Trench Drain Systems easily connect to sewer and drain pipes and fittings or Sch. 40 pipes and fittings.

Versatile

To blend with surrounding surfaces, our plastic Channel Grates are available in six colors, some with decoartive options, as well as solid brass for the Mini Channel. Cast iron and rolled steel grates are available for the Dura Slope and Pro Series Channel. A ductile iron frame is also available. NDS Channel and Trench Drains also offer a choice of outletting locations; bottom, end and side options available.

Efficient

Channel and Trench Drains eliminate the need for grading a deck surface to a low area. Instead, the deck is gradually sloped in one direction or plane, and the channel drain acts as a perimeter drain at the edge of the slope to receive sheet-flow runoff. Channel and Trench Drain Systems provide more overall open surface area than conventional area grates.











Recommended Applications

- Driveways
- Warehouses
- Washdown Areas
- Loading Docks
- Tennis Courts
- Patios
- Nurseries & Greenhouses
- Plazas
- Parking Lots
- Swimming Pools & Spas
- Running Tracks
- Courtyards
- Sidewalks
- Sports Facilities
- Manufacturing Facilites
- Landings

See capacity recommendations for channel & trench drains, pages 79 & 87.

CHANNEL AND TRENCH DRAINS

Application Matrix – Choosing the Right Product

Top Applications		Micro Channel™	Slim Channel	Mini Channel™	Spee-D® Channel	3" Pro Series Channel™	5" Pro Series Channel™	8" Pro Series Channel™	12" Pro Series Channel™	Dura Slope™	BG-FILCOTEN®
	Pool Decks & Patios	●	●	●	●	●	●	●	●	●	●
	Sidewalks & Walkways	●	●	●	●	●	●	●	●	●	●
	Plazas & Courtyards		●	●	●	●	●	●	●	●	●
	Residential Driveways			●	●	●	●	●	●	●	●
	Sports Facilities						●	●	●	●	●
	Factory Floors						●	●	●	●	●
	Loading Docks						●	●	●	●	●
	Washdown Areas						●	●	●	●	●
	Parking Lots						●	●	●	●	●
	Warehouses (hard-tire forklifts)									●	●

PROFILE CHANNEL DRAINS

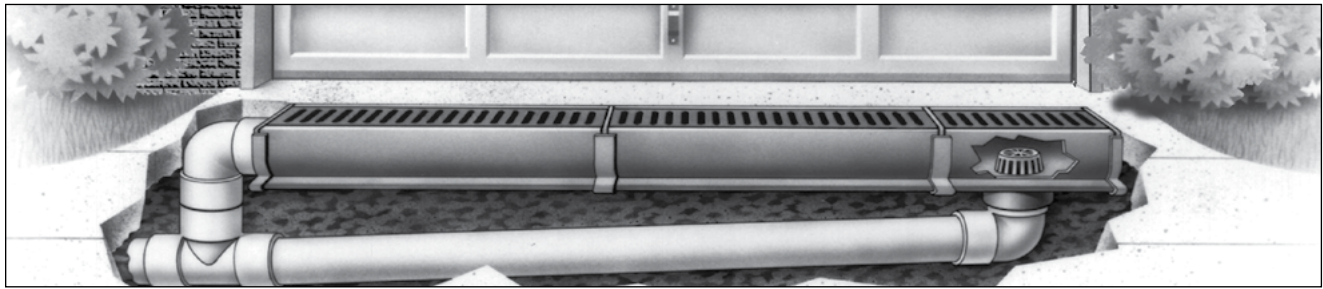

CHANNEL & TRENCH DRAINS

Details

Unique patented flying buttress design provides load-bearing support from both sides as well as underneath.

Available in three sizes: Spee-D® for driveways, large decks and commercial areas; Mini for landscapes, pools or decks; and Micro for residential pools and spas.

Unique flanges on the bottom of the channel provide an anchoring lip for straight installation and prevents floating.

Materials and Standards

- Only channels made of PVC can be cut to any length and solvent-welded like PVC pipe.
- rates available in six colors with decorative options – see individual products for details.
- Mini Channel Grate also available in solid brass.
- Channel system offers choice of bottom, end or side outlets.
- Concrete is not required under some channels for light vehicular applications. Standards vary per product.

Mini and Spee-D® Channel System Components

1. Channel
2. Grate
3. Coupling
4. End Cap or End Outlet
5. Channel Bottom Outlet
6. Sewer and Drain Fitting
7. Drain Pipe

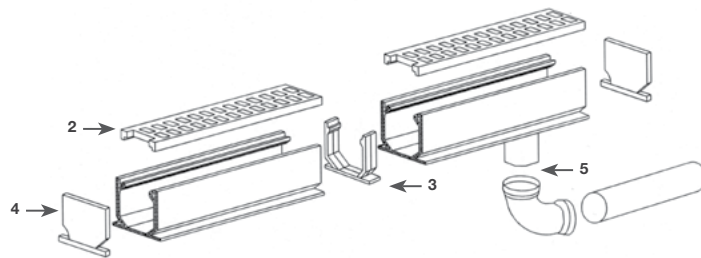

Slim Channel System Components

1. Robust extruded PVC channel available in 6-ft and 9-ft lengths
2. Anchor clips help secure the channel to a prepared base or suspend it with rebar
3. Attractive grate designs enhance any landscape and have high flow capacity for superior drainage
4. Couplers provide a secure channel-to-channel connection
5. End caps have a convenient KNOCKOUT for outletting to 1.5-in SCH 40 pipe
6. Convenient bottom outlets can be installed anywhere along the channel for 1.5-in SCH 40 pipe connections

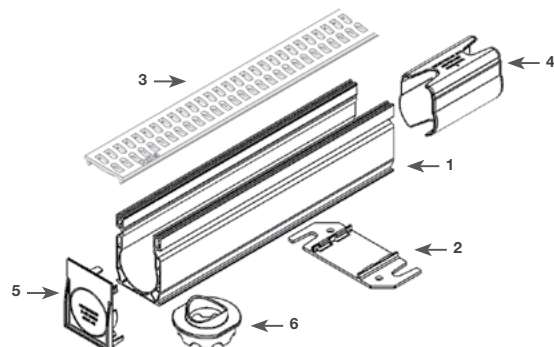

PROFILE CHANNEL DRAINS

Micro Channel™ Drains

Excellent performance at lowest possible cost. Designed for residential applications including swimming pools, spas and patios. Unique design features grate openings parallel to channel length and recessed grate for strength and effective runoff capture.

CHANNEL & TRENCH DRAINS

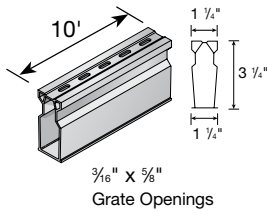

Part No.	Description	Color	Pkg. Qty.	Wt. Ea. (lbs.)	Product Class	Specifications
8001	10' Long Micro Channel	White	100 ft.	5.00	25PF	10 ft. Micro Channel with Recessed Reinforced Grate Area, Parallel Drain Slots with UV inhibitor. Open surface area 1.00 square inch per linear foot. 3.06 GPM per foot. PVC.
8002	10' Long Micro Channel	Sand	100 ft.	5.00	25PF	
8003	10' Long Micro Channel	Gray	100 ft.	5.00	25PF	
	Includes 1 coupling. (see page 79). ADA Compliant/Heel-proof.					

Micro Accessories

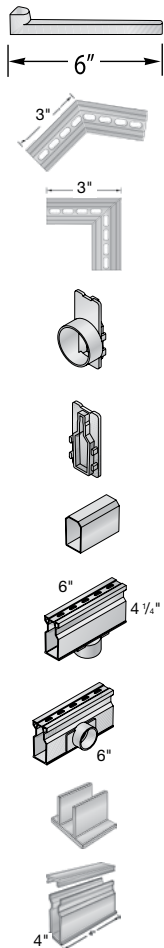



Part No.	Description	Color	Pkg. Qty.	Wt. Ea. (lbs.)	Product Class
230	6" Channel Installation Stake	Gray	24	0.04	25PF
8301	Micro Channel 45° Elbow	White	5	0.30	25PF
8302	Micro Channel 45° Elbow	Sand	5	0.30	25PF
8303	Micro Channel 45° Elbow	Gray	5	0.30	25PF
8381	Micro Channel 90° Elbow	White	5	0.40	25PF
8382	Micro Channel 90° Elbow	Sand	5	0.40	25PF
8383	Micro Channel 90° Elbow	Gray	5	0.40	25PF
8461	Micro 1 1/2" Sch. 40 Spigot End Outlet	White	10	0.10	25PF
8462	Micro 1 1/2" Sch. 40 Spigot End Outlet	Sand	10	0.10	25PF
8463	Micro 1 1/2" Sch. 40 Spigot End Outlet	Gray	10	0.10	25PF
8471	Micro End Plug	White	20	0.05	25PF
8472	Micro End Plug	Sand	20	0.05	25PF
8473	Micro End Plug	Gray	20	0.05	25PF
8481	Micro Channel Couplings only Fits inside channel	White	20	0.10	25PF
8501	Micro 1 1/2" Sch. 40 Spigot Bottom Outlet	White	10	0.35	25PF
8502	Micro 1 1/2" Sch. 40 Spigot Bottom Outlet	Sand	10	0.35	25PF
8503	Micro 1 1/2" Sch. 40 Spigot Bottom Outlet	Gray	10	0.35	25PF
8511	Micro 1 1/2" Sch. 40 Spigot Side Outlet	White	10	0.35	25PF
8512	Micro 1 1/2" Sch. 40 Spigot Side Outlet	Sand	10	0.35	25PF
8513	Micro 1 1/2" Sch. 40 Spigot Side Outlet	Gray	10	0.35	25PF
8601	Micro Hold-Down Clips Use with Channel Stakes to hold channel in place	White	20	0.10	25PF
8651	Micro Channel Cleanout	White	10	0.30	25PF
8652	Micro Channel Cleanout	Sand	10	0.30	25PF
8653	Micro Channel Cleanout	Gray	10	0.30	25PF

PROFILE CHANNEL DRAINS

Slim Channel Drains

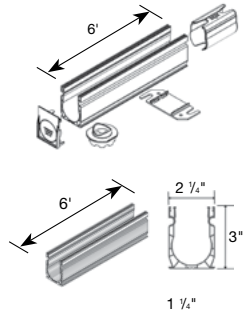
Excellent for light duty applications, including residential pools, concrete and paver patios, spas, walkways and paver landscapes.



Part No.	Description	Color	Pkg. Qty.	Wt. Ea. (lbs.)	Product Class	Specifications
9206SKIT	6 ft. Slim Channel Kits with sand plastic grates	Sand	15 EA (90 LF)	4.2	25PF	2.25" wide Channel Drain Kits & Assemblies
9206GKIT	6 ft. Slim Channel Kits with gray plastic grates	Gray	15 EA (90 LF)	4.2	25PF	
9209WHITE	9 ft. Slim Channel & Grate Assembly	White	10 EA (90 LF)	5.58	25PF	
9209SAND	9 ft. Slim Channel & Grate Assembly	Sand	10 EA (90 LF)	5.58	25PF	
9209GRAY	9 ft. Slim Channel & Grate Assembly	Gray	10 EA (90 LF)	5.58	25PF	PVC Channel with UV inhibitor
9206	6 ft. Slim Channel	Black	15 EA (90 LF)	3.00	25PF	See related specifications for 9241, 9242 & 9243 plastic slotted grates
9209	9 ft. Slim Channel	Black	10 EA (90 LF)	4.5	25PF	
	(see page 79).					

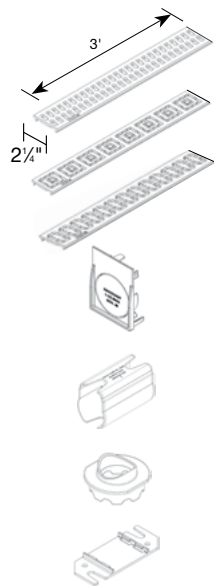

Part No.	Description	Color	Pkg. Qty.	Wt. Ea. (lbs.)	Product Class	Specifications
9241	3 ft. Slim Channel Grate	White	30 EA (90 LF)	0.36	25PF	3 ft polypropylene channel grate with UV inhibitor. Open Surface Area 7.01 square inches per foot. 21.44 GPM per foot.
9242	3 ft. Slim Channel Grate	Sand	30 EA (90 LF)	0.36	25PF	
9243	3 ft. Slim Channel Grate	Gray	30 EA (90 LF)	0.36	25PF	
9251	3 ft. Slim Channel Grate Square	White	30 EA (90 LF)	0.36	25PF	3 ft Polypropylene Decorative Square Channel Grate with UV inhibitor. Open Surface Area 5.73 square inches per foot. 21.44 GPM per foot.
9252	3 ft. Slim Channel Grate Square	Sand	30 EA (90 LF)	0.36	25PF	
9253	3 ft. Slim Channel Grate Square	Gray	30 EA (90 LF)	0.36	25PF	
9261	3 ft. Slim Channel Grate Chain	White	30 EA (90 LF)	0.36	25PF	3 ft Polypropylene Decorative Chain Channel Grate with UV inhibitor. Open Surface Area 5.73 square inches per foot. 21.44 GPM per foot.
9262	3 ft. Slim Channel Grate Chain	Sand	30 EA (90 LF)	0.36	25PF	
9263	3 ft. Slim Channel Grate Chain	Gray	30 EA (90 LF)	0.36	25PF	
	(see page 79).					

Part No.	Description	Color	Pkg. Qty.	Wt. Ea. (lbs.)	Product Class	Specifications
9247	Slim Channel End Cap/Outlet	Black	20 EA	0.04	25PF	End & bottom outlets fit 1-1/2" Schedule 40 pipe
9248	Slim Channel Coupling	Black	20 EA	0.08	25PF	
9250	Slim Channel Bottom Outlet	Black	10 EA	0.04	25PF	
9270	Slim Channel Anchor Clip	Black	20 EA	0.04	25PF	
9301	Slim Channel Fab 45	White	1 EA	0.29	25PF	
9302	Slim Channel Fab 45	Sand	1 EA	0.29	25PF	
9303	Slim Channel Fab 45	Gray	1 EA	0.29	25PF	
9371	Slim Channel Fab Tee	White	1 EA	0.41	25PF	
9372	Slim Channel Fab Tee	Sand	1 EA	0.41	25PF	
9373	Slim Channel Fab Tee	Gray	1 EA	0.41	25PF	
9381	Slim Channel Fab 90	White	1 EA	0.35	25PF	
9382	Slim Channel Fab 90	Sand	1 EA	0.35	25PF	
9383	Slim Channel Fab 90	Gray	1 EA	0.35	25PF	

CHANNEL & TRENCH DRAINS

PROFILE CHANNEL DRAINS

Mini Channel™ Drains

Excellent for light-duty applications including residential pools, concrete and paver patios, spas and tennis courts.

CHANNEL & TRENCH DRAINS

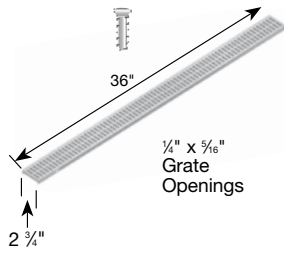

Part No.	Description	Color	Pkg. Qty.	Wt. Ea. (lbs.)	Product Class	Specifications
529	Stainless Steel Screws, FH #4 x 5/8"	Steel	64/Bag	0.10	25PF	3 ft. Structural Foam Polyolefin Channel Grate with UV inhibitor. Open surface area 9.90 square inches per foot. 30.29 GPM per foot.
540	3' Channel Grate	White	48 ft.	0.66	25PF	
541	3' Channel Grate	Gray	48 ft.	0.66	25PF	
542	3' Channel Grate	Green	48 ft.	0.66	25PF	
543	3' Channel Grate	Black	48 ft.	0.66	25PF	
544	3' Channel Grate	Sand	48 ft.	0.66	25PF	
551	3' Channel Grate	Brick Red	48 ft.	0.66	25PF	
Requires 4 screws per Grate. (see page 79). ADA Compliant/Heel-proof.						

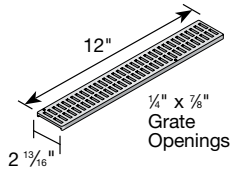

Part No.	Description	Color	Pkg. Qty.	Wt. Ea. (lbs.)	Product Class	Specifications
552B	1' Brass Channel Grate	Satin Brass	12	1.25	25PF	1 ft. Mini Channel Solid Brass Grate with brass screws. Open surface area 9.20 square inches per foot. 28.14 GPM per foot.
553PB	1' Brass Channel Grate	Polished Brass	12	1.25	25PF	
Fits #500 Mini Channel. (see page 79). ADA Compliant/Heel-proof.						

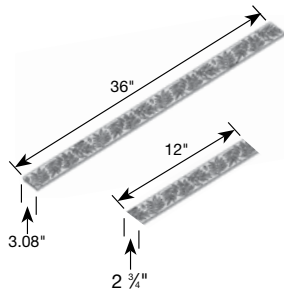

Part No.	Description	Color	Pkg. Qty.	Wt. Ea. (lbs.)	Product Class	Specifications
846	Stainless Steel Screws, FH #4 x 1"	Steel	40/Bag	0.10	25PF	3 ft. Structural Foam Polyolefin botanical pattern Channel Grate with UV inhibitor. Open surface area 5.44 square inches per foot. 16.64 GPM per foot.
554S	3' Botanical Channel Grate	Sand	16	0.89	25PF	
554GY	3' Botanical Channel Grate	Gray	16	0.89	25PF	
554	3' Botanical Channel Grate	Black	16	0.89	25PF	
554CI	1' Botanical Cast Iron Channel Grate	Black*	1	1.82	25PF	1 ft. Mini Channel botanical Cast Iron Channel Grate. Open surface area 5.39 square inches per foot. 16.49 GPM per foot. Class B load rated.
Fits #500 Mini Channel. (see page 79). ADA Compliant. *Painted for shipping & display only; grate will form iron-oxide patina						

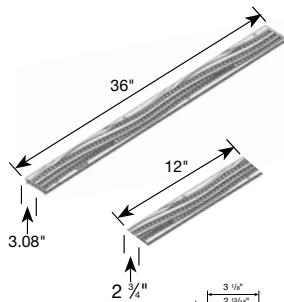

Part No.	Description	Color	Pkg. Qty.	Wt. Ea. (lbs.)	Product Class	Specifications
846	Stainless Steel Screws, FH #4 x 1"	Steel	40/Bag	0.10	25PF	3 ft. Structural Foam Polyolefin wave pattern Channel Grate with UV inhibitor. Open surface area 5.73 square inches per foot. 17.54 GPM per foot.
555S	3' Wave Channel Grate	Sand	16	0.88	25PF	
555GY	3' Wave Channel Grate	Gray	16	0.88	25PF	
555	3' Wave Channel Grate	Black	16	0.88	25PF	
555CI	1' Wave Cast Iron Channel Grate	Black*	1	1.30	25PF	1 ft. Mini Channel Wave Cast Iron Channel Grate. Open surface area 4.11 square inches per foot. 12.56 GPM per foot. Class B load rated.
Fits #500 Mini Channel. (see page 79). ADA Compliant. *Painted for shipping & display only; grate will form iron-oxide patina						

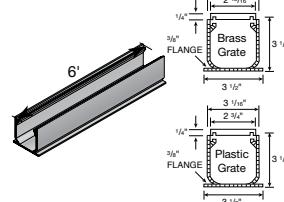

Part No.	Description	Color	Pkg. Qty.	Wt. Ea. (lbs.)	Product Class	Specifications
500	6' Mini Channel Drain	Gray	48 ft.	3.26	25PF	6 ft. PVC Mini Channel Drain with inverse flying-buttress design, bottom flange, patented honeycomb reinforced walls and UV inhibitor.
500S	6' Mini Channel Drain	Sand	48 ft.	3.26	25PF	
Grate should be recessed 1/8" below finish grade in non-traffic applications. Grate should be recessed 1/4" in traffic applications.						

PROFILE CHANNEL DRAINS

Mini Channel Accessories

Excellent for light duty applications, including residential pools, concrete and paver patios, spas and tennis courts.

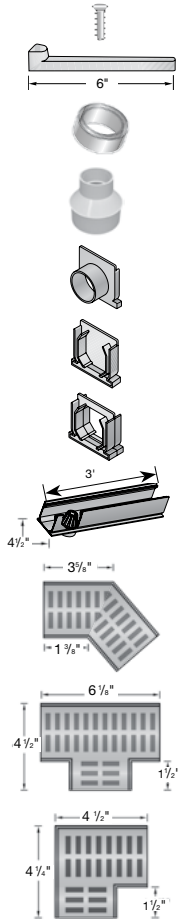

Part No.	Description	Color	Pkg. Qty.	Wt. Ea. (lbs.)	Product Class
529	Stainless Steel Screws, FH #4 x 5/8"	Steel	64/Bag	0.10	25PF
230	6" Channel Installation Stake	Gray	24	0.04	25PF
532	Adapter Bushing for Mini Channel 2" Bottom & End Outlet to 3" S&D Fittings	White	20	0.14	30PV
533	Adapter for Mini Channel 2" Bottom & End Outlet to 4" S&D Fittings	White	20	0.34	30PV
546	Mini Channel End Outlet to 2" Sch. 40 Pipe Fittings	Gray	10	0.15	25PF
546S	Mini Channel End Outlet to 2" Sch. 40 Pipe Fittings	Sand	10	0.15	25PF
547	Mini Channel End Cap	Gray	20	0.12	25PF
547S	Mini Channel End Cap	Sand	20	0.12	25PF
548	Mini Channel Coupling	Gray	20	0.12	25PF
548S	Mini Channel Coupling	Sand	20	0.12	25PF
550	3' Mini Channel Drain with Atrium Strainer and Bottom Outlet to 2" Sch. 40 Pipe Fittings	Gray	6	2.17	25PF
5300	Fabricated 45° Elbow with Grate	Gray	1	0.40	25PF
5303	Fabricated 45° Elbow with Grate	Sand	1	0.40	25PF
5370	Fabricated Tee with Grate	Gray	1	0.50	25PF
5380	Fabricated 90° Elbow with Grate	Gray	1	0.40	25PF
5383	Fabricated 90° Elbow with Grate	Sand	1	0.40	25PF

CHANNEL & TRENCH DRAINS

Profile Channel Paver Installation

NDS Profile Channel Systems and grates are dimensionally compatible with standard 2-3/8" clay and concrete paving systems. Both decorative and standard grate options make Profile Channel an ideal choice for drainage on paver pool decks, patios, plazas, courtyards and parking courts.



PROFILE CHANNEL DRAINS

Spee-D® Channel Drains

Ideal for commercial as well as residential applications. Effective in everything from patios to light vehicular traffic areas.

CHANNEL & TRENCH DRAINS

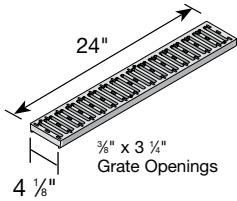

Part No.	Description	Color	Pkg. Qty.	Wt. Ea. (lbs.)	Product Class	Specifications	
229	Stainless Steel Screws, FH #8 X 1" for Spee-D Channel Plastic Slotted Grates	Steel	48/Bag	0.06	25PF	2 ft. Structural Foam Polyolefin Secured Channel Grate with UV inhibitor. Open surface area 16.76 square inches per foot. 51.27 GPM per foot.	
240	2' Channel Slotted Grate	White	24 ft.	1.33	25PF		
241	2' Channel Slotted Grate	Gray	24 ft.	1.33	25PF		
242	2' Channel Slotted Grate	Green	24 ft.	1.33	25PF		
243	2' Channel Slotted Grate	Black	24 ft.	1.33	25PF		
244	2' Channel Slotted Grate	Sand	24 ft.	1.33	25PF		
251	2' Channel Slotted Grate	Brick Red	24 ft.	1.42	25PF		
254	2' Galvanized Steel Channel Grate	Galvanized Steel	24 ft.	1.90	25PF		
	(see page 79). ADA Compliant.						

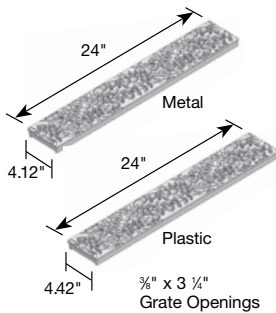

Part No.	Description	Color	Pkg. Qty.	Wt. Ea. (lbs.)	Product Class	Specifications	
829	Stainless Steel Screws, FH #6 X 1-1/4" for Spee-D Channel Decorative Plastic Grates	Steel	40/Bag	0.15	25PF	2 ft. Structural Foam Polyolefin decorative botanical Channel Grate with UV inhibitor. Open surface area 7.78 square inches per foot. 23.80 GPM per foot.	
252S	2' Channel Botanical Grate	Sand	24 ft.	1.74	25PF		
252GY	2' Channel Botanical Grate	Gray	24 ft.	1.74	25PF		
252	2' Channel Botanical Grate	Black	24 ft.	1.74	25PF		
252CI	2' Cast Iron Channel Botanical Grate	Black*	2 ft.	7.06	25PF		
229	Stainless Steel Screws, FH #8 X 1" for Spee-D Channel Decorative Iron Grates	Steel	48	0.06	25PF		
	(see page 79). ADA Compliant. *Painted for shipping & display only; grate will form iron-oxide patina						

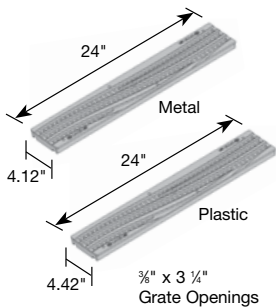

Part No.	Description	Color	Pkg. Qty.	Wt. Ea. (lbs.)	Product Class	Specifications	
829	Stainless Steel Screws, FH #6 X 1-1/4" for Spee-D Channel Decorative Plastic Grates	Steel	40/Bag	0.15	25PF	2 ft. Structural Foam Polyolefin decorative wave Channel Grate with UV inhibitor. Open surface area 7.78 square inches per foot. 23.80 GPM per foot.	
253S	2' Channel Wave Grate	Sand	24 ft.	1.84	25PF		
253GY	2' Channel Wave Grate	Gray	24 ft.	1.84	25PF		
253	2' Channel Wave Grate	Black	24 ft.	1.84	25PF		
253CI	2' Cast Iron Channel Wave Grate	Black*	2 ft.	7.52	25PF		
229	Stainless Steel Screws, FH #8 X 1" for Spee-D Channel Decorative Iron Grates	Steel	48	0.06	25PF		
	(see page 79). ADA Compliant. *Painted for shipping & display only; grate will form iron-oxide patina						

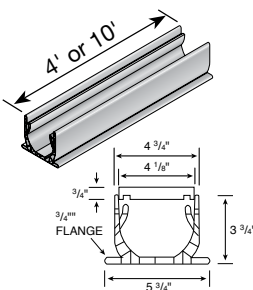

Part No.	Description	Color	Pkg. Qty.	Wt. Ea. (lbs.)	Product Class	Specifications
400	4' Spee-D Channel Drain	Gray	24 ft.	4.83	25PF	PVC Channel Drain with Inverse Flying Buttress design, bottom flange, patented honeycomb reinforced walls and UV inhibitor.
400-10	10' Spee-D Channel Drain	Gray	60 ft.	11.00	25PF	
400-10WH	10' Spee-D Channel Drain Assembly with pre-fastened Gray Plastic Grates	Gray	60 ft.	17.5	25PF	
400-10MTL	10' Spee-D Channel Drain Assembly with pre-fastened Galvanized Steel Grates	Galvanized Steel	40 ft.	20.5	25PF	
	Grate should be recessed 1/8" below finish grade in non-traffic applications. Grate should be recessed 1/4" below finished grade in traffic applications.					

PROFILE CHANNEL DRAINS

Spee-D® Accessories

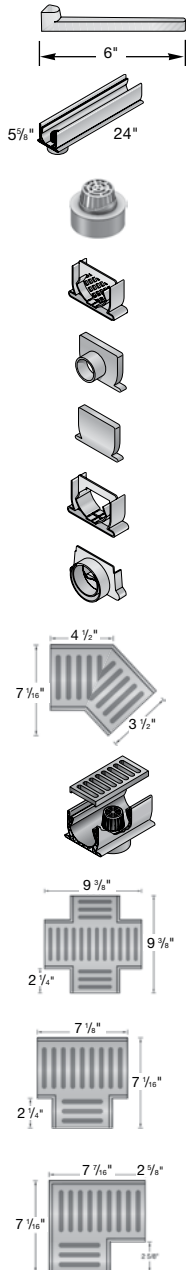

Part No.	Description	Color	Pkg. Qty.	Wt. Ea. (lbs.)	Product Class
230	6" Channel Installation Stake	Gray	24	0.04	25PF
234	2' Spee-D Channel Drain with Atrium Strainer and Bottom Outlet to 3" and 4" Sewer and Drain Fittings	Gray	12	2.67	25PF
2350	Spee-D Channel Bottom Outlet insert to 3" and 4" Sewer and Drain Fittings	Gray	5	0.30	25PF
245	Spee-D Channel Strainer Coupling	Gray	20	0.35	25PF
246	Spee-D Channel End Outlet to 2" Sch. 40 Pipe Fittings	Gray	10	0.40	25PF
247	Spee-D Channel End Cap	Gray	10	0.40	25PF
248	Spee-D Channel Coupling	Gray	20	0.40	25PF
249	Spee-D Channel Offset End Outlet to 3" Sewer and Drain Pipe and 4" Sewer and Drain Fittings	Gray	10	0.50	25PF
2301	Fabricated 45° Elbow with Grate	Gray	1	2.00	25PF
2351	7" Fabricated Grate 4" Bottom Outlet with Grate	Gray	1	1.70	25PF
2361	Fabricated Cross and Grate	Gray	1	3.00	25PF
2371	Fabricated Tee with Grate	Gray	1	3.00	25PF
2381	Fabricated 90° Elbow with Grate	Gray	1	3.00	25PF

PRO SERIES CHANNEL DRAINS



NDS Pro Series is a lightweight channel drain system with interlocking joints and a modular design, so systems are flexible and connections are made quickly and easily.

Load Rated: Up to NDS Class C with appropriate grate.
For Residential and Commercial applications.

The NDS Pro Series modular design offers flexibility as each section of channel can be snapped together for longer runs or divided down to lengths as short as 4" for smaller, interlocking sections.

Lightweight parts connect easily to sewer and drain pipe and fittings or Sch 40 pipe and fittings, and side and bottom outlets can be connected anywhere along the channel run.

- Channel-to-channel clips for reduced motion during installation
- Rebar clips instead of lower mount clips for an easier install
- Side ribs for increased strength
- Lay-flat design stabilizes channel during installation
- Thicker channel walls for additional strength

All this, and the channel still fits easily with all grates and end connectors.

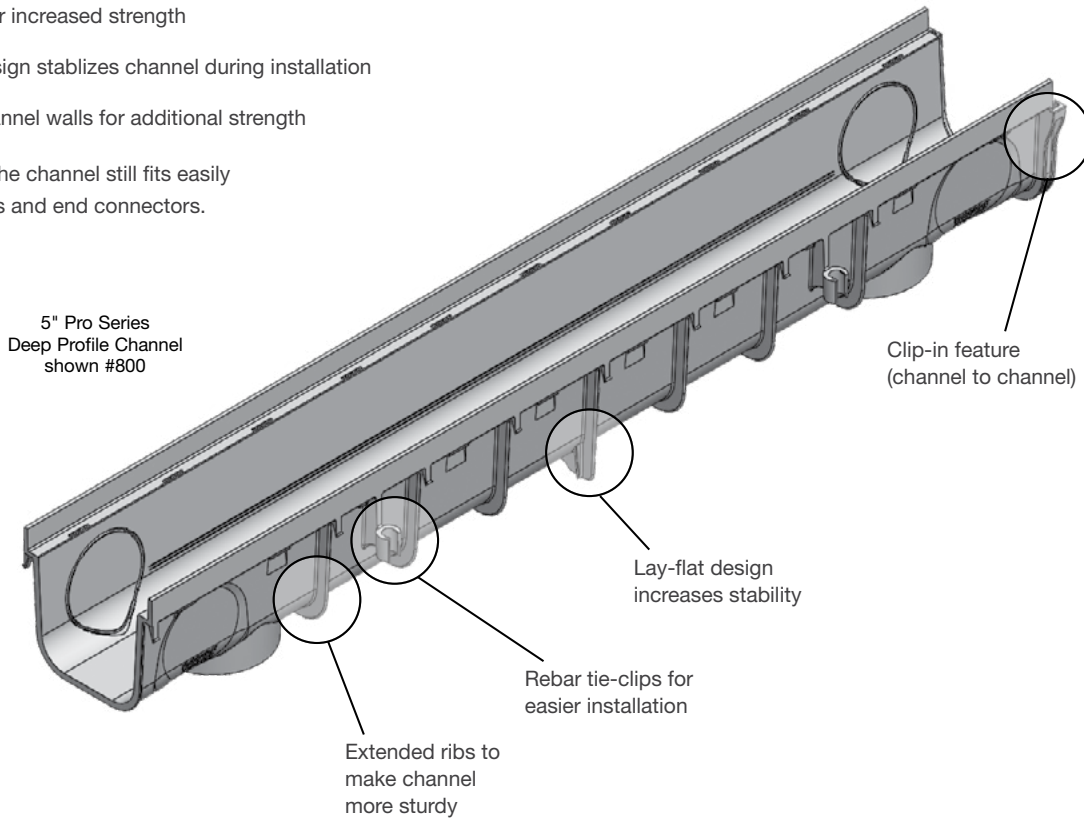

PRO SERIES CHANNEL DRAINS

Details

- Create a channel as long as you need, or reduce to lengths as short as 4" for smaller, interlocking sections.
- End cap/Knockout end and outlet fitting simplify assembly and installation.
- Flexible and easy: side and bottom outlets can be inserted at any location along the channel run.
- Available in four widths: 3", 5", 8" and 12"
- Available in two depths: deep for heavy flows, shallow for slabs or where little fall depth is available.
- Modular design comes in 1/2 meter (19 11/16") and 1 meter (39 3/8") pieces with interlocking end joints.
- Joints eliminate couplings and are specially designed to withstand concrete expansion and contraction.

Materials & Standards

- Polypropylene (3" & 5" channels) and polyvinyl chloride (8" & 12" channels) create a structurally-compact, water-tight channel.
- All parts contain UV inhibitors to prevent fading and cracking.

Load Recommendations

- Pedestrian Grates offer heel-proof pattern.
- Polyolefin Light Vehicular Grate for use in areas with passenger vehicles and light trucks with speeds less than 20 MPH.
- Load Star or Ductile Channel Grates for heavy-duty traffic.
- See individual products for details.

Pre-Assembled Channel Drain Systems

Our Modular Pro Series channel drains also come in pre-assembled kits to decrease installation time. They act as perimeter drains, quickly removing water from hardscapes and directing it away from building structures.

The 3" and 5" wide pre-assembled channel drain kits include a one-meter (39-3/8") channel drain and grate, end outlet, and end cap. A bottom outlet is built into each channel section. This allows for easy ordering and less inventorying, as everything is included under one part number.

Our unique Pro Series interlocking channel design allows each channel to securely lock to the next for a secure, tight fit, with no couplings required. The pre-assembled Pro Series channel drains are a great solution for your drainage needs.

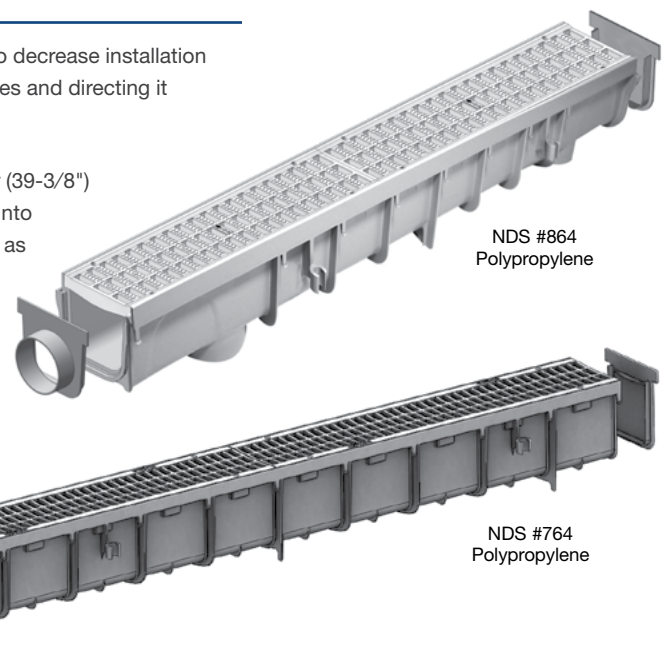
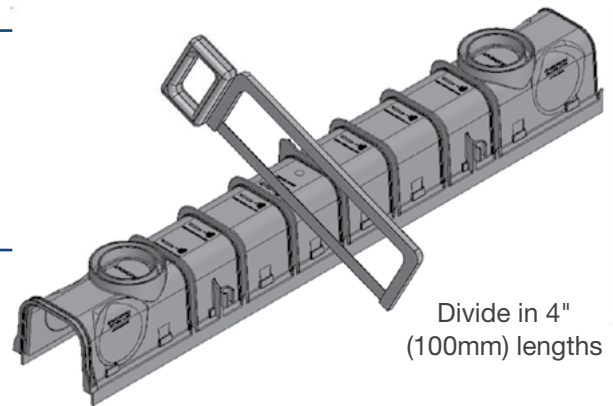

PRO SERIES CHANNEL DRAINS

CHANNEL & TRENCH DRAINS

3" Pro Series Channel™ Drains

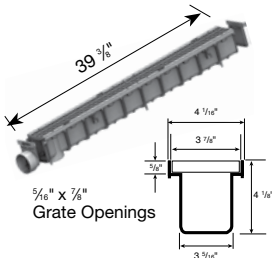

Part No.	Description	Color	Pkg. Qty.	Wt. Ea. (lbs.)	Product Class	Specifications
764	3" x 1 Meter Light Traffic Channel Grate & Channel Drain Kit	Light Gray	10	3.50	25IN	3" wide Light Traffic Channel Grate and Channel Drain with mechanical interlocking joints and UV inhibitors. Open surface area 23.63 square inches per foot. 76.85 GPM per foot.
	Includes 1 end outlet (#713) and 1 end cap (#712). Bottom and end outlets fit 3" S&D fittings. Grate should be recessed 1/8" below finish grade in non-traffic applications. Grate should be recessed 1/4" in traffic applications. (see page 79). ADA Compliant.					

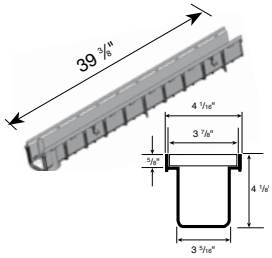

Part No.	Description	Color	Pkg. Qty.	Wt. Ea. (lbs.)	Product Class	Specifications
710	3" x 1 Meter Channel Drain*	Light Gray	12	1.90	25IN	3" wide Light Traffic Channel with mechanical interlocking joints and UV inhibitors. Polypropylene.
	Bottom outlet fits 3" S&D fittings. Grate should be recessed 1/8" below finish grade in non-traffic applications. Grate should be recessed 1/4" in traffic applications. *Produced under license of First Plast S.R.L.- Italy. (see page 79). ADA Compliant.					

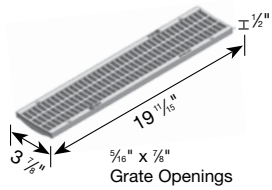

Part No.	Description	Color	Pkg. Qty.	Wt. Ea. (lbs.)	Product Class	Specifications
714	3" x 20" Light Traffic Channel Grate*	Light Gray	24	0.70	25IN	3" wide Light Traffic Channel Grate. Open surface area 23.63 square inches per foot. 72.29 GPM per foot. Polypropylene.
	Requires 4 #229 screws. *Produced under license of First Plast S.R.L.- Italy. (see page 79). ADA Compliant.					



Part No.	Description	Color	Pkg. Qty.	Wt. Ea. (lbs.)	Product Class	Specifications
713	3" End Cap/End Outlet	Light Gray	12	0.10	25IN	3" Channel End Cap/End Outlet. Polypropylene.
	Fits 3" Fittings.					

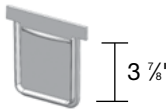

Part No.	Description	Color	Pkg. Qty.	Wt. Ea. (lbs.)	Product Class	Specifications
712	3" End Cap	Light Gray	20	0.05	25IN	3" Channel End Cap. Polypropylene.





Part No.	Description	Color	Pkg. Qty.	Wt. Ea. (lbs.)	Product Class	Specifications
229	Stainless Steel Screws FH H8 x 1"	Steel	48/Bag	0.06	25PF	

PRO SERIES CHANNEL DRAINS

5" Pro Series Channel™ Drains

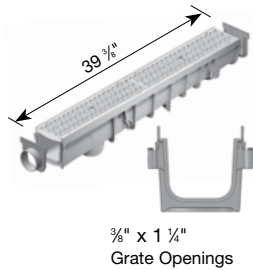
CHANNEL & TRENCH DRAINS



Part No.	Description	Color	Pkg. Qty.	Wt. Ea. (lbs.)	Product Class	Specifications
864	5" x 1 Meter Light Traffic Channel Kit with Light Gray Plastic Grates. Includes 1 End Outlet & 1 Cap	Light Gray	9	5.67	25IN	5" wide Light Traffic Channel Drain Kits and Displays.
864DISPLAY	5" Pro Series Channel Kit with Plastic Grate Display (9 kits)	Light Gray	1 box = 9 kits	51.03	25IN	See related specifications for 800 Channel and 814 & 824 Grates.
864GRTL	5" x 1 Meter Light Traffic Channel Kit with Galvanized Steel Grates. Includes 1 End Outlet & 1 Cap	Galvanized Steel	9	6.15	25IN	Includes channel, grates, screws, end cap and end cap/outlet.
864GRTLDISP	5" Pro Series Channel Kit with Steel Grate Display (9 kits)	Galvanized Steel	1 box = 9 kits	55.35	25IN	DISP includes 9 kits either light gray plastic or galvanized steel grates
	Grate should be recessed 1/8" below finish grade in non-traffic applications. Grate should be recessed 1/4" below finish grade in traffic applications. (see page 79). ADA Compliant.					

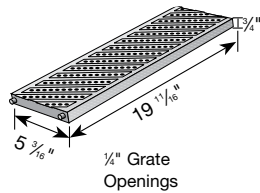

Part No.	Description	Color	Pkg. Qty.	Wt. Ea. (lbs.)	Product Class	Specifications
826	5" x 20" Pedestrian Traffic Channel Grate	Light Gray	10	1.00	25IN	5" wide UV-protected Structural Foam Polyolefin Pedestrian Traffic Channel Grate. Open surface area 4.86 square inches per foot. 24.26 GPM per foot.
	Requires #829 screws. (see page 79). ADA Compliant/Heelproof.					

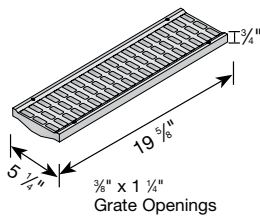

Part No.	Description	Color	Pkg. Qty.	Wt. Ea. (lbs.)	Product Class	Specifications
814	5" x 20" Light Traffic Channel Grate	Light Gray	10	1.16	25IN	5" wide Structural Foam Polyolefin Light Traffic Channel Grate with UV inhibitors. Open surface area 23.52 square inches per foot. 71.95 GPM per foot.
815	5" x 20" Light Traffic Channel Grate	Green	10	1.16	25IN	
816	5" x 20" Light Traffic Channel Grate	Black	10	1.16	25IN	
817	5" x 20" Light Traffic Channel Grate	Sand	10	1.16	25IN	
818	5" x 20" Light Traffic Channel Grate	Brick Red	10	1.16	25IN	
819	5" x 20" Light Traffic Channel Grate	White	10	1.16	25IN	
824	5" x 20" Galvanized Steel Light Traffic Channel Grate	Galvanized Steel	10	1.14	25IN	2 ft. Galvanized Steel Channel Grate. Open surface area 19.32 square inches per foot. 59.1 GPM per foot.
	Requires #829 screws. (see page 79). ADA Compliant.					

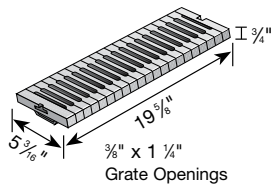

Part No.	Description	Color	Pkg. Qty.	Wt. Ea. (lbs.)	Product Class	Specifications
828	5" x 20" Load Star Heavy Traffic Channel Grate	Gray	10	2.35	25IN	5" wide UV-protected high-impact glass-reinforced nylon Heavy Traffic Channel Grate. Open surface area 15.92 square inches per foot. 48.70 GPM per foot.
	Requires 4 screws per grate. Requires #829 screws. (see page 79)					

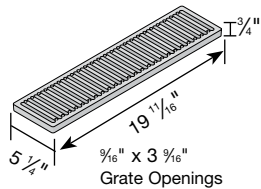

Part No.	Description	Color	Pkg. Qty.	Wt. Ea. (lbs.)	Product Class	Specifications
823	5" x 20" Ductile Channel Grate	Black*	1	12.30	25IN	5" wide heavy-duty Ductile Heavy Traffic Channel Grate. Open surface area 22.90 square inches per foot. 70.05 GPM per foot.
	Requires #829 screws. (see page 79). ADA Compliant. *Painted for shipping & display only; grate will form iron-oxide patina					



Part No.	Description	Color	Pkg. Qty.	Wt. Ea. (lbs.)	Product Class	Specifications
829	Stainless Steel Screws FH #6 x 1 1/4"	Steel	40/Bag	0.15	25PF	

PRO SERIES CHANNEL DRAINS

5" Pro Series Channel™ Drains (continued)

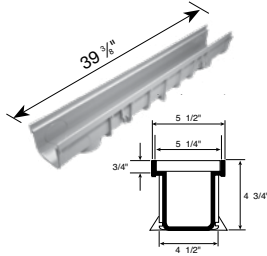

Part No.	Description	Color	Pkg. Qty.	Wt. Ea. (lbs.)	Product Class	Specifications
800	5" x 1 Meter Deep Profile Channel Drain	Light Gray	10	4.00	25IN	5" wide Deep Profile Channel Drain with interlocking joints, side rebar clips, integrated side and bottom outlet Knockouts. Polypropylene.
	New Integrated side outlet Knockouts fit 3" S&D pipe Integrated Knockout bottom outlet fits 3" and 4" S&D fittings. Grate should be recessed 1/8" below finish grade in non-traffic applications. Grate should be recessed 1/4" in traffic applications.					

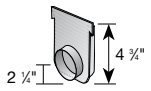

Part No.	Description	Color	Pkg. Qty.	Wt. Ea. (lbs.)	Product Class	Specifications
812	5" Deep Profile End Cap	Light Gray	10	0.13	25IN	5" wide Deep Profile End Cap. PVC.

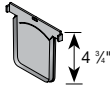

813	5" Deep Profile End Cap/3" S&D Hub & 4" S&D SPT Knockout End Outlet	Light Gray	10	0.40	25IN	5" wide Deep Profile End Cap/End Outlet. PVC.
-----	---	------------	----	------	------	---

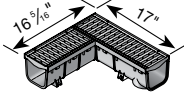

861	5" Deep Profile Grate & Channel Drain 90° Elbow	Light Gray	1	3.44	25IN	
-----	---	------------	---	------	------	--

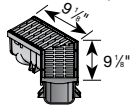

862	5" Deep Profile Grate & Channel Drain 45° Elbow	Light Gray	1	3.44	25IN	
-----	---	------------	---	------	------	--

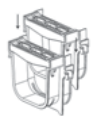

PSRC-864	Quik-Turn™ 5" Deep Radius Coupling Provides a 6 degree bend left or right	Light Gray	9	0.30	25IN	
----------	---	------------	---	------	------	--

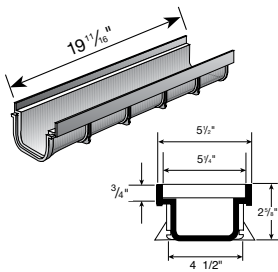

Part No.	Description	Color	Pkg. Qty.	Wt. Ea. (lbs.)	Product Class	Specifications
820	5" x 20" Shallow Profile Channel Drain*	Light Gray	10	1.35	25IN	5" wide Shallow Profile UV-protected high-impact PVC Channel Drain with mechanical interlocking joint.
	Grate should be recessed 1/8" below finish grade in non-traffic applications. Grate should be recessed 1/4" in traffic applications. *Produced under license of First Plast S.R.L. - Italy.					

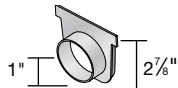

Part No.	Description	Color	Pkg. Qty.	Wt. Ea. (lbs.)	Product Class	Specifications
821	5" Shallow Profile End Cap/1-1/2" Sch. 40 SPT Knockout End Outlet*	Light Gray	10	0.15	25IN	5" wide Shallow Profile high-impact PVC End Cap/End Outlet.
	End Outlet fits 1-1/2" Schedule 40 fittings. *Produced under license of First Plast S.R.L. - Italy.					

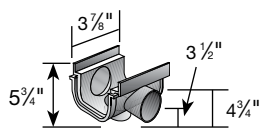

Part No.	Description	Color	Pkg. Qty.	Wt. Ea. (lbs.)	Product Class	Specifications
822	5" Shallow Profile 3" S&D SPT Bottom Outlet/1 1/2" Sch. 40 Hub Side Outlet	Light Gray	10	0.60	25IN	5" wide Shallow Profile high-impact PVC Bottom/Side Outlet.
	Side Outlets fit 1-1/2" Schedule 40 pipe Bottom Outlet fits 3" S&D fittings					

PRO SERIES CHANNEL DRAINS

8" Pro Series Channel™ Drains

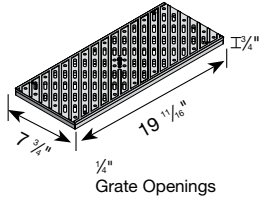

Part No.	Description	Color	Pkg. Qty.	Wt. Ea. (lbs.)	Product Class	Specifications
836	8" x 20" Pedestrian Traffic Channel Grate	Light Gray	1	1.55	25IN	8" wide UV-protected Structural Foam Polyolefin Pedestrian Traffic Channel Grate. Open surface area 13.82 square inches per foot. 42.28 GPM per foot.
	Requires #829 screws. 4 screws per grate. (see page 79). ADA Compliant/Heelproof.					

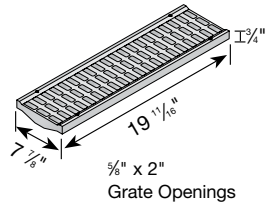

Part No.	Description	Color	Pkg. Qty.	Wt. Ea. (lbs.)	Product Class	Specifications
837	8" x 20" Light Traffic Channel Grate	Light Gray	1	3.00	25IN	8" wide UV-protected Structural Foam Polyolefin Light Traffic Channel Grate. Open surface area 30.28 square inches per foot. 92.63 GPM per foot.
	Requires #829 screws. 4 screws per grate. (see page 79)					

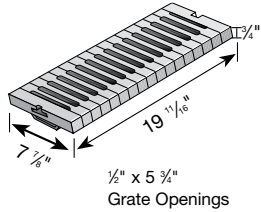

Part No.	Description	Color	Pkg. Qty.	Wt. Ea. (lbs.)	Product Class	Specifications
838	8" x 20" Load Star Heavy Traffic Channel Grate*	Light Gray	1	3.59	25IN	8" wide UV-protected high-impact glass-reinforced nylon Heavy Traffic Channel Grate. Open surface area 30.85 square inches per foot. 94.37 GPM per foot.
	Requires #829 screws. 4 screws per grate. *Produced under license of First Plast S.R.L. - Italy. (see page 79). ADA Compliant.					

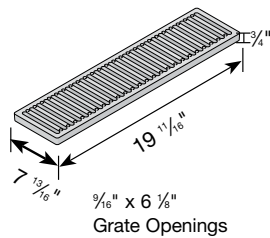

Part No.	Description	Color	Pkg. Qty.	Wt. Ea. (lbs.)	Product Class	Specifications
888	8" x 20" Ductile Channel Grate	Black*	1	22.24	25IN	8" wide heavy-duty Ductile Heavy Traffic Channel Grate. Open surface area 23.80 square inches per foot. 71.28 GPM per foot.
	*Painted for shipping & display only; grate will form iron-oxide patina #829 screws may be used. 4 screws per grate. (see page 79)					



Part No.	Description	Color	Pkg. Qty.	Wt. Ea. (lbs.)	Product Class	Specifications
829	Stainless Steel Screws FH #6 x 1 1/4"	Steel	40/Bag	0.15	25PF	

PRO SERIES CHANNEL DRAINS

8" Pro Series Channel™ Drains (continued)

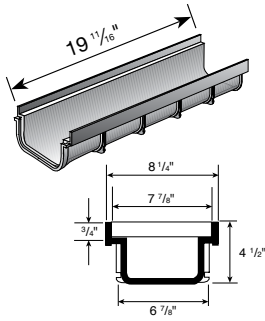

Part No.	Description	Color	Pkg. Qty.	Wt. Ea. (lbs.)	Product Class	Specifications
830	8" x 20" Shallow Profile Channel Drain*	Light Gray	1	2.00	25IN	8" wide Shallow Profile high-impact PVC Channel Drain with mechanical interlocking joints and UV inhibitors.
Grate should be recessed 1/8" below finish grade in non-traffic applications. Grate should be recessed 1/4" in traffic applications. *Produced under license of First Plast S.R.L. - Italy.						

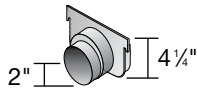

Part No.	Description	Color	Pkg. Qty.	Wt. Ea. (lbs.)	Product Class	Specifications
831	8" Shallow Profile End Cap/ 3" S&D SPT Knockout End Outlet*	Light Gray	1	0.49	25IN	8" wide Shallow Profile high-impact PVC End Cap/ End Outlet.
End Outlet fits 3" Sewer and Drain fittings *Produced under license of First Plast S.R.L. - Italy.						

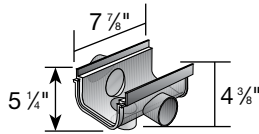

Part No.	Description	Color	Pkg. Qty.	Wt. Ea. (lbs.)	Product Class	Specifications
832	8" Shallow Profile 3" S&D SPT Side Outlet*	Light Gray	1	1.38	25IN	8" wide Shallow Profile high-impact PVC Bottom/Side Outlets with bottom adapter.
Bottom outlet fits 4" S&D pipe, side outlets fit 3" Sewer and Drain fittings. *Produced under license of First Plast S.R.L. - Italy.						

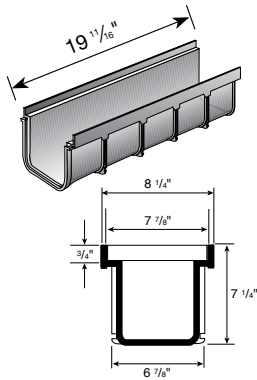

Part No.	Description	Color	Pkg. Qty.	Wt. Ea. (lbs.)	Product Class	Specifications
833	8" x 20" Deep Profile Channel Drain	Light Gray	1	2.80	25IN	8" wide Deep Profile high-impact PVC Channel Drain with mechanical interlocking joints and UV inhibitors.
Grate should be recessed 1/8" below finish grade in non-traffic applications. Grate should be recessed 1/4" in traffic applications.						

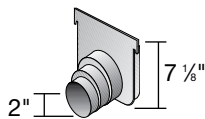

Part No.	Description	Color	Pkg. Qty.	Wt. Ea. (lbs.)	Product Class	Specifications
834	8" Deep Profile End Cap/3" & 4" S&D SPT Knockout End Outlet	Light Gray	10	0.51	25IN	8" wide Deep Profile high-impact PVC End Cap/End Outlet.
End Outlet fits 3" and 4" Sewer and Drain fittings *Produced under license of First Plast S.R.L. - Italy.						

PRO SERIES CHANNEL DRAINS

12" Pro Series Channel™ Drains

CHANNEL & TRENCH DRAINS

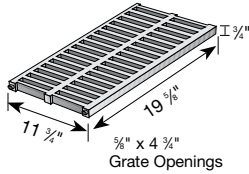

Part No.	Description	Color	Pkg. Qty.	Wt. Ea. (lbs.)	Product Class	Specifications
847	12" x 20" Light Traffic Channel Grate*	Gray	1	4.64	25IN	12" wide UV-protected high-impact PVC Light Traffic Channel Grate. Open surface area 48.77 square inches/foot. 149.19 GPM per foot.
	*Produced under license of First Plast S.R.L.- Italy. (see page 79)					

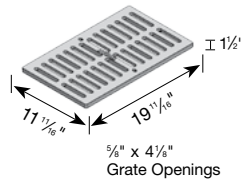

Part No.	Description	Color	Pkg. Qty.	Wt. Ea. (lbs.)	Product Class	Specifications
885	12" x 20" Ductile Iron Heavy Traffic Channel Grate	Black*	1	29.30	25IN	12" Wide Cast Iron Heavy Traffic Channel Grate. Open surface area 46.70 square inches per foot. 142.86 GPM per foot.
	*Painted for shipping & display only; grate will form iron-oxide patina (see page 79)					

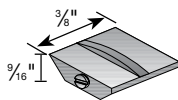

Part No.	Description	Color	Pkg. Qty.	Wt. Ea. (lbs.)	Product Class	Specifications
849	Grate Security Clip*	Gray	10	0.40	25IN	
	For use with 847 and 885 grates and 840 or 843 channels only (2 per grate). Mounts inside channel drain and secures grate. Screw and nut included. *Produced under license of First Plast S.R.L.- Italy.					

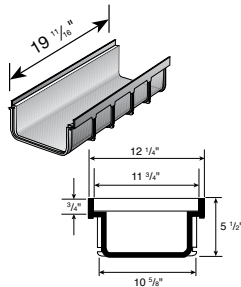

Part No.	Description	Color	Pkg. Qty.	Wt. Ea. (lbs.)	Product Class	Specifications
840	12" x 20" Shallow Profile Channel Drain	Light Gray	1	4.00	25IN	12" wide Shallow Profile UV-protected high-impact PVC Channel Drain with mechanical interlocking joints.
	Grate should be recessed 1/8" below finish grade in non-traffic applications. Grate should be recessed 1/4" in traffic applications.					

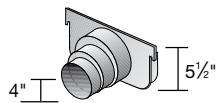

Part No.	Description	Color	Pkg. Qty.	Wt. Ea. (lbs.)	Product Class	Specifications
841	12" Shallow Profile End Cap/End Outlet Knockout with 4" S&D Hub* Fits 4" Sewer and Drain pipe	Light Gray	1	1.00	25IN	12" wide Shallow Profile high-impact PVC End Cap/Outlet with adapter.
	*Produced under license of First Plast S.R.L.- Italy.					

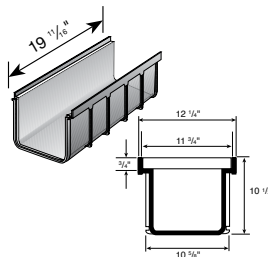

Part No.	Description	Color	Pkg. Qty.	Wt. Ea. (lbs.)	Product Class	Specifications
843	12" x 20" Deep Profile Channel Drain*	Light Gray	1	6.00	25IN	12" wide Deep Profile UV-protected high-impact PVC Channel Drain with mechanical interlocking joints.
	Grate should be recessed 1/8" below finish grade in non-traffic applications. Grate should be recessed 1/4" in traffic applications. *Produced under license of First Plast S.R.L.- Italy.					

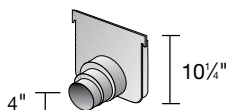

Part No.	Description	Color	Pkg. Qty.	Wt. Ea. (lbs.)	Product Class	Specifications
844	12" Deep Profile End Cap/End Outlet Knockout with 4" S&D Hub* Fits 4" Sewer and Drain pipe	Light Gray	1	1.60	25IN	12" wide Deep Profile high-impact PVC End Cap/Outlet with adapter.
	*Produced under license of First Plast S.R.L.- Italy.					

DURA SLOPE™ TRENCH DRAIN – PRE-SLOPED (PATENTED)



NDS Dura Slope™ is a high-quality quality, dependable, best-in-class trench drain system ideal for a variety of drainage solutions, including driveways, parking areas, warehouses, loading docks, pools, wash down areas and other areas for the interception and collection of surface runoff. Dura Slope™ pre-sloped and neutral trench drain system provides a solution for residential, commercial, industrial and municipal drainage needs.

The NDS Dura Slope™ trench drain system consists of 33 channel sections; 24 pre-sloped sections with 0.7% built in slope and 9 neutral sections. The system also has a catch basin assembly. All Dura Slope™ channel sections are 48" long, grip #3 and #4 rebar and support 6" wide grates. Dura Slope™ channel sections are also available in depths from 4" to 12".

The sloped channel sections enable the Dura Slope™ system to extend to a length of 96 feet with continuous slope. The neutral channel sections can be used for non-sloped system runs or can be used in conjunction with the pre-sloped channel sections for an extended system run of 132 feet. By incorporating central collection using the catch basin assembly, the Dura Slope™ trench drain system can be extended up to 266 feet. The ProFit™ locking system maintains structural integrity during installation, and is a locking device and support for the grates. Each channel section ships with ProFit™, Blank Grate Inserts and grate screws installed.

Details

- Lightweight 4 ft. modular sections
- Easier handling and installation
- Lower freight costs
- 2" radius bottom minimizes debris build-up
- Polyethylene material
- Durable and inexpensive
- Less breakage versus concrete
- High chemical resistance
- Bottom outlet on each channel section
- System versatility
- Requires fewer accessories
- 0.7% built-in slope
- Maintains optimum flow rates throughout system

DURA SLOPE™ TRENCH DRAIN – PRE-SLOPED (PATENTED)

Product Features & Benefits

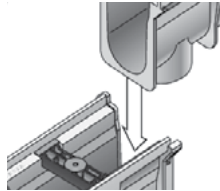

Interlocking tongue and groove joints

- Secures alignment
- Ensures straight channel runs
- Easy assembly and installation

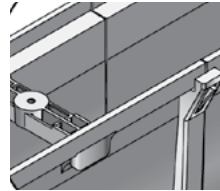

DuraLoc™ integral joint lock

- Prevents joint movement during installation
- No extra clamps or screws needed

Various grating options

- ADA compliant, Heel-Proof options
- Plastic grates
Array of colors
Pedestrian and light traffic rated
- Galvanized & stainless steel
Pedestrian & heavy traffic rated
- Cast & ductile iron
Class D heavy traffic rated (with frame)
- Decorative grates (ductile iron)
Standard black electrostatic coating
or raw iron Class C traffic rated

Lightweight 4 ft. modular sections

- Easier handling and installation
- Lower freight costs

Blank grate insert

- Eliminates use of plywood
- Slides for overlapping of channel sections
- Includes grates screws

Smooth HDPE interior

Virtually no water absorption

HDPE material

- Durable
- Inexpensive
- Less breakage versus concrete
- Chemical resistance

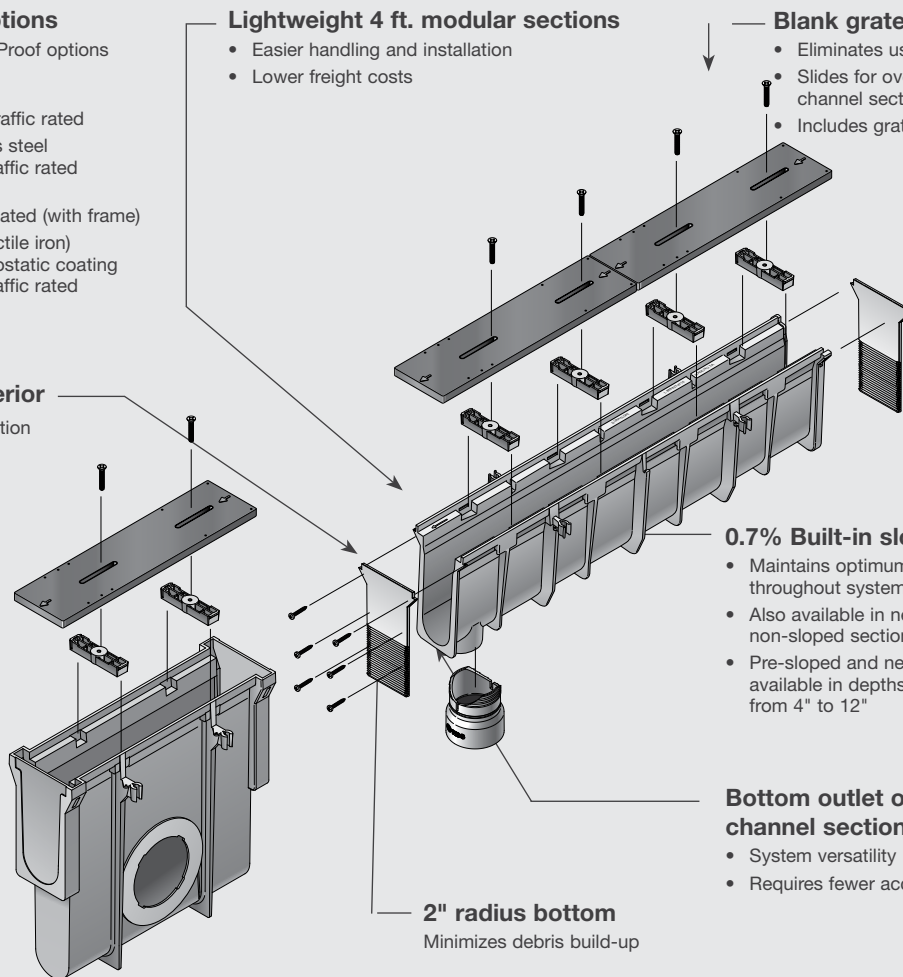

0.7% Built-in slope

- Maintains optimum flow rates throughout system
- Also available in neutrals; non-sloped sections
- Pre-sloped and neutrals available in depths from 4" to 12"

Bottom outlet on each channel section

- System versatility
- Requires fewer accessories

2" radius bottom

Minimizes debris build-up

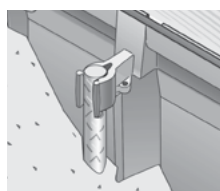

LevelLoc™ re-bar supports with integral protruding knob

- Levels channel and grips re-bar
- Requires fewer accessories

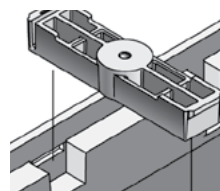

ProFit™ locking system

- Locks grate to integral frame
- Supports product in shipping and installation (included)

DURA SLOPE™ TRENCH DRAIN – PRE-SLOPED

Dura Slope™ Channel Drain Sections

CHANNEL & TRENCH DRAINS

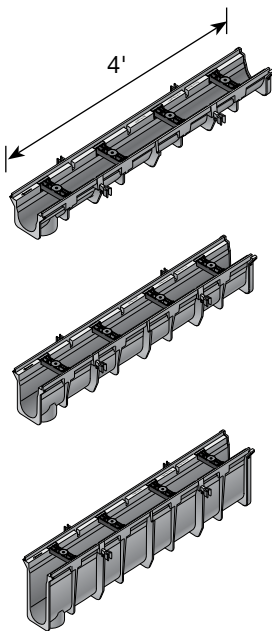



Part No.	Description	Color	Pkg. Qty.	Wt. Ea. (lbs.)	Product Class
DS-090N	3.99" Deep Neutral Dura Slope Channel	Light Gray	1	7.45	25DS
DS-091	3.99" to 4.34" Deep Dura Slope Channel	Light Gray	1	7.52	25DS
DS-091N	4.34" Deep Neutral Dura Slope Channel	Light Gray	1	7.81	25DS
DS-092	4.34" to 4.67" Deep Dura Slope Channel	Light Gray	1	7.92	25DS
DS-093	4.67" to 5.00" Deep Dura Slope Channel	Light Gray	1	8.27	25DS
DS-094	5.00" to 5.34" Deep Dura Slope Channel	Light Gray	1	8.64	25DS
DS-094N	5.34" Deep Neutral Dura Slope Channel	Light Gray	1	8.93	25DS
DS-095	5.34" to 5.68" Deep Dura Slope Channel	Light Gray	1	8.99	25DS
DS-096	5.68" to 6.01" Deep Dura Slope Channel	Light Gray	1	9.36	25DS
DS-097	6.01" to 6.35" Deep Dura Slope Channel	Light Gray	1	9.74	25DS
DS-097N	6.35" Deep Neutral Dura Slope Channel	Light Gray	1	10.04	25DS
DS-098	6.35" to 6.69" Deep Dura Slope Channel	Light Gray	1	10.11	25DS
DS-099	6.69" to 7.02" Deep Dura Slope Channel	Light Gray	1	10.48	25DS
DS-100	7.02" to 7.36" Deep Dura Slope Channel	Light Gray	1	10.86	25DS
DS-100N	7.36" Deep Neutral Dura Slope Channel	Light Gray	1	11.16	25DS
DS-101	7.36" to 7.69" Deep Dura Slope Channel	Light Gray	1	11.23	25DS
DS-102	7.69" to 8.03" Deep Dura Slope Channel	Light Gray	1	11.60	25DS
DS-103	8.03" to 8.37" Deep Dura Slope Channel	Light Gray	1	11.98	25DS
DS-103N	8.37" Deep Neutral Dura Slope Channel	Light Gray	1	12.27	25DS
DS-104	8.37" to 8.70" Deep Dura Slope Channel	Light Gray	1	12.34	25DS
DS-105	8.70" to 9.04" Deep Dura Slope Channel	Light Gray	1	12.71	25DS
DS-106	9.04" to 9.37" Deep Dura Slope Channel	Light Gray	1	13.07	25DS
DS-106N	9.37" Deep Neutral Dura Slope Channel	Light Gray	1	13.39	25DS
DS-107	9.37" to 9.70" Deep Dura Slope Channel	Light Gray	1	13.40	25DS
DS-108	9.70" to 10.05" Deep Dura Slope Channel	Light Gray	1	13.83	25DS
DS-109	10.05" to 10.38" Deep Dura Slope Channel	Light Gray	1	14.20	25DS
DS-109N	10.38" Deep Neutral Dura Slope Channel	Light Gray	1	14.50	25DS
DS-110	10.38" to 10.71" Deep Dura Slope Channel	Light Gray	1	14.57	25DS
DS-111	10.71" to 11.05" Deep Dura Slope Channel	Light Gray	1	14.95	25DS
DS-112	11.05" to 11.39" Deep Dura Slope Channel	Light Gray	1	15.32	25DS
DS-112N	11.39" Deep Neutral Dura Slope Channel	Light Gray	1	15.60	25DS
DS-113	11.39" to 11.72" Deep Dura Slope Channel	Light Gray	1	15.69	25DS
DS-114	11.72" to 12.06" Deep Dura Slope Channel	Light Gray	1	16.06	25DS

DURA SLOPE™ TRENCH DRAIN – PRE-SLOPED

Standard Grates

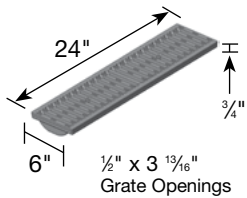
CHANNEL & TRENCH DRAINS



Part No.	Description	Color	Pkg. Qty.	Wt. Ea. (lbs.)	Product Class	Specifications
660	2 ft. Channel Grate	White	1	2.82	25DS	2 ft. Structural Foam Polyolefin, secured Channel Grate with UV inhibitor. Open surface area 25.40 square inches per foot. 77.70 GPM per foot.
661	2 ft. Channel Grate	Dark Gray	1	2.82	25DS	
661LG	2 ft. Channel Grate	Light Gray	1	2.82	25DS	
662	2 ft. Channel Grate	Green	1	2.82	25DS	
663	2 ft. Channel Grate	Black	1	2.82	25DS	
664	2 ft. Channel Grate	Sand	1	2.82	25DS	
665	2 ft. Channel Grate	Brick Red	1	2.82	25DS	
 Use with Dura Slope Drains (page 72), Dura Slope Catch Basins (page 74). (see page 79). ADA Compliant.						

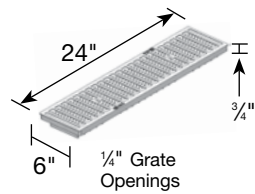

Part No.	Description	Color	Pkg. Qty.	Wt. Ea. (lbs.)	Product Class	Specifications
DS-670	2 ft. Plastic Perforated Channel Grate	Light Gray	1	2.81	25DS	2 ft. Structural Foam Polyolefin, secured Channel Grate with UV inhibitor, light traffic rated, heelproof, ADA compliant. Open surface area 8.75 square inches per foot. 26.77 GPM per foot.
DS-671	2 ft. Plastic Perforated Channel Grate	White	1	2.81	25DS	
 Use with Dura Slope Drains (page 72), Dura Slope Catch Basins (page 74). (see page 79). ADA Compliant/Heelproof.						

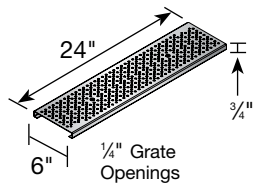

Part No.	Description	Color	Pkg. Qty.	Wt. Ea. (lbs.)	Product Class	Specifications
DS-226	2 ft. Stainless Steel Perforated Channel Grate	Steel	1	3.16	25DS	Perforated Metal Grate, pedestrian traffic rated, heelproof, ADA compliant. Open surface area 7.63 square inches per foot. 23.34 GPM per foot.
DS-228	2 ft. Galvanized Steel Perforated Channel Grate	Steel	1	3.83	25DS	
 Use with Dura Slope Drains (page 72), Dura Slope Catch Basins (page 74). (see page 79). ADA Compliant/Heelproof.						

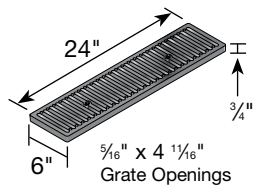

Part No.	Description	Color	Pkg. Qty.	Wt. Ea. (lbs.)	Product Class	Specifications
DS-231	2 ft. Cast Iron Channel Grate	Black	1	18.90	25DS	2 ft. heavy-duty Iron Channel Grate. Open surface area 20.85 square inches per foot. 63.78 GPM per foot. H-20 load rating.
DS-232	2 ft. Ductile Iron	Black	1	15.20	25DS	
 Use with Dura Slope Drains (page 72), Dura Slope Catch Basins (page 74). (see page 79). ADA Compliant. Must be used with DS-200H to achieve Class D Load Rating.						

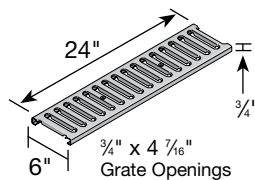

Part No.	Description	Color	Pkg. Qty.	Wt. Ea. (lbs.)	Product Class	Specifications
DS-221	2 ft. Galvanized Steel Channel Grate	Steel	1	6.64	25DS	2 ft. Galvanized Rolled Steel Grate. Open surface area 23.09 square inches per foot. 70.64 GPM per foot.
 Use with Dura Slope Drains (page 72), Dura Slope Catch Basins (page 74). Includes bracket to attach grate to channel and screws. (see page 79)						

DURA SLOPE™ TRENCH DRAIN – PRE-SLOPED

Slot Top



Part No.	Description	Color	Pkg. Qty.	Wt. Ea. (lbs.)	Product Class
DS-ST4	4 ft. Slot Top with Galvanized Steel Grate	Galvanized Steel	1	17.53	25DS
DS-ST2	2 ft. Slot Top with Galvanized Steel Grate	Galvanized Steel	1	8.86	25DS
DS-STMAINT	2 ft. Slot Top Maintenance Unit	Galvanized Steel	1	14.86	25DS
DS-SS-ST1000	48 in. Slot Top, Asymmetric, Stainless Steel, NW 113, C 250KN, SW 15, 1218/151/133, SH 110	Stainless Steel	1	17.13	25DS
DS-SS-ST500	24 in. Slot Top, Asymmetric, Stainless Steel, NW 113, C 250KN, SW 15, 609/151/133, SH 110	Stainless Steel	1	8.86	25DS
DS-SS-STMAINT	24 in. Maintenance Unit Stainless Steel, NW 113, Asymmetric, SW 15 cl. C 250 KN	Stainless Steel	1	14.86	25DS
13399	Opening Tool for Maintenance Unit (order 2)	N/A	1	0.02	25FC

Decorative Grates

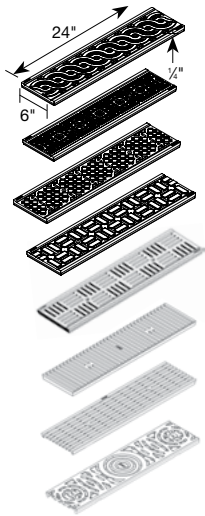

Part No.	Description	Color	Pkg. Qty.	Wt. Ea. (lbs.)	Product Class	Specifications
DS-601	Weave Pattern	Raw Iron	1	14.50	25DS	Decorative grates are made of ductile iron. Weave: open area 6.75 square inches per foot; 20.65 GPM. Diamond: open area 9.55 square inches per foot; 29.21 GPM. Tile: open area 7.95 square inches per foot; 24.32 GPM. Brick: open area 11.35 square inches per foot; 34.725 GPM. Deco slot: open area 16.75 square inches per foot; 51.24 GPM.
DS-602	Diamond Pattern	Raw Iron	1	14.30	25DS	
DS-603	Tile Pattern	Raw Iron	1	14.70	25DS	
DS-604	Brick Pattern	Raw Iron	1	14.30	25DS	
DS-609	Deco Slot	Raw Iron	1	14.50	25DS	
DS-610-KIARO	Kiaro Slot	Ductile Iron	1	14.99	25DS	
DS-611-VIA	Via Slot	Ductile Iron	1	10.36	25DS	
DS-612-VILLE	Ville Pattern	Ductile Iron	1	11.68	25DS	
Use with Dura Slope Drains (page 72), Dura Slope Catch Basins (see below). Decorative grates are made of ductile iron. Uncoated raw iron will develop a rust patina over time. (see page 79). ADA Compliant/Heel-proof. Must be used with DS-200H to achieve Class D Load Rating.						

In-Line Catch Basin

The NDS Dura Slope™ in-line catch basin is designed to fit all depth ranges of the Dura Slope™ trench drain sections. Catch basin inlets are designed to be sized as required to accept the Dura Slope™ trench drain section. The Dura Slope™ catch basin is 2 feet long and 2 feet deep with an outlet on both sides of the basin. One Universal Adapter Plug, one blank grate insert and two grate screws are included with each Dura Slope™ in-line catch basin. The NDS universal basin outlets are used to adapt the catch basin to 3", 4", 6" and 8" pipe.

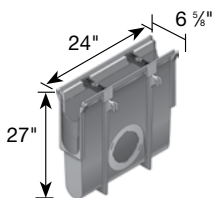

Part No.	Description	Color	Pkg. Qty.	Wt. Ea. (lbs.)	Product Class
DS-340	Dura Slope™ In-Line Catch Basins	Light Gray	1	12.00	25DS
Available for use of one or two outlets. Use #1242, #1243, #1245, #1246, #1206 or #1888 Universal Outlets (see page 35).					

DURA SLOPE™ TRENCH DRAIN – PRE-SLOPED

Trash Bucket

Dura Slope™ Trash Bucket is made to fit inside the Dura Slope™ Catch Basin (part number DS-340). It has a handle for easy removal to clean leaves and debris; it requires removal of the grate. Made of zinc plated steel, it is durable to climatic conditions. The Trash Bucket is not intended for use with any of the Dura Slope™ Channels. *Note: DS-240 Trash Bucket is not for use with the DS-200H Ductile Iron Frame.*

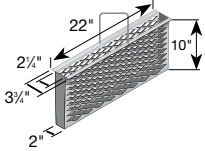

Part No.	Description	Color	Pkg. Qty.	Wt. Ea. (lbs.)	Product Class
DS-240	Dura Slope™ Trash Bucket	Steel Zinc-Plated Steel	1	5.00	25DS

Accessories

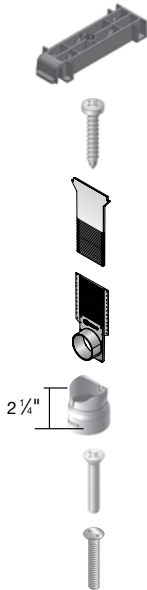

Part No.	Description	Color	Pkg. Qty.	Wt. Ea. (lbs.)	Product Class
DS-122	ProFit™ Grate Lock	Black	8	0.80	25DS
DS-123	Dura Slope Frame & End Cap Screws PH. #6	Steel	12		25DS
	Use on DS-229 Universal End Cap & DS-227 x 3/4". Universal End Outlet downstream for (male) end. Use to attach DS-200 DI Frame to Channel.				
DS-224	Universal End Cap	Gray	8	0.63	25DS
	Replaces DS-124, which will not work with DS-113 or deeper channels. Slides into upstream (female) end. Requires DS-123 screws on downstream (male) end.				
DS-227	Universal End Outlet	Gray	6	0.75	25DS
	Replaces DS-127, which will not work with DS-113 or deeper channels. Requires DS-123 screws for use on downstream (male) end. Fits to 4" S&D Pipe.				
DS-126	Bottom Outlet Adapter	Gray	6	0.53	25DS
	Fits to 4" S&D Pipe. DS-126 not required for Sch. 40 connection.				
629	Grate Screws FH # 1/4 – 20 x 1-1/2"	Stainless Steel	40	0.70	25PF
	2 Needed per Grate. Use with Grate # DS-231, DS-232, DS-670, DS-226 and 660-665. Use to secure grates in applications without DS-200 DI Frame				
DS-225	Dura Slope™ Ductile Iron Frame Screws FH #1/4-20 x 2-1/2"	Steel	12	0.05	25DS
	Only Needed with DS-200H Frame. 2 Needed per Grate.				
DS-650	Flat Drilled Spanner End Cap Screws #6, 3/4"	Steel	12	1	25DS
	Drill bit included with each package.				

Ductile Iron Frame

Dura Slope Ductile Iron Frame provides a Class D load rating of 326-575 psi and is suitable for heavy-duty hard tire equipment at speeds less than 20 mph. The DS-200H Ductile Iron Frame is recommended for use with pneumatic tire traffic such as fork lifts. The ductile iron frame can be used with the cast and ductile iron grates. *Note: DS-123 screws must be ordered to secure frame to the channel.*

Part No.	Description	Color	Pkg. Qty.	Wt. Ea. (lbs.)	Product Class
DS-200H	Dura Slope™ Ductile Iron Frame	Black	2 ft.	7.50	25DS
	Use with Dura Slope Drains (page 72), Dura Slope Catch Basins (page 74). To be used with DS-231 or DS-232 grates. New Feature: 1/4" Brass Nuts to secure channel inserted. (see page 79). ADA Compliant/Heel-proof when used with DS-231 or DS-232 grates.				

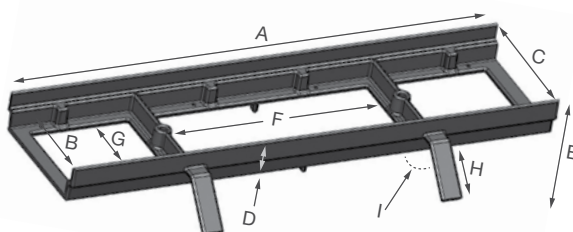

Dimension Key		
A	Length	24"
B	Inner Width	6"
C	Outer Width	6-3/8"
D	Added Profile	1" Height
E	Total Height	2-3/4"
F	Opening Length	10-3/4"
G	Opening Width	4-1/2"
H	Length of Anchor	2-5/8"
I	Angle of Anchor	30°

DURA SLOPE™ TRENCH DRAIN – PRE-SLOPED

Radius Coupling & Grates

Patent Pending

CHANNEL & TRENCH DRAINS

Designed specifically for draining 400-meter running tracks, Dura Slope™ Radius Couplings allow 3 degrees of deflection between trench drain sections, making an adjustable radius easily achievable for standard tracks and other curving applications.



Details

- 80'-120' radius
- Heavy-duty HDPE trench drain
- No Special tools required components snap into place
- Four depths available
- Grate options: standard & slotted
- Flexible radius coupling (patent pending)

Radius Coupling

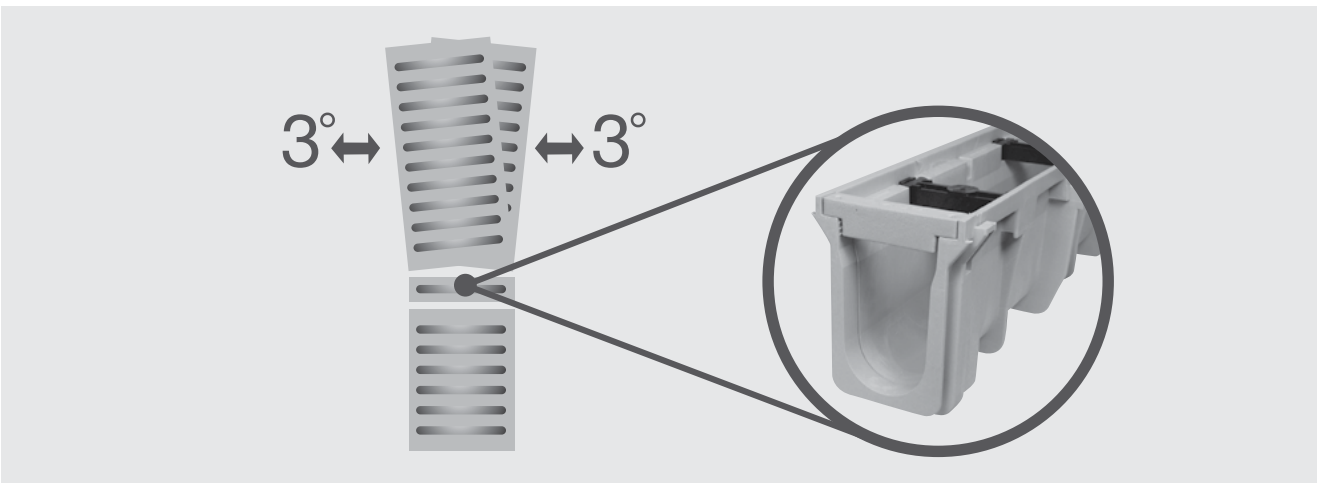

DURA SLOPE™ TRENCH DRAIN – PRE-SLOPED

EZ-Track™ Radius Coupling & Grates



Part No.	Description	Color	Pkg. Qty.	Wt. Ea. (lbs.)	Product Class	Specifications
DSRC-097	6.35" Deep Neutral Dura Slope™ Radius Coupling	Light Gray	6	0.81	25DS	3 degree max. deflection per coupling. Minimum inside radius of 26".
DSRC-100	7.36" Deep Neutral Dura Slope™ Radius Coupling	Light Gray	6	0.82	25DS	
DSRC-103	8.37" Deep Neutral Dura Slope™ Radius Coupling	Light Gray	6	0.83	25DS	
DSRC-106	9.37" Deep Neutral Dura Slope™ Radius Coupling	Light Gray	6	0.84	25DS	
DSRC	Dura Slope™ Radius Coupling	Light Gray	6	0.86	25DS	



Part No.	Description	Color	Pkg. Qty.	Wt. Ea. (lbs.)	Product Class	Specifications
DS-660MG	1.25" Plastic Slotted Radius Coupling Grate	White	6	0.15	25DS	Structural Foam Polyolefin Radius Coupling Channel Grate with UV inhibitor. Open surface area 1.88 square inches per grate. 5.75 GPM per grate.
DS-661MG	1.25" Plastic Slotted Radius Coupling Grate	Dark Gray	6	0.15	25DS	
DS-661LGMG	1.25" Plastic Slotted Radius Coupling Grate	Light Gray	6	0.15	25DS	
DS-662MG	1.25" Plastic Slotted Radius Coupling Grate	Green	6	0.15	25DS	
DS-663MG	1.25" Plastic Slotted Radius Coupling Grate	Black	6	0.15	25DS	
DS-664MG	1.25" Plastic Slotted Radius Coupling Grate	Sand	6	0.15	25DS	
DS-665MG	1.25" Plastic Slotted Radius Coupling Grate	Brick Red	6	0.15	25DS	



Part No.	Description	Color	Pkg. Qty.	Wt. Ea. (lbs.)	Product Class	Specifications
DS-681LGMG	1.25" Plastic Standard Radius Coupling Grate (no slot)	Light Gray	6	0.16	25DS	Solid Structural Foam Polyolefin Radius Coupling Channel Grate with UV inhibitor.

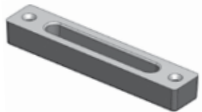

Part No.	Description	Color	Pkg. Qty.	Wt. Ea. (lbs.)	Product Class	Specifications
DS-232MG	1.25" Ductile Iron Radius Coupling Grate	Black	6	0.93	25DS	Ductile Iron Radius Coupling Channel Grate. Open surface area 1.88 square inches per grate. 5.75 GPM per grate.



Part No.	Description	Color	Pkg. Qty.	Wt. Ea. (lbs.)	Product Class	Specifications
DS-226MG	1.25" Perforated Stainless Steel Radius Coupling Grate	Steel	6	0.25	25DS	Stainless Steel Radius Coupling Channel Grate. Open surface area 0.86 square inches per grate. 2.63 GPM per grate.



Part No.	Description	Color	Pkg. Qty.	Wt. Ea. (lbs.)	Product Class	Specifications
DS-221MG	1.25" Galvanized Steel Radius Coupling Grate	Steel	6	0.33	25DS	Galvanized Steel Coupling Channel Grate. Open surface area 1.31 square inches per grate. 4.01 GPM per grate.

CHANNEL & TRENCH DRAINS

DURA SLOPE™ TRENCH DRAIN – PRE-SLOPED

Dura Slope™ System Profiles

CHANNEL & TRENCH DRAINS

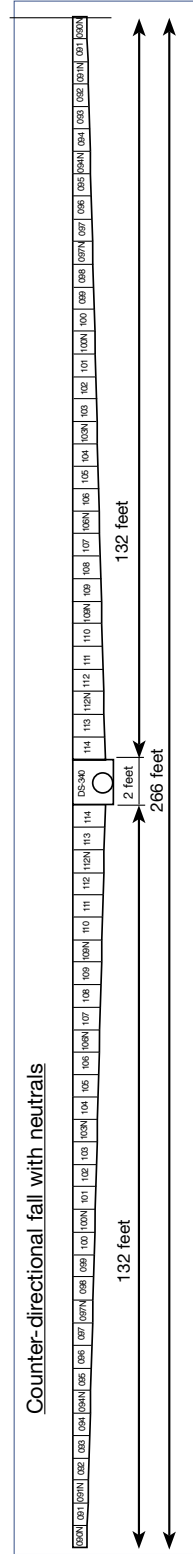
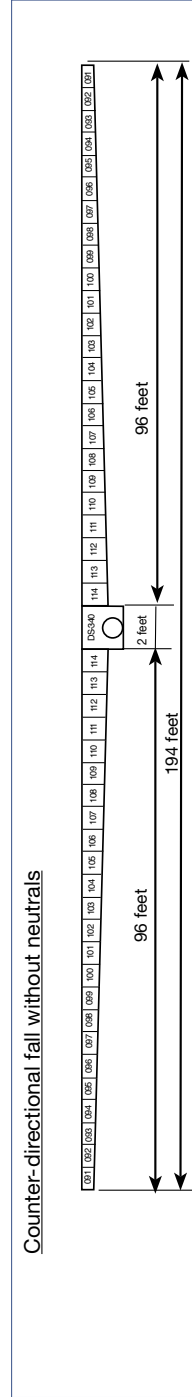
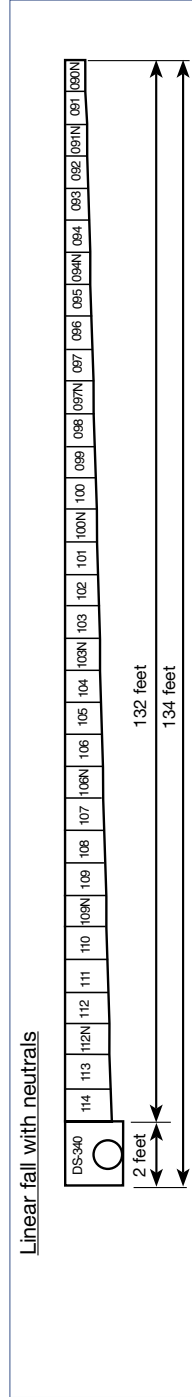
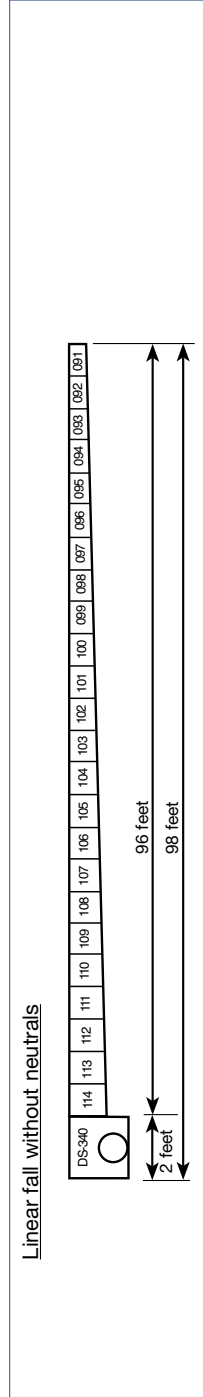
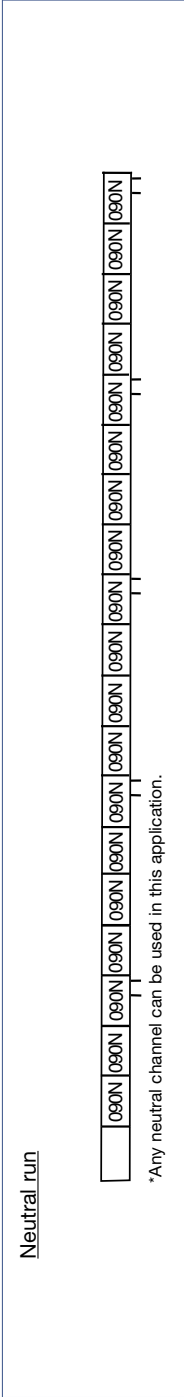

Note: Drawings are not to scale. See previous pages for actual product dimensions.

LOAD RECOMMENDATION GUIDE

NDS Class A

- Loads of 1-60 psi.
- Recommended for pedestrians, bicycles and wheelchair traffic.



NDS Class B

- Loads of 61-175 psi.
- Recommended for medium-duty pneumatic tire traffic, autos and light trucks at speeds less than 20 m.p.h.



NDS Class C

- Loads of 176-325 psi.
- Recommended for heavy-duty pneumatic tire forklifts and tractor-trailers at speeds less than 20 m.p.h., H-20 rated.



NDS Class D

- Loads of 326-575 psi.
- Recommended for heavy-duty hard tire forklifts at speeds less than 20 m.p.h., H-20 rated.



Notes: Some installations may require a concrete collar to meet load rating. Load ratings are based on encasing product in concrete. Product must be installed using NDS instructions.

Cast iron grates will oxidize over time and rust, forming an iron-oxide patina. The iron-oxide layer begins red-orange in color and ages to a deep, rich brown. This patina is tightly adhered and protects the iron beneath it from further oxidation. Iron grates with a rust patina are structurally sound and will last for decades.

Visit [ndspro.com](https://www.ndspro.com) for complete installation specifications, guidelines & details.

BG-FILCOTEN®

A Heavyweight When it Comes to Features

BG-FILCOTEN® combines smart engineering and smart materials to provide a superior trench drain suitable for handling a high load capacity. Combining the features of a stable concrete channel with the strength, durability and environmental-friendliness of fiber-reinforced concrete, BG-FILCOTEN® is the ideal choice for a wide variety of sites and applications.

Applications

Because BG-FILCOTEN® can handle a high load capacity, it is especially suitable for installation in industrial areas such as factories, garages and parking lots. With its sleek design it can easily be used in public places like railway stations, and pedestrian or residential areas. reinforced concrete, BG-FILCOTEN® is the ideal choice for a wide variety of sites and applications.

Product Features & Benefits

- Temperature, frost and UV resistant. Less contraction and expansion and longer product life.
- 100% recyclable/0% harmful substances. Sustainable solution without VOCs or heavy-metal residue that can leach into the ground. Qualifies for LEED credits.
- Non-flammable. Manufactured without resins, BG-FILCOTEN® is rated A1, non-combustible.
- Monolithic adhesion. Free from de-molding agents, BG-FILCOTEN® bonds securely with the surrounding concrete.

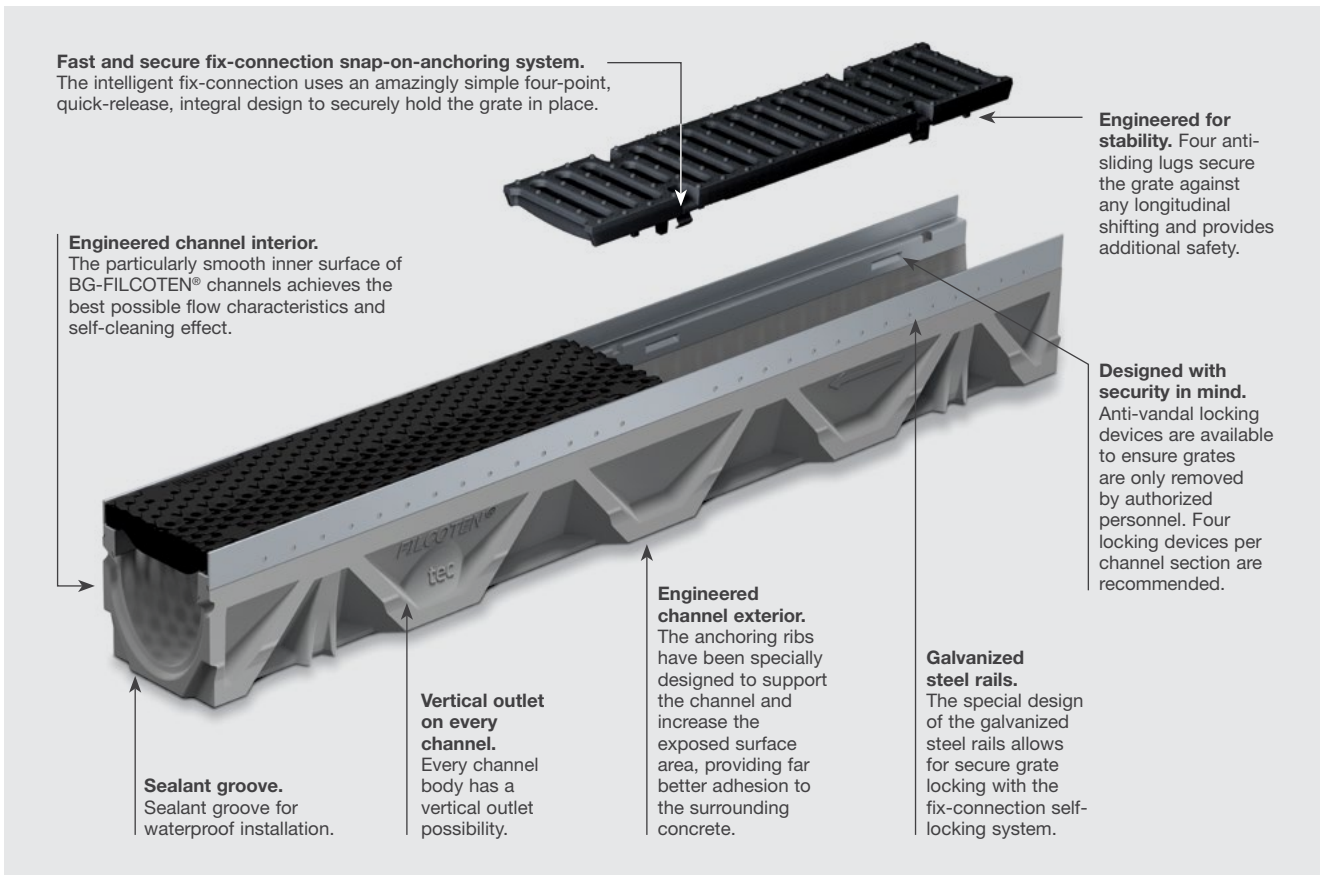

BG-FILCOTEN®

4" BG-FILCOTEN TEC V 100 Trench Drain

Tech V 100 Galvanized Steel Trench Drain

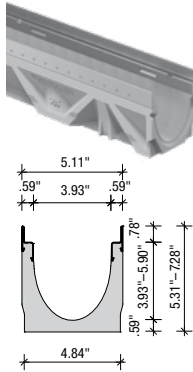

Part No.	Description	Material	Carton Qty.	Weight Ea. (lbs.)	Length Ea. (in.)	Product Class
10410200	BG-FILCOTEN Tec V 100 Channel 0 without slope	Galvanized Rail	1	28.88	39.37	25FC
10410201	BG-FILCOTEN Tec V 100 Channel 1 with .5% slope	Galvanized Rail	1	29.32	39.37	25FC
10410202	BG-FILCOTEN Tec V 100 Channel 2 with .5% slope	Galvanized Rail	1	30.20	39.37	25FC
10410203	BG-FILCOTEN Tec V 100 Channel 3 with .5% slope	Galvanized Rail	1	30.86	39.37	25FC
10410204	BG-FILCOTEN Tec V 100 Channel 4 with .5% slope	Galvanized Rail	1	31.75	39.37	25FC
10410205	BG-FILCOTEN Tec V 100 Channel 5 with .5% slope	Galvanized Rail	1	32.63	39.37	25FC
10410206	BG-FILCOTEN Tec V 100 Channel 6 with .5% slope	Galvanized Rail	1	33.51	39.37	25FC
10410207	BG-FILCOTEN Tec V 100 Channel 7 with .5% slope	Galvanized Rail	1	34.29	39.37	25FC
10410208	BG-FILCOTEN Tec V 100 Channel 8 with .5% slope	Galvanized Rail	1	35.05	39.37	25FC
10410209	BG-FILCOTEN Tec V 100 Channel 9 with .5% slope	Galvanized Rail	1	35.94	39.37	25FC
10410210	BG-FILCOTEN Tec V 100 Channel 10 with .5% slope	Galvanized Rail	1	36.82	39.37	25FC
10410261	BG-FILCOTEN Tec V 100 Channel 5-0 without slope	Galvanized Rail	1	33.07	39.37	25FC
10410262	BG-FILCOTEN Tec V 100 Channel 10-0 without slope	Galvanized Rail	1	37.26	39.37	25FC
10410211	BG-FILCOTEN Tec V 100 Channel 11 with .5% slope	Galvanized Rail	1	29.54	39.37	25FC
10410212	BG-FILCOTEN Tec V 100 Channel 12 with .5% slope	Galvanized Rail	1	31.09	39.37	25FC
10410213	BG-FILCOTEN Tec V 100 Channel 13 with .5% slope	Galvanized Rail	1	32.63	39.37	25FC
10410214	BG-FILCOTEN Tec V 100 Channel 14 with .5% slope	Galvanized Rail	1	33.95	39.37	25FC
10410215	BG-FILCOTEN Tec V 100 Channel 15 with .5% slope	Galvanized Rail	1	35.05	39.37	25FC
10410216	BG-FILCOTEN Tec V 100 Channel 16 with .5% slope	Galvanized Rail	1	36.16	39.37	25FC
10410217	BG-FILCOTEN Tec V 100 Channel 17 with .5% slope	Galvanized Rail	1	37.04	39.37	25FC
10410218	BG-FILCOTEN Tec V 100 Channel 18 with .5% slope	Galvanized Rail	1	38.36	39.37	25FC
10410219	BG-FILCOTEN Tec V 100 Channel 19 with .5% slope	Galvanized Rail	1	39.68	39.37	25FC
10410220	BG-FILCOTEN Tec V 100 Channel 20 with .5% slope	Galvanized Rail	1	40.79	39.37	25FC
10410264	BG-FILCOTEN Tec V 100 Channel 20-0 without slope	Galvanized Rail	1	41.23	39.37	25FC

MTO: 6-7 week lead time

CHANNEL & TRENCH DRAINS

BG-FILCOTEN®

8" BG-FILCOTEN PRO V 200 Trench Drain

Pro 200 Galvanized Steel Trench Drain

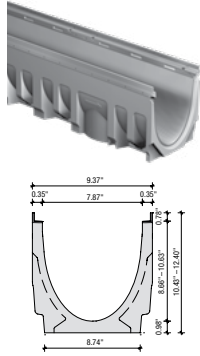

Part No.	Description	Material	Carton Qty.	Weight Ea. (lbs.)	Length Ea. (in.)	Product Class
10620200	BG-FILCOTEN Pro V 200 Channel 0 without slope	Galvanized Rail	1	97.00	39.37	25FC
10620201	BG-FILCOTEN Pro V 200 Channel 1 with .5% slope	Galvanized Rail	1	98.11	39.37	25FC
10620202	BG-FILCOTEN Pro V 200 Channel 2 with .5% slope	Galvanized Rail	1	100.31	39.37	25FC
10620203	BG-FILCOTEN Pro V 200 Channel 3 with .5% slope	Galvanized Rail	1	102.51	39.37	25FC
10620204	BG-FILCOTEN Pro V 200 Channel 4 with .5% slope	Galvanized Rail	1	104.72	39.37	25FC
10620205	BG-FILCOTEN Pro V 200 Channel 5 with .5% slope	Galvanized Rail	1	106.92	39.37	25FC
10620206	BG-FILCOTEN Pro V 200 Channel 6 with .5% slope	Galvanized Rail	1	109.13	39.37	25FC
10620207	BG-FILCOTEN Pro V 200 Channel 7 with .5% slope	Galvanized Rail	1	111.33	39.37	25FC
10620208	BG-FILCOTEN Pro V 200 Channel 8 with .5% slope	Galvanized Rail	1	113.54	39.37	25FC
10620209	BG-FILCOTEN Pro V 200 Channel 9 with .5% slope	Galvanized Rail	1	115.74	39.37	25FC
10620210	BG-FILCOTEN Pro V 200 Channel 10 with .5% slope	Galvanized Rail	1	117.95	39.37	25FC
10620261	BG-FILCOTEN Pro V 200 Channel 5-0 without slope	Galvanized Rail	1	108.30	39.37	25FC
10620262	BG-FILCOTEN Pro V 200 Channel 10-0 without slope	Galvanized Rail	1	118.83	39.37	25FC
10620264	BG-FILCOTEN Pro V 200 Channel 20-0 without slope	Galvanized Rail	1	138.23	39.37	25FC
10620211	BG-FILCOTEN Pro V 200 Channel 11 with .5% slope	Galvanized Rail	1	199.42	39.37	25FC
10620212	BG-FILCOTEN Pro V 200 Channel 12 with .5% slope	Galvanized Rail	1	203.51	39.37	25FC
10620213	BG-FILCOTEN Pro V 200 Channel 13 with .5% slope	Galvanized Rail	1	207.59	39.37	25FC
10620214	BG-FILCOTEN Pro V 200 Channel 14 with .5% slope	Galvanized Rail	1	211.68	39.37	25FC
10620215	BG-FILCOTEN Pro V 200 Channel 15 with .5% slope	Galvanized Rail	1	215.77	39.37	25FC
10620216	BG-FILCOTEN Pro V 200 Channel 16 with .5% slope	Galvanized Rail	1	219.86	39.37	25FC
10620217	BG-FILCOTEN Pro V 200 Channel 17 with .5% slope	Galvanized Rail	1	223.95	39.37	25FC
10620218	BG-FILCOTEN Pro V 200 Channel 18 with .5% slope	Galvanized Rail	1	228.03	39.37	25FC
10620219	BG-FILCOTEN Pro V 200 Channel 19 with .5% slope	Galvanized Rail	1	232.12	39.37	25FC
10620220	BG-FILCOTEN Pro V 200 Channel 20 with .5% slope	Galvanized Rail	1	236.21	39.37	25FC
10620290	BG-FILCOTEN Pro V 200 Sump	Galvanized Rail	1	105.82	19.69	25FC

12" BG-FILCOTEN PRO V 300 Trench Drain

Pro V 300 Galvanized Steel Trench Drain

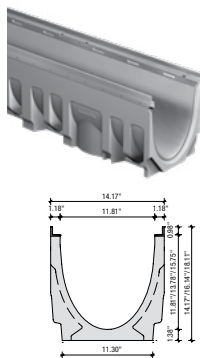

Part No.	Description	Material	Carton Qty.	Weight Ea. (lbs.)	Length Ea. (in.)	Product Class
10630201	BG-FILCOTEN Pro V 300 Channel 1 with .5" slope	Galvanized Rail	1	168.21	39.37	25FC
10630202	BG-FILCOTEN Pro V 300 Channel 2 with .5" slope	Galvanized Rail	1	171.08	39.37	25FC
10630203	BG-FILCOTEN Pro V 300 Channel 3 with .5" slope	Galvanized Rail	1	173.94	39.37	25FC
10630204	BG-FILCOTEN Pro V 300 Channel 4 with .5" slope	Galvanized Rail	1	176.81	39.37	25FC
10630205	BG-FILCOTEN Pro V 300 Channel 5 with .5" slope	Galvanized Rail	1	179.67	39.37	25FC
10630206	BG-FILCOTEN Pro V 300 Channel 6 with .5" slope	Galvanized Rail	1	182.54	39.37	25FC
10630207	BG-FILCOTEN Pro V 300 Channel 7 with .5" slope	Galvanized Rail	1	185.41	39.37	25FC
10630208	BG-FILCOTEN Pro V 300 Channel 8 with .5" slope	Galvanized Rail	1	188.27	39.37	25FC
10630209	BG-FILCOTEN Pro V 300 Channel 9 with .5" slope	Galvanized Rail	1	191.14	39.37	25FC
10630210	BG-FILCOTEN Pro V 300 Channel 10 with .5" slope	Galvanized Rail	1	194.00	39.37	25FC
10630200	BG-FILCOTEN Pro V 300 Channel 0 without slope	Galvanized Rail	1	166.67	39.37	25FC
10630261	BG-FILCOTEN Pro V 300 Channel 5-0 without slope	Galvanized Rail	1	181.00	39.37	25FC
10630262	BG-FILCOTEN Pro V 300 Channel 10-0 without slope	Galvanized Rail	1	195.33	39.37	25FC
10630264	BG-FILCOTEN Pro V 300 Channel 20-0 without slope	Galvanized Rail	1	240.30	39.37	25FC
10630211	BG-FILCOTEN Pro V 300 Channel 11 with .5% slope	Galvanized Rail	1	199.42	39.37	25FC
10630212	BG-FILCOTEN Pro V 300 Channel 12 with .5% slope	Galvanized Rail	1	203.51	39.37	25FC
10630213	BG-FILCOTEN Pro V 300 Channel 13 with .5% slope	Galvanized Rail	1	207.59	39.37	25FC
10630214	BG-FILCOTEN Pro V 300 Channel 14 with .5% slope	Galvanized Rail	1	211.68	39.37	25FC
10630215	BG-FILCOTEN Pro V 300 Channel 15 with .5% slope	Galvanized Rail	1	215.77	39.37	25FC
10630216	BG-FILCOTEN Pro V 300 Channel 16 with .5% slope	Galvanized Rail	1	219.86	39.37	25FC
10630217	BG-FILCOTEN Pro V 300 Channel 17 with .5% slope	Galvanized Rail	1	223.95	39.37	25FC
10630218	BG-FILCOTEN Pro V 300 Channel 18 with .5% slope	Galvanized Rail	1	228.03	39.37	25FC
10630219	BG-FILCOTEN Pro V 300 Channel 19 with .5% slope	Galvanized Rail	1	232.12	39.37	25FC
10630220	BG-FILCOTEN Pro V 300 Channel 20 with .5% slope	Galvanized Rail	1	236.21	39.37	25FC
10630290	BG-FILCOTEN Crate Basin	Galvanized Rail	1	273.37		25FC

BG-FILCOTEN®

BG-FILCOTEN TEC V 100 Grates

CHANNEL & TRENCH DRAINS

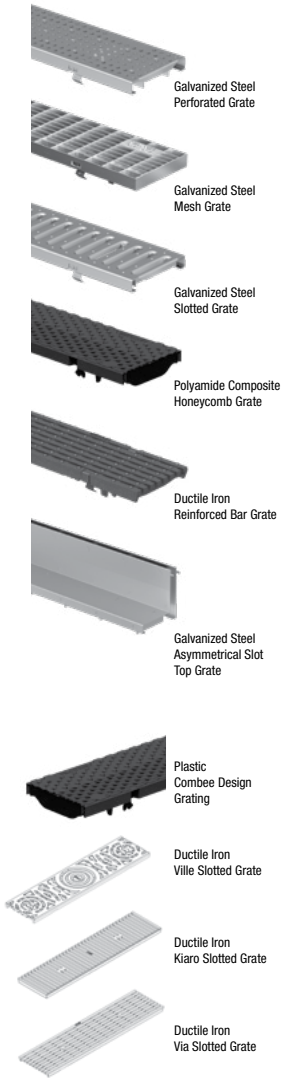

Part No.	Description	Material	Carton Qty.	Weight Ea. (lbs.)	Length Ea. (in.)	Product Class
17010105	BG-FILCOTEN 100 DI Slotted Grate Class E 19.69 in	Ductile Iron	1	8.38	19.69	25FC
17010106	BG-FILCOTEN 100 DI Bar Grate ADA/Heelproof Class C 19.69 in	Ductile Iron	1	7.94	19.69	25FC
17010110	BG-FILCOTEN 100 DI Bar Grate Class D 19.69 in	Ductile Iron	1	7.50	19.69	25FC
17010202	BG-FILCOTEN 100 G Slotted Grate Class A 39.37 in	Galvanized Steel	1	3.31	39.37	25FC
17010203	BG-FILCOTEN 100 G Slotted Grate Class A 19.69 in	Galvanized Steel	1	1.76	19.69	25FC
17010204	BG-FILCOTEN 100 G Perforated Grate Class A 39.37 in	Galvanized Steel	1	4.19	39.37	25FC
17010205	BG-FILCOTEN 100 G Perforated Grate Class A 19.69 in	Galvanized Steel	1	2.20	19.69	25FC
17010206	BG-FILCOTEN 100 G Slotted Grate Class C 39.37 in	Galvanized Steel	1	9.92	39.37	25FC
17010207	BG-FILCOTEN 100 G Slotted Grate Class C 19.69 in	Galvanized Steel	1	4.85	19.69	25FC
17010220	BG-FILCOTEN 100 G Mesh Grate Class B 39.37 in	Galvanized Steel	1	6.17	39.37	25FC
17010221	BG-FILCOTEN 100 G Mesh Grate Class B 19.69 in	Galvanized Steel	1	3.09	19.69	25FC
17010228	BG-FILCOTEN 100 G Perforated Grate Class C 39.37 in	Galvanized Steel	1	7.28	39.37	25FC
17010229	BG-FILCOTEN 100 G Perforated Grate Class C 19.69 in	Galvanized Steel	1	3.75	19.69	25FC
17010402	BG-FILCOTEN 100 P Honeycomb Grate Class C 19.69 in	Plastic	1	2.43	19.69	25FC
17010401	Combee Design Grating (Plastic) NW 100, 500/123/20, Class B 125 KN, With Fix-Locking-System	Plastic	1	2.43	19.69	25DS
17010111	Ductile Iron Design Grate "Ville" NW 100, 500/122/25, Class E 600 KN (Tec, Pro)", Slot Width Maximum 8Mm	Ductile Iron	1	11.46	19.69	25DS
17010183	Ductile Iron Design Grate "Kiaro" NW 100, 500/122/20, Class D 400 KN (Tec, Pro), Slot/Mesh Width 100X5.7mm	Ductile Iron	1	9.48	19.69	25DS
17010184	Ductile Iron Design Grate "Via" NW 100, 500/122/20, Class D 400 KN (Tec, Pro), Slot/Mesh Width 29X6mm	Ductile Iron	1	9.25	19.69	25DS
171114	Slot Top Galvanized Steel NW100, asymmetric, SW 2 X 6 Mm, Class C 250 KN, 1000/123/133 Sh 110	Galvanized Steel	1	11.8	19.69	25FC
171115	Slot Top Galvanized Steel NW100, asymmetric, SW 2 x 6 mm, Class C 250 KN, 500/123/133 SH 110	Galvanized Steel	1	5.98	19.69	25FC
17111304	Slot Top Stainless Steel NW100, asymmetric, SW 2 x 6 mm, Class C 250 KN, 1000/123/133 SH 110	Stainless Steel	1	11.8	19.69	25FC
17111305	Slot Top Stainless Steel NW100, asymmetric, SW 2 x 6 mm, Class C 250 KN, 500/123/133 SH 110	Stainless Steel	1	5.98	19.69	25FC
171116	Maintenance unit Slot Top Galvanized Steel NW100, asymmetric, SW 2 x 6 mm, cl. C 250 KN	Galvanized Steel	1	11.02		25FC
17111306	Maintenance unit Slot Top Stainless Steel NW100, asymmetric, SW 2 x 6 mm, cl. C 250 KN	Stainless Steel	1	11.02		25FC

See load recommendation guide page 87

BG-FILCOTEN®

BG-FILCOTEN PRO V 200 GRATES

CHANNEL & TRENCH DRAINS

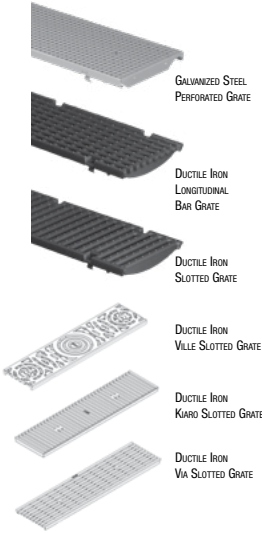

Part No.	Description	Material	Carton Qty.	Weight Ea. (lbs.)	Length Ea. (in.)	Product Class
17020104	BG-FILCOTEN 200 DI Bar Grate Class D 19.69 in	Ductile Iron	1	16.53	19.69	25FC
17020105	BG-FILCOTEN 200DI Bar Grate Class E 19.69 in	Ductile Iron	1	18.96	19.69	25FC
1702021	BG-FILCOTEN 200 G Perforated Grate Class C 39.27 in	Galvanized Steel	1	29.76	39.37	25FC
17020229	BG-FILCOTEN 200 G Perforated Grate Class C 19.69 in	Galvanized Steel	1	14.77	19.69	25FC
17020180	Ductile Iron Design Grate "Ville" NW 200, 500/222/25, Class E 10 KN (Tec, Pro)", Slot Width Maximum 8mm	Ductile Iron	1	23.81	19.69	25DS
17020183	Ductile Iron Design Grate "Kiaro" NW 200, 500/222/20, Class D 400 KN, (Tec, Pro), Slot/Mesh Width 200X5.7mm	Ductile Iron	1	20.72	19.69	25DS
17020184	Ductile Iron Design Grate "Via" NW 200, 500/222/20, Class D 400 KN, (Pro), Slot/Mesh Width 29X6mm	Ductile Iron	1	18.52	19.69	25DS

See load recommendation guide page 87

BG-FILCOTEN PRO V 300 GRATES

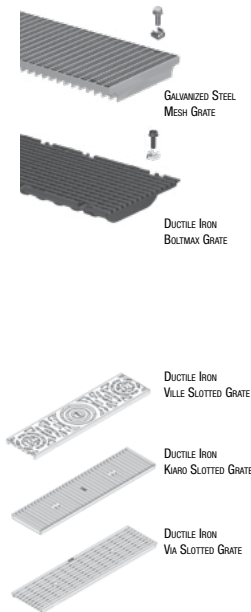

Part No.	Description	Material	Carton Qty.	Weight Ea. (lbs.)	Length Ea. (in.)	Product Class
17030103	BG-FILCOTEN 300 DI Bar Grate Class E 19.69 in	Ductile Iron	1	39.46	19.69	25FC
32110	Bolt for Ductile Grate (Order 4 Per 1/2 meter Grate)					
17030222	BG-FILCOTEN 300 G Mesh Grate Class C 39.37 in	Galvanized Steel	1	50.93	39.37	25FC
32112	Bolt for Galvanized Mesh Grate (Order 4 Per Grate)					
17030223	BG-FILCOTEN 300 G Mesh Grate Class C 19.69 In	Galvanized Steel	1	25.57	19.69	25FC
17030180	Ductile Iron Design Grate "Ville" NW 300, 500/347/25, Class E 600 KN (Pro) 4 Point Bolting-Device", Slot Width Maximum 8mm, Order Bolting Material Separately	Ductile Iron	1	44.09	19.69	25DS
17030183	Ductile Iron Design Grate "Kiaro" NW 300, 500/347/25, Class D 400 KN, (Pro) 4 Point Bolting-Device, Slot/Mesh Width 300X5.7mm, Order Bolting Material Separately	Ductile Iron	1	44.09	19.69	25DS
17030184	Ductile Iron Design Grate "Via" NW 300, 500/347/25, Class D 400 KN, (Pro) 4 Point Bolting-Device, Slot/Mesh Width 29X6mm, Order Bolting Material Separately	Ductile Iron	1	38.58	19.69	25DS

See load recommendation guide page 87

BG-FILCOTEN®

BG-FILCOTEN TEC V 100 Accessories

BG-FILCOTEN Tec Sump Unit 100

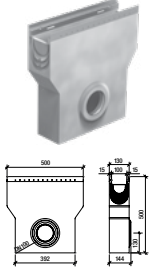

Part No.	Description	Material	Weight Ea. (lbs.)	Product Class
19011204	BG-FILCOTEN No Hub Bottom Outlet	Galvanized Steel	0.66	25FC
22515	BG-FILCOTEN 100 Silt Bucket for Sump	Plastic	0.44	25FC
32087	BG-FILCOTEN 100 Anti-Vandalism Locking Device	Stainless Steel	0.22	25FC
19011204	BG-FILCOTEN 100 Bottom Outlet	Galvanized Steel	0.66	25FC
19010230	BG-FILCOTEN 100 Closed End Cap	Galvanized Steel	0.66	25FC
19010231	BG-FILCOTEN 100 Open End Cap	Galvanized Steel	0.66	25FC
19010902	BG-FILCOTEN 100 Rebar Support	Galvanized Steel	2.7	25FC
13399	BG-FILCOTEN Maintenance Box Opening Tool	N/A	0.22	25FC
10410294	BG-FILCOTEN Tec V 100 Sump Kit	N/A	26.55	25FC

BG-FILCOTEN PRO V 200 Accessories

BG-FILCOTEN Pro Sump Unit 200

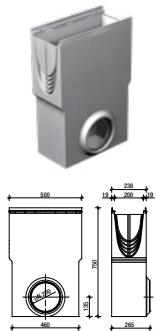

Part No.	Description	Material	Weight Ea. (lbs.)	Product Class
22512	BG-FILCOTEN 200 Silt Bucket for Sump	Plastic	1.54	25FC
32089	BG-FILCOTEN 200 Grate Vandal-Proof Device	Stainless Steel	0.22	25FC
70154	BG-FILCOTEN 8" Pipe Connector for Catch Basin	Plastic	2.43	25FC
19020215	BG-FILCOTEN 200 Closed End Cap	Galvanized Steel	0.88	25FC
19020216	BG-FILCOTEN 200 End Cap with Outlet	Galvanized Steel	1.10	25FC
19020295	BG-FILCOTEN Step Connector Plate	Galvanized Steel	0.44	25FC
19020902	BG-FILCOTEN No Hub Bottom Outlet	Galvanized Steel	2.20	25FC
19020902	BG-FILCOTEN Rebar Support	Galvanized Steel	1.8	25FC
19021208	BG-FILCOTEN No Hub Bottom Outlet	Galvanized Steel	2.2	25FC
10620292	BG-FILCOTEN Catch Basin includes 10620290 catch basin and 22512 Sediment Bucket	Galvanized Rail	180.0	25FC

BG-FILCOTEN PRO V 300 Accessories

BG-FILCOTEN Pro 300 Sump Kit with Silt Bucket

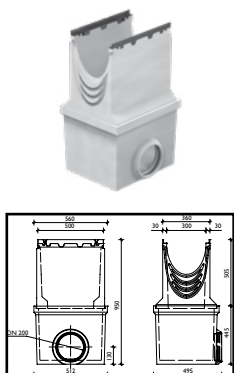

Part No.	Description	Material	Weight Ea. (lbs.)	Product Class
22213	BG-FILCOTEN 300 Silt Bucket for Sump	Galvanized Steel	7.05	25FC
32110	BG-FILCOTEN 300 Bolt and Nut for Locking	Galvanized Steel	0.22	25FC
19030213	BG-FILCOTEN 300 Closed End Cap	Galvanized Steel	3.75	25FC
19030214	BG-FILCOTEN 300 End Cap with Outlet	Galvanized Steel	3.53	25FC
19030290	BG-FILCOTEN 300 Catch Basin End Cap Connector	Galvanized Steel	0.66	25FC
19030295	BG-FILCOTEN 300 Step Connector Plate	Galvanized Steel	0.88	25FC
10630292	BG-FILCOTEN Catch Basin includes 10630290 Catch Basin Body and 22213 Sediment Bucket	Galvanized Rail	273.37	25FC
1903092	BG-FILCOTEN Rebar Support	Galvanized Steel	2.4	25FC

BG-FILCOTEN®

BG-FILCOTEN System Profiles

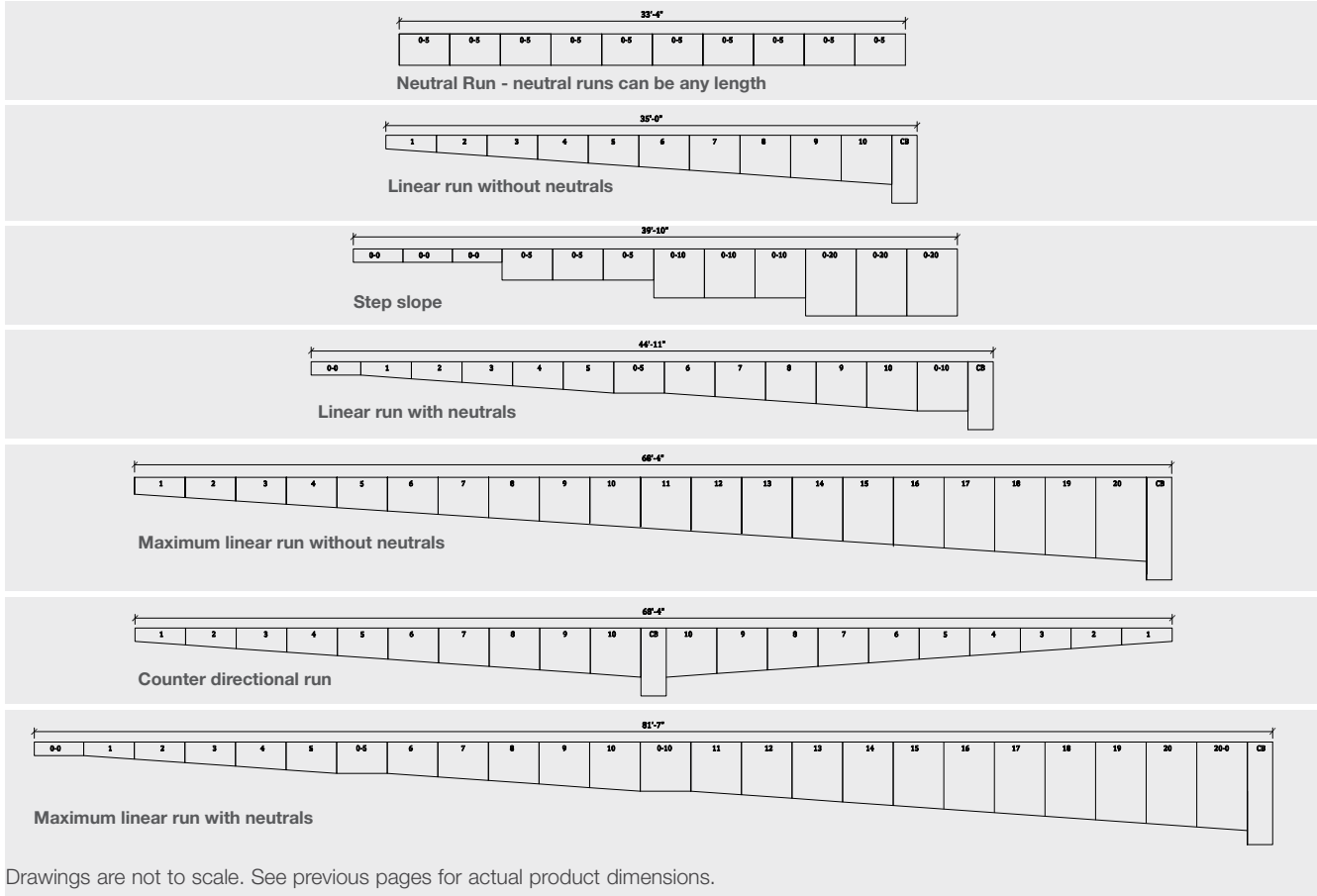

Drawings are not to scale. See previous pages for actual product dimensions.

The maximum run length using only sloped channels with a catch basin in the middle is 135'. The maximum run length with all slopes with 1 each of the neutrals and a catch basin in the middle would be 162'.

BG-FILCOTEN®

LOAD RECOMMENDATION GUIDE – According to EN1433 Standards

Class A

- Max Design Load: 3,372 lbs.
- Pedestrians
- Bicyclists
- Planted Areas



Class B

- Max Design Load: 28,100 lbs.
- Pedestrians
- Parking Lots
- Delivery Vehicles



Class C

- Max Design Load: 56,200 lbs.
- Curbs
- Road Shoulders
- Parking Lots



Class D

- Max Design Load: 89,920 lbs.
- Roadways
- Pedestrian Zones
- Parking Lots



Class E

- Max Design Load: 134,800 lbs.
- Industry
- Military
- High Wheel Loads

Notes: Some installations may require a concrete collar to meet load rating. Load ratings are based on encasing product in concrete. Product must be installed using NDS instructions.

Cast iron grates will oxidize over time and rust, forming an iron-oxide patina. The iron-oxide layer begins red-orange in color and ages to a deep, rich brown. This patina is tightly adhered and protects the iron beneath it from further oxidation. Iron grates with a rust patina are structurally sound and will last for decades.

Visit [ndspro.com](https://www.ndspro.com) for complete installation specifications, guidelines & details.

CHANNEL & TRENCH DRAINS PRODUCTS INDEX

CHANNEL & TRENCH DRAINS

Part No.	Page	Part No.	Page	Part No.	Page	Part No.	Page	Part No.	Page
229	60, 64	665	73	8303	56	10410201	81	10630212	82
230	56, 59, 61	710	64	8381	56	10410202	81	10630213	82
234	61	712	64	8382	56	10410203	81	10630214	82
240	60	713	64	8383	56	10410204	81	10630215	82
241	60	714	64	8461	56	10410205	81	10630216	82
242	60	764	64	8462	56	10410206	81	10630217	82
243	60	800	66	8463	56	10410207	81	10630218	82
244	60	812	66	8471	56	10410208	81	10630219	82
245	61	813	66	8472	56	10410209	81	10630220	82
246	61	814	65	8473	56	10410210	81	10630261	82
247	61	815	65	8481	56	10410211	81	10630262	82
248	61	816	65	8501	56	10410212	81	10630264	82
249	61	817	65	8502	56	10410213	81	10630290	82
251	60	818	65	8503	56	10410214	81	10630292	85
252	60	819	65	8511	56	10410215	81	17010105	83
252CI	60	820	66	8512	56	10410216	81	17010106	83
252GY	60	821	66	8513	56	10410217	81	17010110	83
252S	60	822	66	8601	56	10410218	81	17010180	83
253	60	823	65	8651	56	10410219	81	17010183	83
253CI	60	824	65	8652	56	10410220	81	17010184	83
253GY	60	826	65	8653	56	10410261	81	17010202	83
253S	60	828	65	9206	57	10410262	81	17010203	83
254	60	829	60, 65, 67	9206GKIT	57	10410264	81	17010204	83
400	60	830	68	9206SKIT	57	10410294	85	17010205	83
400-10	60	831	68	9209	57	10620200	82	17010206	83
400-10MTL	60	832	68	9209GRAY	57	10620201	82	17010207	83
400-10WH	60	833	68	9209SAND	57	10620202	82	17010220	83
500	58	834	68	9209WHITE	57	10620203	82	17010221	83
500S	58	836	67	9241	57	10620204	82	17010228	83
529	58, 59	837	67	9242	57	10620205	82	17010229	83
532	59	838	67	9243	57	10620206	82	17010401	83
533	59	840	69	9247	57	10620207	82	17010402	83
540	58	841	69	9248	57	10620208	82	17020104	84
541	58	843	69	9250	57	10620209	82	17020105	84
542	58	844	69	9251	57	10620210	82	17020180	84
543	58	846	58	9252	57	10620211	82	17020183	84
544	58	847	69	9253	57	10620212	82	17020184	84
546	59	849	69	9261	57	10620213	82	17020228	84
546S	59	861	66	9262	57	10620214	82	17020229	84
547	59	862	66	9263	57	10620215	82	17030103	84
547S	59	864	65	9270	57	10620216	82	17030180	84
548	59	864DISPLAY	65	9301	57	10620217	82	17030183	84
548S	59	864GMTL	65	9302	57	10620218	82	17030184	84
550	59	864GMTLDISP	65	9303	57	10620219	82	17030222	84
551	58	885	69	9371	57	10620220	82	17030223	84
552B	58	888	67	9372	57	10620261	82	17111204	83
553PB	58	2301	61	9373	57	10620262	82	17111205	83
554	58	2350	61	9381	57	10620264	82	17111206	83
554CI	58	2351	61	9382	57	10620290	82	17111304	83
554GY	58	2361	61	9383	57	10620292	85	17111305	83
554S	58	2371	61	13399	74, 85	10630200	82	17111306	83
555	58	2381	61	22213	85	10630201	82	19010230	85
555CI	58	5300	59	22512	85	10630202	82	19010231	85
555GY	58	5303	59	22515	85	10630203	82	19010902	85
555S	58	5370	59	32087	85	10630204	82	19011204	85
629	75	5380	59	32089	85	10630205	82	19020215	85
660	73	5383	59	32110	84, 85	10630206	82	19020216	85
661	73	8001	56	32112	84	10630207	82	19020295	85
661LG	73	8002	56	70154	85	10630208	82	19020902	85
662	73	8003	56	1901090	85	10630209	82	19021208	85
663	73	8301	56	1903092	85	10630210	82	19030213	85
664	73	8302	56	10410200	81	10630211	82	19030214	85



PERMEABLE PAVERS

PERMEABLE PAVERS



NDS Permeable Pavers provide an alternative solution to traditional paving methods. Creating a strong grass or gravel surface that can support heavy vehicles, they maintain permeable surface areas, eliminating or reducing stormwater runoff.

Benefits

Greatest Compressive Strength*. Offering a high load-bearing capacity, NDS Permeable Pavers feature hexagonal cells that connect together to form a flexible grid system capable of handling significant structural loads.

Easy Installation. EZ Roll™ products come in large rolls that are easily placed and clipped together. Tufftrack™ features an integrated easy to assemble clip, that greatly reduces installation time.

Reduced Maintenance. Less expensive to maintain over time than traditional hardscaping and reduces demands put on landscape drainage systems.

Environmentally Friendly. NDS Permeable Pavers contribute to LEED credits and are made of up to 100% recycled plastic.

*Compare the strength of NDS Permeable Pavers to the competition.



TUFFTRACK™ GRASS PAVER

PERMEABLE PAVERS



Tufftrack™ Grass Pavers are the strongest paver on the market that works for both grass and gravel applications. Manufactured in rigid 24" square panels it offers maximum strength and stabilization for support of heavy vehicles like fire trucks.

Tufftrack™ Grass Pavers are 24" x 24" rigid panels featuring a clip fastener designed for fast installation that easily connects without extra pieces or tools. The Tufftrack Grass Paver has a combined series of 120 nested hexagonal cells per paver cell with 12 connecting clips. This unique combination provides superior stability and durability.

Ideal Applications

- Fire lanes
- Truck & cart wash-down areas
- Parking lots
- Emergency vehicle access roads
- RV & boat access and parking
- Overflow parking lots
- Truck maintenance and equipment yards
- Residential driveways



Specifications

Tufftrack™ is available in:
24" x 24" panels, 1.5" thick

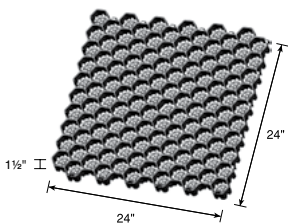
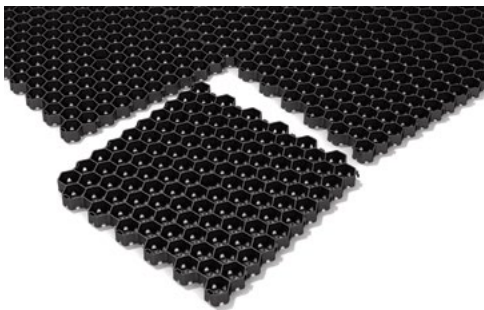

Empty cells have a compressive strength of **86,563 psf**

Cells filled with wet soil have a compressive strength of 400,000 psf

Product ships in 24 in. squares for easy layout

Unique tongue & groove clips are easier to install

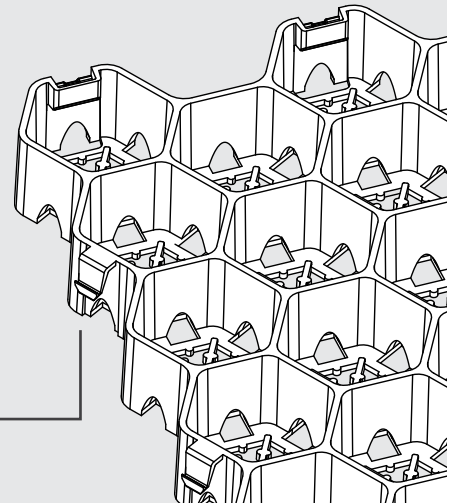

Part No.	Description	Color	Pkg. Qty./ Pallet Qty.	Wt. Ea. Lbs.	Product Class
TT-24	24" x 24" Tufftrack® Grass Pavers	Black	1/132	4.35	55GP

EZ ROLL™ & HONOR ROLL™ GRASS PAVERS



EZ Roll™ Grass Pavers feature hexagonal cells that protect the root zone and prevent soil compaction, allowing healthy grass to thrive in areas that would traditionally have impervious hardscaping installed.

EZ Roll™ Grass Pavers are honeycombed rolled grass pavers that are comprised of 24" x 24" x 1" panels. The product is made of up to 100% recycled HDPE material with UV inhibitors. Panels are available in pre-assembled rolls, and multiple panels and rolls easily connect together with a series of locking joints. EZ Roll Grass Pavers have an ultimate compression load rating of 53,683 psf "empty."

Ideal Applications

- Golf cart paths
- Residential driveways
- Parking lots
- Roadway shoulders
- Emergency vehicle or service access roads – Also an effective solution for erosion control on slopes and in swales



PERMEABLE PAVERS

Specifications

EZ Roll™ Grass Paver

3.96 ft. x 24 ft. rolls –
95.01 square feet total

3.96 ft. x 152 ft. rolls –
601.6 square feet total

(150 ft. +/- 2 ft. on the length
and 3.96 ft. +/- 1/2 in. for width
using 76 panel pairs total)



Empty cells have a
compressive strength of
53,683 psf

Cells filled with wet soil
have a compressive
strength of 400,000 psf

Product ships in large
rolls for easy rollout

Easy to connect locking
tabs on sides and ends

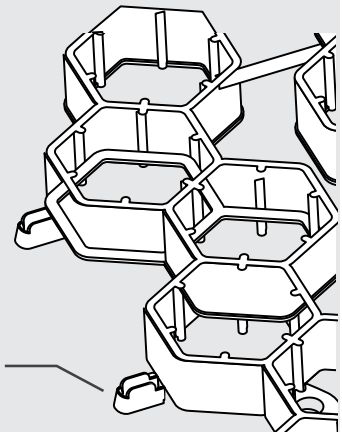

Part No.	Description	Color	Pallet Qty.	Wt. Ea. Lbs.	Product Class
EZ4X24	EZ Roll™ Grass Pavers, 3.96 ft. x 24 ft. roll, 95.01 sf total	Black	6	55.44	55GP
EZ4X150	EZ Roll™ Grass Pavers, 3.96 ft. x 152 ft. roll, 601.6 sf total	Black	1	360.00	55GP

EZ ROLL™ GRAVEL PAVERS



EZ Roll™ Gravel Pavers preserve permeability and help maintain the look and functionality of a gravel road. Made with 100% recycled materials, they also minimize surface water runoff and present an attractive and sustainable alternative to traditional concrete or asphalt.

PERMEABLE PAVERS

NDS EZ Roll™ Gravel Pavers are a high quality injection molded, plastic rolled gravel paver structure of linked and nested honeycomb cells. The product is made from up to 100% recycled HPDE plastic with UV inhibitors. Pavers come in pre-assembled rolls, and a lateral snap lock latching system securely connects paver panels together to create an integral paver mat. Pavers must have an ultimate compression load rating of 53,683 psf (empty).

Ideal Applications

- Golf cart paths
- Service roads
- Jogging tracks
- Bike paths
- RV & boat access & parking
- Residential driveways
- Parking lots
- Roadway shoulders
- Firelanes
- Emergency vehicle access roads
- Truck maintenance and equipment yards
- Effective solution for erosion control on slopes & in swales

Specifications

A continuous piece of geotextile fabric prevents migration of base and infill materials yet is porous to allow for the filtration of stormwater runoff.

Available in three colors for design flexibility. Crushed or decomposed granite, limestone and pea gravel are just some of the fill material options that work well with EZ Roll™ Gravel.



EZ Roll™ Gravel Paver

3.87 ft. x 149 ft. rolls – 577 square feet total

(149 ft. +/- 2 ft. on the length and 3.87 ft. +/- 1/2 in. for width using 76 panel pairs total)

Gravel Paver Stake (GPSTAKE)

Ships with EZ Roll™



Empty cells have a compressive strength of

53,683 psf

Cells filled with 3/8" Gravel have a compressive strength of 500,000 psf

Product ships in large rolls for easy rollout

Easy to connect locking tabs on sides and ends

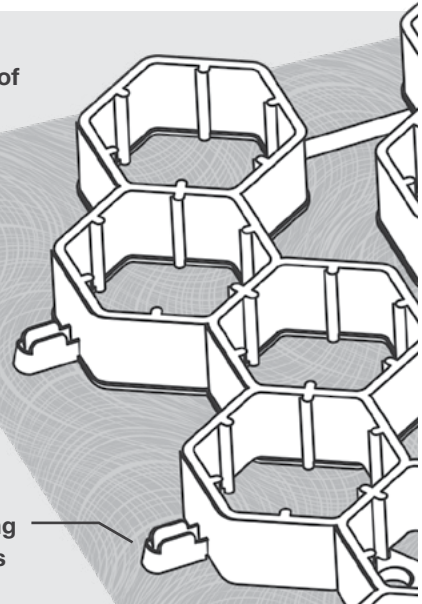

Part No.	Description	Color	Pkg. Qty.	Wt. Ea. Lbs.	Product Class
GP4X150	EZ Roll™ Gravel Pavers, 3.87 ft. x 149 ft. roll, 577 sf total	Black	1	360.00	55GP
GP4X150G	EZ Roll™ Gravel Pavers, 3.87 ft. x 149 ft. roll, 577 sf total*	Gray	1	360.00	55GP
GP4X150T	EZ Roll™ Gravel Pavers, 3.87 ft. x 149 ft. roll, 577 sf total*	Tan	1	360.00	55GP
GPSTAKE	EZ Roll™ Gravel Paver Stake	Raw Steel	40	23.40	55GP

*MTO 3-4 weeks

EZ MARKER™ PARKING DELINEATORS



Used with EZ Roll™ Grass and Gravel Pavers, NDS **EZ Marker™** is a modular solution to outlining driving lanes, parking stalls, and fire lanes. After the pavers have been unrolled, pinned, and secured, EZ Marker™ snaps into the appropriate empty cells to outline whatever pattern necessary to properly direct vehicular traffic.

EZ Marker™ Parking Delineators increase safety and organization by strategically directing parking lot traffic. Delineators are a great way to guide motorists around hazards and to their final parking destination. Used in conjunction with EZ Roll™ Grass and Gravel Permeable Pavers they provide a simple and effective solution for managing parking lot traffic. EZ Marker™ is durable, tamper-resistant and built to last. Available in various colors to suit any traffic need including grass or gravel parking and fire line access.

Specifications

- 2.7" hexagonal shape
- 0.40" profile above paver grade
- Molded polypropylene, impact copolymer
- 300 PSI class "C" compressive strength
- Easy clip-in installation
- Self-cleaning: Raised dome design prevents debris from sticking



Part No.	Description	Color
EZMARKER	EZ Roll™ Parking Delineator	White
EZMARKER-B	EZ Roll™ Parking Delineator	Blue
EZMARKER-R	EZ Roll™ Parking Delineator	Red
EZMARKER-Y	EZ Roll™ Parking Delineator	Yellow

For Permeable Paver Technical Information, Refer to Technical Specification documents at ndspro.com/specifications

PERMEABLE PAVERS PRODUCTS INDEX

Part No.	Page	Part No.	Page	Part No.	Page	Part No.	Page
EZ4X24	93	EZMARKER-B	95	GP4X150	94	GPSTAKE	94
EZ4X150	93	EZMARKER-R	95	GP4X150G	94	TT-24	92
EZMARKER	95	EZMARKER-Y	95	GP4X150T	94		



LANDSCAPE



LANDSCAPE

ROOT BARRIER PANELS



Root barrier products direct root growth from shrubs and trees downward, dramatically decreasing the roots' potential to clash with and penetrate nearby hardscapes, walls, or building foundations. The use of NDS root barriers for residential and non-residential landscapes protects many communities and homeowners against the high cost of reparations due to cracks in foundations and buckled sidewalks and driveways.

Modular EP Series Root Barrier Panels

EP Series Root Barrier Panels are made from injection molded High Impact Polypropylene (HIPP) with a unique factory installed joiner strip that eases installation. EP Series Panels include a "T" top edge to prevent root overgrowth and an Anchor Lock™ external flange at the base to lock panels in the ground. Suitable for all planting installations, EP Series Root Barrier Panels are available in 12", 18", 24" and 36" depths.



Quad Clip™ Joiner Strips



Reinforcing Ribs

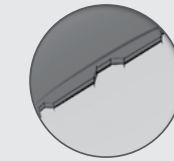
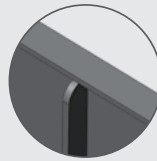

Anchor Lock™

Specifications

EP Series Root Barrier Panels by NDS include factory installed independent joiner strips. Each Barrier is a minimum of 0.090 inches thick and is made of up to 50% post consumer High Impact Polypropylene (HIPP) with U.V. inhibitors to ensure longevity. Barrier Panels have 1/2" raised vertical ribs running perpendicular to the panel and are 6" on center. All EP Series Panels feature a 3/8" wide "T" top edge and an external ground anchoring base flange that is 1/8" in width.

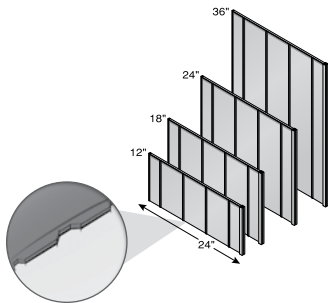

Part No.	Description	Color	Pkg. Qty.	Wt. Ea. Lbs.	Product Class
EP-1250	12" x 24" Root Barrier Panel	Black	25	1.80	50LP
EP-1850	18" x 24" Root Barrier Panel	Black	25	1.56	50LP
EP-2450	24" x 24" Root Barrier Panel	Black	25	2.12	50LP
EP-3650	36" x 24" Root Barrier Panel	Black	25	3.20	50LP
RP-4850	48" x 24" Root Barrier Panel	Black	25	6.20	50LP

Includes 1 Joiner Strip per panel

Recommended Installations

Surround Application:

Panels placed around root ball, at a sufficient distance to allow proper backfill of materials.

Linear/Root Pruning Application:

Panels placed directly adjacent to the hardscape being protected.

ROOT BARRIER PANELS

Root Barrier Sheet Material

Manufactured from durable HDPE, Root Barrier Sheet Material creates a water and root barrier to prevent costly damage to pavements, roads, and building foundations caused by water and roots. The 20-foot-long sheets of material are ideal for linear style planting applications, and are equally suited for individual tree planting use. Root Barrier Sheet Material is available in 12", 18", and 24" depths to meet a variety of applications.

LANDSCAPE

- A - Finished Grade
- B - 3"- 4" of 3/4" Gravel
- C - Amended Soil
- D - Sheet Material

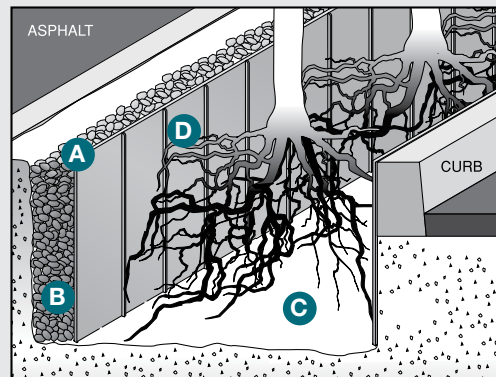

Specifications

Root Barrier Sheet Material by NDS is manufactured from up to 50% recycled HDPE with U.V. inhibitors with a thickness of 0.040 - 0.060". Barriers feature vertically integrated and flared molded 90° root-deflecting ribs that protrude 1/2" from wall and are placed 6-8" apart. A root impervious molded end provides easy assembly using staples or a sealant design to bind to HDPE (a dual-sided solvent-based tape).

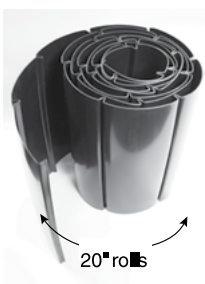

Part No.	Description	Color	Pkg. Qty.	Wt. Ea. Lbs.	Product Class
SM-1220	12" x 20 ft. Roll	Black	1	10.00	50LP
SM-1820	18" x 20 ft. Roll	Black	1	14.00	50LP
SM-2420	24" x 20 ft. Roll	Black	1	18.00	50LP
SM-3620	36" x 20 ft. Roll	Black	1	22.00	50LP

Recommended Installations

Surround Application:

Cut desired length of molded roll material. Connect the ends by overlapping two 6" sections with the leading rib cut directly down the middle. If using a sealant to seal the ends, utilize a dual-sided solvent-based tape (like that sold by Tuff Industries, Inc.). Install by placing the Sheet Material around root ball at a sufficient distance to allow proper backfill – the vertical integrated root-deflecting ribs should always be facing the root ball.

Linear/Root Pruning Application:

Cut desired length of molded roll material and install directly adjacent to hardscape being protected

ROOT BARRIER PLANTERS

Pre-molded, one piece, tapered root control planter made of Structural Foam High Impact Polyethylene (SFHIPP) for superior strength. The ribbed interior wall design guides tree roots down and out of the flanged base. Advantages include the elimination of measuring, cutting, gluing or assembly of panels. Installation is further simplified in that units fit into a 30" augured hole.

Specifications

Root Barrier Planter by NDS has a top diameter of 22", a bottom diameter of 30", a height of 18" and a wall thickness of 0.250". Planter is one piece and molded of up to 505 post consumer Structural Foam High Impact Polyethylene (SFHIPP) material with U.V. inhibitors. Root Barrier Planter has a 3/4" inward facing top edge, a 1" external facing ground anchoring base flange with 1/2" high raised vertical ribs at ± 6" intervals on the interior wall.

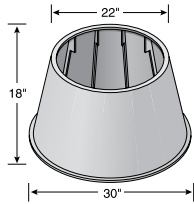

Part No.	Description	Color	Pkg. Qty.	Wt. Ea. Lbs.	Product Class
FI-15	Tapered Root Barrier Planter	Black	1	13.00	50LP

- A - Finished Grade
- B - 3" - 4" of 3/4" Gravel
- C - Amended Soil
- D - Sheet Material

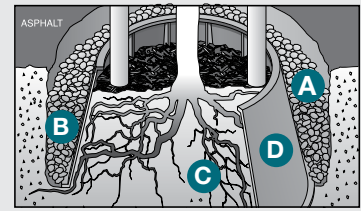

Recommended Installations

Patio Trees:

Root Barrier Planter is ideal for a 15 gallon tree or a 16" root ball whose trunk caliper will not exceed 14" in diameter at maturity.

Street Tree Use:

Root Barrier Planter is the preferred product for use in city sidewalk cutouts or where trees are completely surrounded by hardscape.

TRUNK PROTECTOR

Used around the base of trees to prevent damage from lawnmowers, edgers, and string trimmers. The coiled shape allows it to expand with the growth of the tree. It is vented, which permits the tree to breathe and it is notched at the base to accommodate root flare. NDS Trunk Protector is colored to help it blend with the natural shade of the tree. Each unit fits up to a 4" caliper tree; multiple units may be used for larger trees.

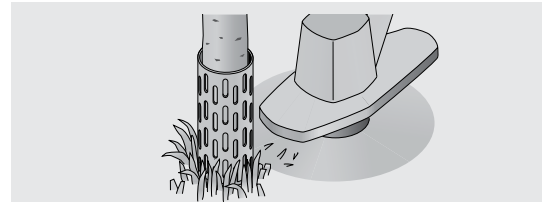

Specifications

Trunk Protector by NDS is made of Low Density linear Polyethylene (LDLPE) material with U.V. inhibitors to insure longevity. Trunk Protector measures 8" high, 12" wide and ± 0.050" thick. Slotted vents are 1" high by 1/4" wide, creating a serrated lower edge on the bottom row.

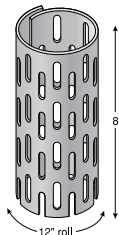

Part No.	Description	Color	Pkg. Qty.	Wt. Ea. Lbs.	Product Class
TP-128	Trunk Protector	Gray	50	0.16	50LP

Recommended Installations

Any tree planted in lawn or brush areas where mowing or trimming equipment may cause contact with tree trunks.

LANDSCAPE PRODUCTS INDEX

Part No.	Page	Part No.	Page	Part No.	Page	Part No.	Page
EP-1250	97	EP-3650	97	SM-1220	98	SM-3620	98
EP-1850	97	FI-15	99	SM-1820	98	TP-128	99
EP-2450	97	RP-4850	97	SM-2420	98		

NOTES

LANDSCAPE

PROFESSIONAL IRRIGATION

PROFESSIONAL IRRIGATION



Introducing NDS® Professional Irrigation, a line of efficient drip and micro-irrigation products that offers complete, system-oriented watering solutions for the green industry. Product offering includes drip emitters, multi-outlet bubblers, micro-sprays, misters, tubing, fittings, stakes, regulators, valves, and filters.

POINT OF CONNECTION

Hose Bib Timer



Part No.	Description	Color	Bag Qty./Box Qty.	Wt. Each (lbs.)	Product Class
A 675CT	Battery Hose Bib Timer	Blue	1/10	1.25	21DI
A 775CT	Battery Operated Digital Hose Bib Timer	Blue	1/12	1.5	21DI

Universal Conversion Kit & Cap Off

Patented



Part No.	Description	Color	Bag Qty./Box Qty.	Wt. per 100 (lbs.)	Product Class
FR2 17-710	Spray-to-Drip Conversion Kit 17mm-.710	Black	1	–	21DI
CAP POP/5	Universal Cap-Off	Black	5	–	21DI
CAP POP/25	Universal Cap-Off	Black	25	–	21DI

Pressure-Regulating Wye Filter



Part No.	Description	Color	Bag Qty./Box Qty.	Wt. per 100 (lbs.)	Product Class
PRYF 30	Pressure Regulating Filters, 3/4" MPT, 30 PSI, 200 mesh	Black	1/5	0.25	21DI
PRYF 40	Pressure Regulating Filters, 1" MPT, 40 PSI, 200 mesh	Black	1/5	0.30	21DI

Control Zone Kits



Part No.	Description	Bag Qty./Box Qty.	Wt. Each (lbs.)	Product Class
CZK 100-30F	1" Control Zone Kit with 30 PSI Pressure Regulating Filter and Flow Control	1/10	1.30	21DI
CZK 100-40F	1" Control Zone Kit with 40 PSI Pressure Regulating Filter and Flow Control	1/10	1.30	21DI
CZK 100-40VB1	1" Control Zone Kit with 40 PSI Pressure Regulating Filter in 10"x15" Green Valve Box	1/25	5.35	21DI

Drip Zone Kit

Part No.	Description	Bag Qty./Box Qty.	Wt. per 100 (lbs.)	Product Class
DZK 700/710	Drip Zone Kit: 150 Mesh Filter, 30 PSI Regulator, 1-8 gpm Flow (Fits .680" – .710" OD Tubing Outlet 1" and 3/4" MIPT Inlet)	1/10	0.76	21DI



Features	Benefits
All parts in one kit	No need to purchase or source additional parts
Easy installation	Saves time
Fits .680" – .710" OD PE Tubing	One kit used for a wide range of PE tubing, saving the need to have additional products
3/4" or 1" Inlet	Easily installed on 3/4" or 1" discharges
150 Mesh Filter	Prevents debris entering drip system
30 PSI Regulator	Will operate a wide range of micro products

POINT OF CONNECTION

Y Strainers



Part No.	Description	Color	Bag Qty./ Box Qty.	Wt. per 100 (lbs.)	Product Class
YS 75	"Y" Filter, 3/4" MIPT, with 150 Mesh Polyester Screen Element (10 gpm Capacity, 150 PSI Max. Pressure)	Black	1/50	33.1	21DI
YSV 75	"Y" Filter, 3/4" MIPT, with 150 Mesh Polyester Screen Element, Includes Flush Valve (10 gpm Capacity, 150 PSI Max. Pressure)	Black	1/50	35.6	21DI
YSVS 75	"Y" Filter, 3/4" MIPT, with 150 Mesh Stainless Steel Screen Element, Includes Flush Valve (10 gpm Capacity, 150 PSI Max. Pressure)	Black	1/50	36.5	21DI
YSS 100	"Y" Filter, 1" MIPT, with 150 Mesh Stainless Steel Screen Element, (10 gpm Capacity, 150 PSI Max. Pressure)	Black	1/50	36.8	21DI
YSV 100	"Y" Filter, 1" MIPT, with 150 Mesh Polyester Screen Element, Includes Flush Valve (10 gpm Capacity, 150 PSI Max. Pressure)	Black	1/50	39.0	21DI
YSVS 100	"Y" Filter, 1" MIPT, with 150 Mesh Stainless Steel Screen Element, Includes Flush Valve (10 gpm Capacity, 150 PSI Max. Pressure)	Black	1/50	39.7	21DI

PROFESSIONAL IRRIGATION

Pressure Regulators

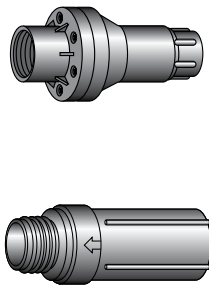

Part No.	Description	Color	Bag Qty./ Box Qty.	Wt. per 100 (lbs.)	Product Class
PR 20	20 PSI, 3/4" FIPT Pressure Regulator (0.1 – 8 gpm Flow Range)	Black	10/50	31.0	21DI
PR 30	30 PSI, 3/4" FIPT Pressure Regulator (0.1 – 8 gpm Flow Range)	Black	10/50	31.0	21DI
PRM 30	30 PSI, 3/4" FIPT Pressure Regulator (2 – 20 gpm Flow Range)	Black	10/50	31.0	21DI
PRP 20	20 PSI, Pipe Thread, Pressure Regulator (3/4" FPT in x 3/4" MPT out, .2 to 10 gpm)	Black	10/50	15.3	21DI
PRP 30	30 PSI, Pipe Thread, Pressure Regulator (3/4" FPT in x 3/4" MPT out, .2 to 10 gpm)	Grey	10/50	15.3	21DI

POINT OF CONNECTION

Pressure Regulators (continued)

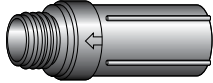

Part No.	Description	Color	Bag Qty./ Box Qty.	Wt. per 100 (lbs.)	Product Class
PRP 40	40 PSI, Pipe Thread, Pressure Regulator (3/4" FHT in x 3/4" MHT out, .2 to 10 gpm)	Blue	10/50	15.3	21DI
PRH 20	20 PSI, Hose Thread, Pressure Regulator (3/4" FHT in x 3/4" MHT out, .2 to 10 gpm)	Black	10/50	15.3	21DI
PRH 30	30 PSI, Hose Thread, Pressure Regulator (3/4" FHT in x 3/4" MHT out, .2 to 10 gpm)	Grey	10/50	15.3	21DI
PRH 40	40 PSI, Hose Thread, Pressure Regulator (3/4" FHT in x 3/4" MHT out, .2 to 10 gpm)	Blue	10/50	15.3	21DI

Swing Pipe Fittings



Part No.	Description	Color	Bag Qty./ Box Qty.	Wt. per 100 (lbs.)	Product Class
FPA-0500	1/2" Male MPT x Spiral Barbed Adapter	Black	50/500	1.6	42LS
FPA-0750	3/4" Male MPT x Spiral Barbed Adapter	Black	50/500	2.0	42LS
FPE-0500	1/2" Male MPT x Spiral Barbed Elbow	Black	50/500	2.2	42LS
FPE-0750	3/4" Male MPT x Spiral Barbed Elbow	Black	50/500	2.6	42LS
FPC-0490	1/2" Spiral Barbed Coupler	Black	50/500	1.4	42LS

Use with Super Flexee pipe. (See page 137)
Swing Riser Assemblies available. (See page 106)

POINT OF CONNECTION

Swing Joints

PVC Sch. 80
Swing Assembly
GRAY



PVC Sch. 40
Swing Assembly
WHITE



Part No.	Description	Color	Pkg. Qty.	Product Class	Specifications
PVC Sch. 80 Swing Assembly					
TSA-0500-BB	1/2" (BSP x BSP)	Gray	60	42TS	PVC Rated @ 315 PSI @ 72°F
TSA-0500-ST	1/2" S x M	Gray	60	42TS	
TSA-0500-TT	1/2" M x M	Gray	60	42TS	
TSA-0750-BB	3/4" (BSP x BSP)	Gray	50	42TS	
TSA-0750-CT	3/4" SCKT x MIPT	Gray	50	42TS	
TSA-0750-LT	3/4" LONG SPGT/MIPT	Gray	50	42TS	
TSA-0750-SC	3/4" S x S	Gray	50	42TS	
TSA-0750-ST	3/4" S x M	Gray	50	42TS	
TSA-0750-TT	3/4" M X M	Gray	50	42TS	
TSA-1000-BB	1" (BSP x BSP)	Gray	25	42TS	
TSA-1000-ST	1" S x M	Gray	25	42TS	
TSA-1000-TT	1" M x M	Gray	25	42TS	
TSA-1250-TT	1-1/4" M x M	Gray	15	42TS	
TSA-1500-SA	1-1/2" S x ACME	Gray	15	42TS	
TSA-1500-ST	1-1/2" S x M	Gray	15	42TS	
TSA-1500-TT	1-1/2" M x M	Gray	15	42TS	
TSA-1512-ST	1-1/2" X 1-1/4" SPIGOT x MIPT	Gray	15	42TS	
TSA-1512-TT	1-1/2" X 1-1/4" (MIPT x MIPT)	Gray	15	42TS	
PVC Sch. 40 Swing Assembly					
WSA-0500-TT	1/2" (T x T)	White	60	42TS	PVC Rated @ 315 PSI @ 72°F
WSA-0750-TT	3/4" (T x T)	White	50	42TS	
WSA-1000-TT	1" (T x T)	White	25	42TS	
WSA-1250-TT	1-1/4" (T x T)	White	25	42TS	

POINT OF CONNECTION

Landscape Sprinkler Products

	Part No.	Description	Ctn. Qty.	Product Class	Specifications
Cutoff Risers 	Cut-Off Risers				
	FCO-0500	1/2" x 6" Flex Cut-Off	50	42LS	Rated @ 70 PSI @ 72°F
	FCO-0750-R	1/2" x 3/4" x 6" MIPT x MIPT Flex-Cutoff	500	42LS	
	MCO-0500	1/2" x 6" MIPT x MIPT Multi-Cutoff	500	42LS	
	MCO-0500-12	1/2" x 12" MIPT x MIPT Multi-Cutoff	250	42LS	
	MCO-0750	3/4" x 6" MIPT x MIPT Multi-Cutoff	500	42LS	
	MCO-0750-R	1/2" x 3/4" x 6" MIPT x MIPT Multi-Cutoff	500	42LS	
Flex Risers 	Flex Risers				
	FR-0500-4	1/2" x 4" MIPT x MIPT Flex Riser	100	42LS	Rated @ 70 PSI @ 72°F
	FR-0500-4F	1/2" x 4" MPT x FPT Flex Riser	100	42LS	
	FR-0500-6	1/2" x 6" MIPT x MIPT Flex Riser	100	42LS	
	FR-0500-6F	1/2" x 6" MIPT x FIPT Flex Riser	100	42LS	
	FR-0750-6	3/4" x 6" MIPT x MIPT Flex Riser	50	42LS	
	FR-1000-7	1" x 7" MIPT x MIPT Flex Riser	25	42LS	
Cutoff Riser Extension 	Cutoff Riser Extension				
	CRE-0500-3	1/2" x 3" FIPT x MIPT Cutoff Riser Extension	200	42LS	Rated @ 70 PSI @ 72°F
	CRE-0750-4	3/4" x 4" FIPT x MIPT Cutoff Riser Extension	200	42LS	
Street Elbows 	Street Elbows				
	STL-0500	1/2" 90° FIPT x MIPT Street Elbow	1600	42LS	Rated @ 70 PSI @ 72°F
	STL-0750	3/4" 90° FIPT x MIPT Street Elbow	1000	42LS	
Swing Pipe Fittings 	Swing Pipe Fittings				
	FPA-0500	Swing Pipe Adapter .490BARB x 1/2"	50	42LS	
	FPA-0750	3/4" Swing Pipe Adapter	250	42LS	
	FPC-0490	.49" Swing Pipe Connector	250	42LS	
	FPE-0500	1/2" Swing Pipe Elbow	400	42LS	
	FPE-0500F	1/2" Swing Pipe Elbow FPT x Spiral Barb	400	42LS	
	FPE-0750	3/4" Swing Pipe Elbow	250	42LS	
	FPT-0500	1/2" Swing Pipe Tee	500	42LS	
Shrub Adapter 	Shrub Adapter				
	SAM-0500	1/2" Male Sprinkler Adapter	50	42LS	Rated @ 70 PSI @ 72°F

PROFESSIONAL IRRIGATION

Backwater Valves

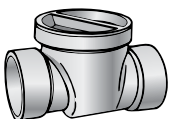

See list of products on pages 176-177.

DRIPLINE



- Reduces water use by 30% or more compared to overhead irrigation
- Complies with new water conservation legislation
- Highly efficient solution for landscape plantings & turfgrass
- Chemical-free root intrusion protection
- Longest run lengths in the industry
- Comprehensive offering from NDS Pressure Compensating, Non Pressure Compensating, Check Valve, Multiple Tubing size and color options

Dura Flo™ CV – One Dripline Tubing for All Applications

The new Dura Flo CV Check Valve Dripline combines the best of Dura Flo PC with a check valve. The combination brings the next level of water conservation to your irrigation project. The dripper features a check valve in combination with anti-siphon capabilities. The check valve prevents low emitter drainage on shut down and the anti-siphon feature eliminates back-siphonage at each emitter. This combination maximizes water efficiency by minimizing water loss and protecting each emitter from clogging and root intrusion. NDS Dura Flo CV is the only product offering this level of efficiency and protection in an all-in-one solution for drip line applications.

Features

PROFESSIONAL IRRIGATION



Check Valve

- Each emitter opens a 7.5 PSI – Longer run lengths lead to reduced material and labor costs
- Each emitter has a 2 PSI check valve that holds back up to 4.5 ft. of elevation – Prevents low head drainage & keeps the line full of water between irrigation intervals to provide instant watering when the system turns on for each cycle
- Reduces water waste – saves up to 1.39 gallons of water per 100 ft. of tubing



Anti-Siphon

- Each dripper is designed with an anti-siphon feature that prevents the suction of debris into the emitter
- Built-in anti-siphon feature eliminates the need for an air/vacuum relief valve

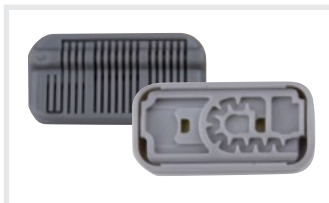

Emitter Specifications

- With its unique built-in filtration slits and self-cleaning design, clogging is minimized
- Flat, economical, check valve, pressure compensating, anti-siphon emitter maintains uniform flow rates at a wide range of working pressures and various topographies
- Operating range: 7.5 - 60 PSI
- Flow rates: 0.4 gph, 0.6 gph, and 0.9 gph
- Dripper spacing: 12", 18" or 24"



Pressure Compensation

- Conserves up to 70% of the water used by a conventional sprinkler irrigation system
- Distributes water evenly regardless of pressure fluctuations
- Self-flushing emitter eliminates debris from clogging the system during operation

Made in USA

DRIPLINE

17MM Dura Flo™ CV

Shrink Wrapped Packaging

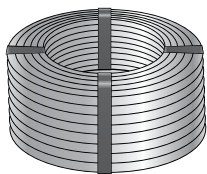

0.660" OD
Inline Check Valve

Part No.	Description	Color	Coil Size/Type	Wt. per 100' (lbs.)	Product Class
SFCV-BR-6212-01S	0.6 gph, 17mm Dura Flo™ Inline Check Valve Dripline (0.560" ID x 0.660" OD), 12" spacing	Brown	100'/ Wrapped Coil	3.3	21DF
SFCV-BR-6212-025S	0.6 gph, 17mm Dura Flo™ Inline Check Valve Dripline (0.560" ID x 0.660" OD), 12" spacing	Brown	250'/ Wrapped Coil	3.3	21DF
SFCV-BR-6212-05S	0.6 gph, 17mm Dura Flo™ Inline Check Valve Dripline (0.560" ID x 0.660" OD), 12" spacing	Brown	500'/ Wrapped Coil	3.3	21DF
SFCV-BR-6412-01S	0.9 gph, 17mm Dura Flo™ Inline Check Valve Dripline (0.560" ID x 0.660" OD), 12" spacing	Brown	100'/ Wrapped Coil	3.3	21DF
SFCV-BR-6412-025S	0.9 gph, 17mm Dura Flo™ Inline Check Valve Dripline (0.560" ID x 0.660" OD), 12" spacing	Brown	250'/ Wrapped Coil	3.3	21DF
SFCV-BR-6412-05S	0.9 gph, 17mm Dura Flo™ Inline Check Valve Dripline (0.560" ID x 0.660" OD), 12" spacing	Brown	500'/ Wrapped Coil	3.3	21DF
SFCV-BR-6418-01S	0.9 gph, 17mm Dura Flo™ Inline Check Valve Dripline (0.560" ID x 0.660" OD), 18" spacing	Brown	100'/ Wrapped Coil	3.3	21DF
SFCV-BR-6418-025S	0.9 gph, 17mm Dura Flo™ Inline Check Valve Dripline (0.560" ID x 0.660" OD), 18" spacing	Brown	250'/ Wrapped Coil	3.3	21DF
SFCV-BR-6418-05S	0.9 gph, 17mm Dura Flo™ Inline Check Valve Dripline (0.560" ID x 0.660" OD), 18" spacing	Brown	500'/ Wrapped Coil	3.3	21DF
SFCV-BR-6424-05S	0.9 gph, 17mm Dura Flo™ Inline Check Valve Dripline (0.560" ID x 0.660" OD), 24" spacing	Brown	500'/ Wrapped Coil	3.3	21DF

Notes: 1,000' Coils are Available Made to Order.

Brown 17mm Tubing with no emitters can be found on page 136 – See A660BR SKUs.

DRIPLINE

17MM Dura Flo™ PC

Shrink Wrapped
Packaging



PROFESSIONAL IRRIGATION



0.660" OD
Pressure Compensative

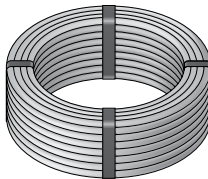

0.660" OD
Pressure Compensative

Part No.	Description	Color	Coil Size/Type	Wt. per 100' (lbs.)	Product Class
SFPC-BR-17212-01S	1/2 gph, 17mm Dura Flo™ Pressure Compensating Dripline (0.560" ID x 0.660" OD), 12" spacing	Brown	100'/ Wrapped Coil	4.1	21DF
SFPC-BR-17212-025S	1/2 gph, 17mm Dura Flo™ Pressure Compensating Dripline (0.560" ID x 0.660" OD), 12" spacing	Brown	250'/ Wrapped Coil	4.1	21DF
SFPC-BR-17212-05S	1/2 gph, 17mm Dura Flo™ Pressure Compensating Dripline (0.560" ID x 0.660" OD), 12" spacing	Brown	500'/ Wrapped Coil	4.1	21DF
SFPC-BR-17218-01S	1/2 gph, 17mm Dura Flo™ Pressure Compensating Dripline (0.560" ID x 0.660" OD), 18" spacing	Brown	100'/ Wrapped Coil	3.9	21DF
SFPC-BR-17218-025S	1/2 gph, 17mm Dura Flo™ Pressure Compensating Dripline (0.560" ID x 0.660" OD), 18" spacing	Brown	250'/ Wrapped Coil	3.9	21DF
SFPC-BR-17218-05S	1/2 gph, 17mm Dura Flo™ Pressure Compensating Dripline (0.560" ID x 0.660" OD), 18" spacing	Brown	500'/ Wrapped Coil	3.9	21DF
SFPC-BR-17412-025S	1 gph, 17mm Dura Flo™ Pressure Compensating Dripline (0.560" ID x 0.660" OD), 12" spacing	Brown	250'/ Wrapped Coil	4.1	21DF
SFPC-BR-17412-05S	1 gph, 17mm Dura Flo™ Pressure Compensating Dripline (0.560" ID x 0.660" OD), 12" spacing	Brown	500'/ Wrapped Coil	4.1	21DF
SFPC-PS-17412-05S	1 gph, 17mm Dura Flo™ Pressure Compensating Dripline (0.560" ID x 0.660" OD), 12" spacing	Brown/ Purple Stripe	500'/ Wrapped Coil	4.1	21DF
SFPC-RC-17412-05S	1 gph, 17mm Dura Flo™ Pressure Compensating Dripline (0.560" ID x 0.660" OD), 12" spacing	Purple	500'/ Wrapped Coil	4.1	21DF
SFPC-BR-17412-10	1 gph, 17mm Dura Flo™ Pressure Compensating Dripline (0.560" ID x 0.660" OD), 12" spacing	Brown	1,000'/ Wrapped Coil	3.8	21DF

Note: 1,000' Coils are Available Made to Order.

DRIPLINE

16MM Dura Flo™ PC



0.640" OD
Pressure Compensative

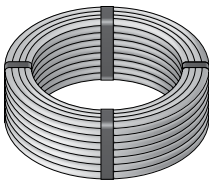

0.640" OD
Pressure Compensative

Part No.	Description	Color	Coil Size/Type	Wt. per 100' (lbs.)	Product Class
SFPC-BR-6212-025	1/2 gph, 16mm Dura Flo™ Pressure Compensating Dripline (0.550" ID x 0.640" OD), 12" spacing	Brown	250'/Coil	4.0	21DF
SFPC-BR-6212-05	1/2 gph, 16mm Dura Flo™ Pressure Compensating Dripline (0.550" ID x 0.640" OD), 12" spacing	Brown	500'/Coil	4.0	21DF
SFPC-BL-6412-01	1 gph, 16mm Dura Flo™ Pressure Compensating Dripline (0.550" ID x 0.640" OD), 12" spacing	Black	100'/Coil	4.0	21DF
SFPC-BR-6412-01	1 gph, 16mm Dura Flo™ Pressure Compensating Dripline (0.550" ID x 0.640" OD), 12" spacing	Brown	100'/Coil	4.0	21DF
SFPC-BR-6412-025	1 gph, 16mm Dura Flo™ Pressure Compensating Dripline (0.550" ID x 0.640" OD), 12" spacing	Brown	250'/Coil	4.0	21DF
SFPC-BR-6412-05	1 gph, 16mm Dura Flo™ Pressure Compensating Dripline (0.550" ID x 0.640" OD), 12" spacing	Brown	500'/Coil	4.0	21DF
SFPC-BR-6418-01	1 gph, 16mm Dura Flo™ Pressure Compensating Dripline (0.550" ID x 0.640" OD), 18" spacing	Brown	100'/Coil	3.8	21DF
SFPC-BR-6418-025	1 gph, 16mm Dura Flo™ Pressure Compensating Dripline (0.550" ID x 0.640" OD), 18" spacing	Brown	250'/Coil	3.8	21DF
SFPC-BL-6418-05	1 gph, 16mm Dura Flo™ Pressure Compensating Dripline (0.550" ID x 0.640" OD), 18" spacing	Black	500'/Coil	3.8	21DF
SFPC-BR-6418-05	1 gph, 16mm Dura Flo™ Pressure Compensating Dripline (0.550" ID x 0.640" OD), 18" spacing	Brown	500'/Coil	3.8	21DF

PROFESSIONAL IRRIGATION

DRIPLINE

18MM Dura Flo™ PC



0.700" OD
Pressure Compensative

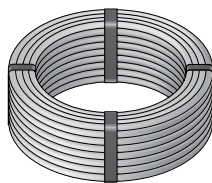

0.700" OD
Pressure Compensative

Part No.	Description	Color	Coil Size/Type	Wt. per 100' (lbs.)	Product Class
SFPC-BL-7212-01	1/2 gph, 18mm Dura Flo™ Pressure Compensating Dripline (0.600" ID x 0.700" OD), 12" spacing	Black	100'/Coil	4.7	21DF
SFPC-BR-7212-01	1/2 gph, 18mm Dura Flo™ Pressure Compensating Dripline (0.600" ID x 0.700" OD), 12" spacing	Brown	100'/Coil	4.7	21DF
SFPC-BL-7212-05	1/2 gph, 18mm Dura Flo™ Pressure Compensating Dripline (0.600" ID x 0.700" OD), 12" spacing	Black	500'/Coil	4.7	21DF
SFPC-BR-7218-05	1/2 gph, 18mm Dura Flo™ Pressure Compensating Dripline (0.600" ID x 0.700" OD), 18" spacing	Brown	500'/Coil	4.5	21DF
SFPC-BL-7412-01	1 gph, 18mm Dura Flo™ Pressure Compensating Dripline (0.600" ID x 0.700" OD), 12" spacing	Black	100'/Coil	4.7	21DF
SFPC-BR-7412-01	1 gph, 18mm Dura Flo™ Pressure Compensating Dripline (0.600" ID x 0.700" OD), 12" spacing	Brown	100'/Coil	4.7	21DF
SFPC-BL-7412-05	1 gph, 18mm Dura Flo™ Pressure Compensating Dripline (0.600" ID x 0.700" OD), 12" spacing	Black	500'/Coil	4.7	21DF
SFPC-BR-7412-05	1 gph, 18mm Dura Flo™ Pressure Compensating Dripline (0.600" ID x 0.700" OD), 12" spacing	Brown	500'/Coil	4.7	21DF
SFPC-BL-7418-05	1 gph, 18mm Dura Flo™ Pressure Compensating Dripline (0.600" ID x 0.700" OD), 18" spacing	Black	500'/Coil	4.5	21DF
SFPC-BR-7418-05	1 gph, 18mm Dura Flo™ Pressure Compensating Dripline (0.600" ID x 0.700" OD), 18" spacing	Brown	500'/Coil	4.5	21DF

18MM Dura Flo™ CV

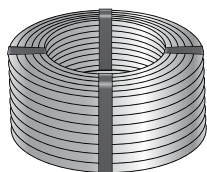

0.700" OD
Inline Check Valve

Part No.	Description	Color	Coil Size/Type	Wt. per 100' (lbs.)	Product Class
SFCV-BR-7212-01	0.6 gph, 18mm Dura Flo™ Inline Check Valve Dripline (0.600" ID x 0.700" OD), 12" spacing	Brown	100'/Coil	3.3	21DF
SFCV-BR-7412-01	0.9 gph, 18mm Dura Flo™ Inline Check Valve Dripline (0.600" ID x 0.700" OD), 12" spacing	Brown	100'/Coil	3.3	21DF
SFCV-BR-7412-025	0.9 gph, 18mm Dura Flo™ Inline Check Valve Dripline (0.600" ID x 0.700" OD), 12" spacing	Brown	250'/Coil	3.3	21DF
SFCV-BR-7412-10	0.9 gph, 18mm Dura Flo™ Inline Check Valve Dripline (0.600" ID x 0.700" OD), 12" spacing	Brown	1,000'/Coil	3.3	21DF
SFCV-BR-7218-01	0.9 gph, 18mm Dura Flo™ Inline Check Valve Dripline (0.600" ID x 0.700" OD), 18" spacing	Brown	100'/Coil	3.3	21DF
SFCV-BR-7218-025	0.9 gph, 18mm Dura Flo™ Inline Check Valve Dripline (0.600" ID x 0.700" OD), 18" spacing	Brown	250'/Coil	3.3	21DF

DRIPLINE – TECHNICAL INFORMATION

17MM Dura Flo™ CV Maximum Recommended Length of Run (Feet)

Initial Pressure	12" SPACING			18" SPACING			24" SPACING		
	0.4 GPH	0.6 GPH	0.9 GPH	0.4 GPH	0.6 GPH	0.9 GPH	0.4 GPH	0.6 GPH	0.9 GPH
15 PSI	261'	221'	161'	347'	292'	214'	420'	354'	260'
20 PSI	357'	300'	221'	477'	399'	294'	576'	488'	358'
25 PSI	422'	354'	259'	563'	471'	346'	684'	575'	421'
30 PSI	471'	395'	289'	629'	526'	385'	765'	642'	471'
35 PSI	514'	429'	314'	687'	571'	418'	835'	699'	512'
40 PSI	550'	460'	336'	735'	618'	449'	893'	748'	549'
45 PSI	582'	486'	355'	779'	650'	473'	947'	791'	581'
50 PSI	610'	508'	372'	818'	677'	493'	995'	830'	610'

Discharge Rates (GPH)

Model	Part No.	10 PSI	15 PSI	20 PSI	25 PSI	30 PSI	40 PSI	60 PSI	80 PSI
Dura Flo™ JR Mini Dripplerline	DS 20			1.7 gph	1.9 gph	2.0 gph	2.2 gph	2.5 gph	2.1 gph
	DS 30			3.0 gph	3.3 gph	3.6 gph	3.6 gph	3.6 gph	3.0 gph
Dura Flo™ PC Dripplerline	SFJR-XX-XX-XX	0.39 gph	0.47 gph	0.56 gph	0.63 gph	0.69 gph			
	SFPC-XX-62XX-XX	0.45 gph	0.50 gph	0.50 gph	0.50 gph	0.50 gph	0.50 gph	0.45 gph	
	SFPC-XX-64XX-XX	0.75 gph	0.90 gph	0.90 gph	0.90 gph	0.90 gph	0.85 gph	0.80 gph	
	SFPC-XX-68XX-XX	1.40 gph	1.60 gph	1.65 gph	1.65 gph	1.65 gph	1.65 gph	1.65 gph	
	SFPC-XX-72XX-XX	0.50 gph	0.55 gph	0.55 gph	0.55 gph	0.55 gph	0.55 gph	0.50 gph	
	SFPC-XX-74XX-XX	0.80 gph	0.95 gph	0.95 gph	0.95 gph	0.95 gph	0.95 gph	0.85 gph	
	SFPC-XX-78XX-XX	1.50 gph	1.75 gph	1.80 gph	1.80 gph	1.80 gph	1.80 gph	1.80 gph	
Dura Flo™ Dripplerline	SFPC-XX-204XX-XX	0.43 gph	0.45 gph	0.48 gph	0.48 gph	0.49 gph	0.49 gph	0.45 gph	
	SFPC-XX-208XX-XX	0.80 gph	0.83 gph	0.83 gph	0.86 gph	0.88 gph	0.93 gph	0.94 gph	
	SF-XX-62XX-XX	1.55 gph	1.62 gph	1.62 gph	1.65 gph	1.65 gph	1.62 gph	1.77 gph	
	SF-XX-64XX-XX	0.36 gph	0.40 gph	0.51 gph	0.60 gph	0.68 gph	0.78 gph		
	SF-XX-68XX-XX	0.63 gph	0.78 gph	0.92 gph	1.08 gph	1.21 gph	1.41 gph		
Mini Flo™ Emitter	SF-XX-72XX-XX	1.26 gph	1.58 gph	1.79 gph	2.00 gph	2.20 gph	2.54 gph		
	SF-XX-74XX-XX	0.40 gph	0.48 gph	0.56 gph	0.66 gph	0.75 gph	0.86 gph		
	SF-XX-78XX-XX	0.71 gph	0.86 gph	1.01 gph	1.19 gph	1.35 gph	1.56 gph		

PROFESSIONAL IRRIGATION

Maximum Recommended Length of Run (Feet)

Model	Nominal Flow Rate	Initial Pressure	I.D. of Tubing (inches)									
			.520"	.600"	.520"	.600"	.520"	.600"	.520"	.600"	.520"	.600"
			Spacing Between Emitters (inches)									
		18"		24"		36"		48"		60"		
PC Plus™ Emitter	0.5 gph	20 PSI	350'	440'	415'	535'	530'	68'	640'	820'	740'	970'
		30 PSI	460'	590'	550'	710'	700'	900'	850'	1,090'	1,000'	1,290'
		40 PSI	540'	695'	640'	825'	840'	1,080'	1,020'	1,310'	1,160'	1,500'
	1.0 gph	20 PSI	220'	280'	265'	340'	340'	440'	410'	530'	480'	620'
		30 PSI	290'	375'	350'	450'	450'	580'	540'	690'	630'	820'
		40 PSI	340'	440'	410'	530'	540'	690'	650'	840'	750'	965'
	2.0 gph	20 PSI	160'	200'	190'	240'	240'	305'	300'	370'	350'	435'
		30 PSI	210'	265'	255'	320'	325'	405'	390'	490'	460'	575'
		40 PSI	250'	310'	300'	370'	380'	475'	460'	575'	540'	675'

DRIPLINE – TECHNICAL INFORMATION

Maximum Recommended Length of Run (Feet)

Model	Nominal Flow Rate	Initial Pressure	Spacing Between Emitters (inches)																	
			12"			18"			24"			36"			48"			60"		
			Tubing Size																	
			.630" OD	.710" OD	.830" OD	.630" OD	.710" OD	.830" OD	.630" OD	.710" OD	.830" OD	.630" OD	.710" OD	.830" OD	.630" OD	.710" OD	.830" OD	.630" OD	.710" OD	.830" OD
Dura Flo™ Emitter-line	0.5 gph	20 PSI	180'	240'	N/A	250'	340'	N/A	300'	420'	N/A	400'	550'	N/A	490'	680'	N/A	570'	790'	N/A
	1.0 gph	20 PSI	130'	180'	N/A	170'	240'	N/A	210'	300'	N/A	270'	390'	N/A	340'	480'	N/A	390'	550'	N/A
	2.0 gph	20 PSI	95'	120'	N/A	125'	150'	N/A	150'	190'	N/A	200'	250'	N/A	250'	310'	N/A	285'	360'	N/A
Dura Flow PCT™ Emitter-line	0.5 gph		.640" OD	.700" OD	.830" OD	.640" OD	.700" OD	.830" OD	.640" OD	.700" OD	.830" OD	.640" OD	.700" OD	.830" OD	.640" OD	.700" OD	.830" OD	.640" OD	.700" OD	.830" OD
		15 PSI	180'	210'	315'	255'	300'	495'	325'	380'	560'	455'	525'	780'	560'	650'	950'	655'	760'	1,090'
		25 PSI	265'	315'	460'	380'	450'	660'	485'	570'	825'	675'	780'	1,160'	850'	975'	1,420'	990'	1,140'	1,630'
		35 PSI	325'	380'	565'	460'	540'	790'	580'	685'	990'	810'	940'	1,400'	1,020'	1,175'	1,700'	1,190'	1,375'	1,950'
	45 PSI	365'	430'	625'	520'	610'	890'	660'	775'	1,120'	920'	1,065'	1,580'	1,150'	1,330'	1,930'	1,345'	1,555'	2,200'	
	1.0 gph	15 PSI	130'	155'	215'	185'	220'	315'	240'	280'	380'	330'	380'	540'	410'	475'	660'	480'	555'	755'
		25 PSI	195'	230'	330'	280'	330'	460'	355'	420'	575'	485'	570'	840'	615'	715'	970'	720'	835'	1,080'
		35 PSI	240'	280'	395'	335'	395'	560'	430'	505'	690'	585'	690'	970'	740'	860'	1,190'	865'	1,005'	1,360'
		45 PSI	265'	315'	445'	380'	450'	625'	485'	570'	775'	660'	780'	1,100'	835'	975'	1,335'	975'	1,140'	1,530'
	2.0 gph	15 PSI	85'	100'	150'	125'	145'	200'	155'	180'	250'	215'	245'	350'	260'	305'	430'	300'	355'	495'
		25 PSI	125'	150'	215'	180'	215'	300'	230'	270'	380'	315'	365'	520'	400'	455'	640'	470'	530'	730'
		35 PSI	150'	180'	265'	215'	255'	330'	270'	320'	460'	380'	440'	635'	480'	550'	775'	560'	645'	890'
		45 PSI	170'	200'	295'	250'	290'	410'	305'	360'	510'	430'	500'	715'	540'	625'	875'	630'	730'	1,000'

PROFESSIONAL IRRIGATION

Model	Nominal Flow Rate	Initial Pressure	Spacing Between Emitters (inches)				
			12"	18"	24"	30"	36"
Mini Flo™ Emitter	0.5 gph	20 PSI	20'	25'	30'	35'	40'
	1.0 gph	20 PSI	12'	15'	18'	21'	24'

Model	Nominal Flow Rate	Spacing	Maximum Run	Model	Nominal Flow Rate	Spacing	Maximum Run
Dura Flo™ JR Mini Dripperline	0.5 gph	6"	19 ft.	Laser Drilled Soaker Hose (1/4")	1.0 gph	6"	12 ft.
	0.5 gph	12"	33 ft.		1.0 gph	12"	20 ft.

Calculations are based on: 1. No elevation changes over length of run. 2. Maximum allowable variation in discharge rate of ±7.5%.

Refer to Technical Specifications Document for Flowcharts and Run Length Information at ndspro.com/specifications

DRIPLINE – TECHNICAL INFORMATION

The Following Formula Should be Used to Calculate Application Rates

$$\text{Application Rate (inches per hour)} = \frac{231 \times \text{Emitter Flow Rates (gph)}}{\text{Spacing between Poly Laterals (inches)} \times \text{Spacing between Emission Device (inches)}}$$

(A)
(B)

Example

Emitter Flow Rate = 1 gph

Spacing between Emission Device = 18"

Spacing between Poly Laterals = 16"

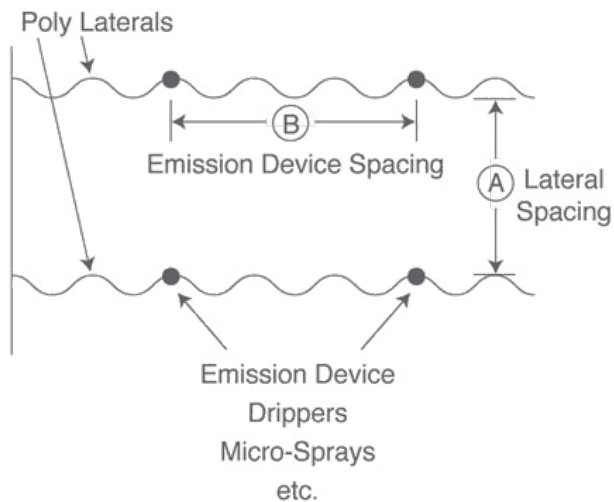

Question

What is the application rate?

Solution

$$\text{Application Rate} = \frac{231 \times 1}{16 \times 18} = 0.80\text{"/hr}$$

Drip Application Rates (Inches/Hour) – Based on Nominal Flow Rates

Emitter Spacing	1/2 gph										
	Spacing between Poly Laterals										
	12"	13"	14"	15"	16"	17"	18"	19"	20"	22"	24"
12"	.80	.74	.69	.64	.60	.57	.53	.51	.48	.44	.40
18"	.53	.49	.46	.43	.40	.38	.36	.34	.32	.29	.27
24"	.40	.37	.34	.32	.30	.28	.26	.25	.24	.22	.20

Emitter Spacing	1 gph										
	Spacing between Poly Laterals										
	12"	13"	14"	15"	16"	17"	18"	19"	20"	22"	24"
12"	1.60	1.48	1.38	1.28	1.20	1.14	1.06	1.02	.96	.88	.80
18"	1.07	.99	.92	.86	.80	.75	.71	.68	.64	.58	.53
24"	.80	.74	.69	.64	.60	.57	.53	.51	.48	.44	.40

Emitter Spacing	2 gph										
	Spacing between Poly Laterals										
	12"	13"	14"	15"	16"	17"	18"	19"	20"	22"	24"
12"	3.20	2.96	2.75	2.56	2.40	2.28	2.12	2.04	1.92	1.76	1.60
18"	2.14	1.98	1.84	1.72	1.60	1.50	1.42	1.36	1.28	1.16	1.06
24"	1.60	1.48	1.38	1.28	1.20	1.14	1.06	1.02	.96	.88	.80

SINGLE-OUTLET DEVICES

Pressure Compensating

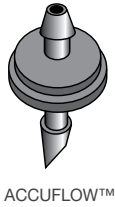

Part No.	Description	Color	Bag Qty./ Box Qty.	Wt. per 100 (lbs.)	Product Class
AccuFlow™					
AFPC 5	1/2 gph Pressure Compensating AccuFlow™ Emitter	Blue	100/N/A	N/A	21DI
AFPC 5/1000	1/2 gph Pressure Compensating AccuFlow™ Emitter	Blue	1,000/N/A	N/A	21DI
AFPC 10	1 gph Pressure Compensating AccuFlow™ Emitter	Black	100/N/A	N/A	21DI
AFPC 20	2 gph Pressure Compensating AccuFlow™ Emitter	Red	100/N/A	N/A	21DI
AFPC 20/25	2 gph Pressure Compensating AccuFlow™ Emitter	Red	25/N/A	N/A	21DI
AFPC 50	5 gph Pressure Compensating AccuFlow™ Emitter	Tan	100/N/A	N/A	21DI
AFPC 50/1000	5 gph Pressure Compensating AccuFlow™ Emitter	Tan	1,000/N/A	N/A	21DI

Non-Pressure Compensating

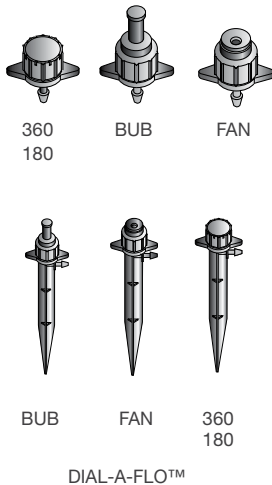

Part No.	Description	Color	Bag Qty./ Box Qty.	Wt. per 100 (lbs.)	Product Class
Dial-a-Flo™					
DAFB 360	360°, 8 Stream, 0-10 gph, 1/4" Barbed, Adjustable Dial-a-Flo™ Emitter	Black	100/2,500	0.5	21DI
DAFB 180	180°, 5 Stream, 0-10 gph, 1/4" Barbed, Adjustable Dial-a-Flo™ Emitter	Black	100/2,500	0.5	21DI
DAFB FAN	360°, Fan Spray, 0-20 gph, 1/4" Barbed, Adjustable Dial-a-Flo™ Emitter	Black	100/2,500	0.6	21DI
DAFB BUB	Umbrella Bubbler, 0-25 gph, 1/4" Barbed, Adjustable Dial-a-Flo™ Emitter	Black	100/2,500	0.7	21DI
DAFT 360	360°, 8 Stream, 0-10 gph, 10/32 NDS Threads, Adjustable Dial-a-Flo™ Emitter	Black	100/2,500	0.6	21DI
DAFT 180	180°, 5 Stream, 0-10 gph, 10/32 NDS Threads, Adjustable Dial-a-Flo™ Emitter	Black	100/2,500	0.6	21DI
DAFT FAN	360°, Fan Spray, 0-20 gph, 10/32 NDS Threads, Adjustable Dial-a-Flo™ Emitter	Black	100/2,500	0.7	21DI
DAFT BUB	Umbrella Bubbler, 0-25 gph, 10/32 NDS Threads, Adjustable Dial-a-Flo™ Emitter	Black	100/2,500	0.8	21DI
DAFS 360	360°, 8 Stream, 0-10 gph, Adjustable Dial-a-Flo™ Emitter with 6" Stake	Black	100/1,000	1.4	21DI
DAFS 180	180°, 5 Stream, 0-10 gph, Adjustable Dial-a-Flo™ Emitter with 6" Stake	Black	100/1,000	1.4	21DI
DAFS FAN	360°, Fan Spray, 0-20 gph, Adjustable Dial-a-Flo™ Emitter with 6" Stake	Black	100/1,000	1.4	21DI
DAFS BUB	Umbrella Bubbler, 0-25 gph, Adjustable Dial-a-Flo™ Emitter with 6" Stake	Black	100/1,000	1.5	21DI

SINGLE-OUTLET DEVICES

Non-Pressure Compensating (continued)



SUPER-FLO™

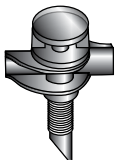
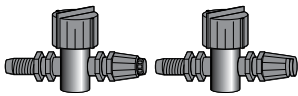

HYDRO-FLO™

Part No.	Description	Color	Bag Qty./ Box Qty.	Wt. per 100 (lbs.)	Product Class
Super-Flo™					
TAE 10	1 gph, Laminar Flow, Take-Apart Super-Flo™ Emitter	Black	100/2,000	0.4	21DI
TAE 20	2 gph, Laminar Flow, Take-Apart Super-Flo™ Emitter	Green	100/2,000	0.4	21DI
TAE 40	4 gph, Laminar Flow, Take-Apart Super-Flo™ Emitter	Yellow	100/2,000	0.4	21DI
Hydro-Flo™					
VF 360	0-25 gph, Hydro-Flo™ Adjustable Jet (360° Pattern – Stream Spray, 10-32 NPT Inlet)*	Black	100/500	0.5	21DI
VF 180	0-25 gph, Hydro-Flo™ Adjustable Jet (180° Pattern – Fan Spray, 10-32 NPT Inlet)*	Black	100/500	0.5	21DI
VF 90	0-25 gph, Hydro-Flo™ Adjustable Jet (90° Pattern – Fan Spray, 10-32 NPT Inlet)*	Black	100/500	0.5	21DI
*Uses SAJ Adapter (page 117)					
TF 436	0.040" Nozzle, 360° Fan Spray Single-Piece Hydro-Flo™ Jet	Blue	100/2,500	0.1	21DI
TF 536	0.050" Nozzle, 360° Fan Spray Single-Piece Hydro-Flo™ Jet	Green	100/2,500	0.1	21DI
TF 636	0.060" Nozzle, 360° Fan Spray Single-Piece Hydro-Flo™ Jet	Red	100/2,500	0.1	21DI
TF 418	0.040" Nozzle, 180° Fan Spray Single-Piece Hydro-Flo™ Jet	Blue	100/2,500	0.1	21DI
TF 518	0.050" Nozzle, 180° Fan Spray Single-Piece Hydro-Flo™ Jet	Green	100/2,500	0.1	21DI
TF 618	0.060" Nozzle, 180° Fan Spray Single-Piece Hydro-Flo™ Jet	Red	100/2,500	0.1	21DI
TF 49	0.040" Nozzle, 90° Fan Spray Single-Piece Hydro-Flo™ Jet	Blue	100/2,500	0.1	21DI
TF 59	0.050" Nozzle, 90° Fan Spray Single-Piece Hydro-Flo™ Jet	Green	100/2,500	0.1	21DI
TF 69	0.060" Nozzle, 90° Fan Spray Single-Piece Hydro-Flo™ Jet	Red	100/2,500	0.1	21DI

PROFESSIONAL IRRIGATION

RootWise™

ROOTWISE™

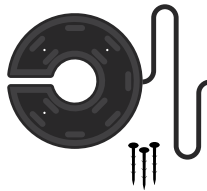

Part No.	Description	Color	Bag Qty./ Box Qty.	Product Class
RootWise™				
RW16N1	16" Diameter 360° Watering Pad	Black	1/8	21DI
RW16N6	16" Diameter 360° Watering Pad	Black	6/8	21DI

SINGLE-OUTLET DEVICES

Non-Pressure Compensating



MICRO-FLO™



TRI-FLO™

Part No.	Description	Color	Bag Qty./ Box Qty.	Wt. per 100 (lbs.)	Product Class
Micro-Flo™					
MFA	0-25 gph, Micro-Flo™ Adjustable Micro-Sprinkler with Shutoff (10-32 NPT Inlet)*	Red	50/300	1.2	21DI
*Uses SAJ Adapter (page 117)					
Tri-Flo™					
TFS 9	3 Flow Tri-Flo™ Spraystick, 90° Pattern	Blue	100/2,000	0.6	21DI
TFS 16	3 Flow Tri-Flo™ Spraystick, 160° Pattern	Green	100/2,000	0.7	21DI
Use with 1/8" tubing A 185 (page 135). Not recommended for vinyl tubing.					

Risers & Accessories

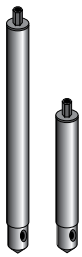

HYDRO-POP™

Part No.	Description	Color	Bag Qty./ Box Qty.	Wt. per 100 (lbs.)	Product Class
Hydro-Pop™					
HYP 250	Hydro-Pop™ Pop-up Riser with 1/4" Compression Fit Inlet Maximum 9" Extension (Minimum Pressure Required = 15 PSI)	Black	25/100	12.9	21DI
HYPJ 250	Hydro-Pop™ Pop-up Riser with 1/4" Compression Fit Inlet Maximum 5" Extension (Minimum Pressure Required = 15 PSI)	Black	25/150	9.7	21DI

SINGLE-OUTLET DEVICES

Risers & Accessories (continued)



Part No.	Description	Color	Bag Qty./ Box Qty.	Wt. per 100 (lbs.)	Product Class
R 12	12" Riser Extension (0.160" ID x 0.300" OD)	Black	100/1,000	2.1	21DI
RATT 12	12" Riser (0.160" ID) with Threaded Adapter	Black	100/1,000	2.2	21DI
RABB 8	8" Riser (.160" ID) with Barbed Adapter	Black	100/N/A	1.5	21DI
RABT 12	12" Riser (0.160" ID) with Barbed Adapter	Black	100/1,000	2.2	21DI
S5R6	6" Riser (R6) Pre-assembled onto Elbow Stake (S5)	Black	100/400	2.5	21DI
S5R8	8" Riser (R8) Pre-assembled onto Elbow Stake (S5)	Black	100/400	2.8	21DI
S5R12	12" Riser (R12) Pre-assembled onto Elbow Stake (S5)	Black	100/600	3.6	21DI
CMAP 6	6" Riser Assembly (1/2" MIPT x 0.160" ID/0.300" OD PE Tubing)	Black	100/200	2.8	21DI
CMAP 12	12" Riser Assembly (1/2" MIPT x 0.160" ID/0.300" OD PE Tubing)	Black	100/200	3.6	21DI

Stake Assemblies

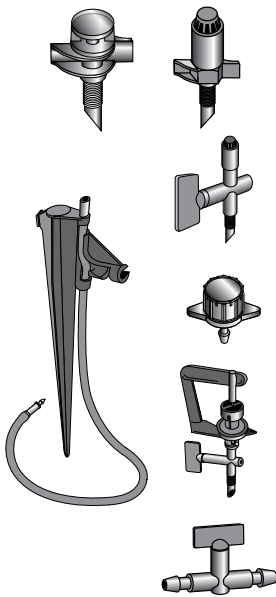

Part No.	Description	Color	Bag Qty./ Box Qty.	Wt. per 100 (lbs.)	Product Class
TA 24-1XY	Jet Assembly Comprising 2-Piece Hydro-Flo™ Jet, 24" Vinyl Tubing with Connector and S 12 Stake X=F (For 360°). H (For 180°). Q (For 90°) Y=3 (Black Base). 4 (Blue Base). 5 (Green Base) 6 (Red Base). 7 (White Base)	Specify	N/A/200	10.9	21DI
TA 24-2XY	Jet Assembly Comprising 1-Piece Hydro-Flo™ Jet, 24" Vinyl Tubing with Connector and S 12 Stake X=F (For 360°). H (For 180°). Q (For 90°) Y=3 (Black Orifice). 4 (Blue Orifice). 5 (Green Orifice) 6 (Green Orifice). 7 (Red Orifice)	Specify	N/A/200	10.8	21DI
TA 24-3X	Jet Assembly Comprising Adjustable Hydro-Flo™ Jet, 24" Vinyl Tubing with Connector and S 12 Stake X=F (For 360°). H (For 180°). Q (For 90°)	Black	N/A/200	11.2	21DI
TA 24-4	Assembly Comprising 24" Vinyl Tubing, Connector and S 12 Stake (No Jet)	Black	N/A/200	10.7	21DI
TA 24-5	Emitter Assembly Comprising Dial-a-Flo™ (DAFB 360), 24" Vinyl Tubing with Connector and S 12 Stake	Black	N/A/200	11.2	21DI
TA 24-6	Jet Assembly Comprising Adjustable Micro-Flo™ Sprinkler (MFA), 24" Vinyl Tubing with Connector and S 12 Stake	Black	N/A/200	11.9	21DI
TA 24-7	Assembly Comprising 24" Vinyl Tubing with Connector, Valve for Flow Adjustment and S 12 Stake	Black	N/A/200	11.1	21DI

MULTI-OUTLET DEVICES

Fixed Flow Rate Devices



CUATRO-FLO™

Part No.	Description	Color	Bag Qty./ Box Qty.	Wt. per 100 (lbs.)	Product Class
Cuatro-Flo™					
CFL 2	2 gph/Outlet Bubbler, 4 Swivel Barbed Outlets 1/2" FIPT, Pressure Compensating Cuatro-Flo™ Bubbler	Blue	25/100	5.5	21DI
CFL 6	6 gph/Outlet Bubbler, 4 Swivel Barbed Outlets 1/2" FIPT, Pressure Compensating Cuatro-Flo™ Bubbler	Black	25/100	5.5	21DI
CFL 10	10 gph/Outlet Bubbler, 4 Swivel Barbed Outlets 1/2" FIPT, Pressure Compensating Cuatro-Flo™ Bubbler	Red	25/100	5.5	21DI
CFL 20	20 gph/Outlet Bubbler, 4 Swivel Barbed Outlets 1/2" FIPT, Pressure Compensating Cuatro-Flo™ Bubbler	Green	25/100	5.5	21DI

Adjustable Flow Rate Devices

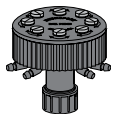

HYDROPORT™

Part No.	Description	Color	Bag Qty./ Box Qty.	Wt. per 100 (lbs.)	Product Class
Hydroport™					
HPAM 4	0-20 gph, Adjustable Flow, 1/2" FIPT, 4 Port Outlet Hydroport™ Adjustable Manifold	Black	10/30	30.0	21DI
HPAM 8	0-20 gph, Adjustable Flow, 1/2" FIPT, 8 Port Outlet Hydroport™ Adjustable Manifold	Black	10/30	30.0	21DI

MULTI-OUTLET DEVICES

Bubbler Accessories



Part No.	Description	Color	Bag Qty./ Box Qty.	Wt. per 100 (lbs.)	Product Class
OP 250	Outlet Plug for up to 2 Unused Outlets on Cuatro-Flo™ (CF) Drip Bubbler	Black	100/2,000	0.1	21DI

Spare Parts



Part No.	Description	Color	Bag Qty./ Box Qty.	Wt. per 100 (lbs.)	Product Class
D 80 H	Replacement Diaphragm for Cuatro-Flo™ (CF) Bubbler	Black	10/20	0.1	21DI

ADJUSTABLE EMITTERS – TECHNICAL INFORMATION





Hydro-Flo™ Jet (Adjustable) Model VF90 / VF180 / VF360

Radius (Feet)	Discharge (gph)		
	VF90	VF180	VF360
1 FT.	—	—	4.0 gph
2 FT.	—	6.5 gph	5.7 gph
3 FT.	12.4 gph	8.3 gph	7.8 gph
4 FT.	14.5 gph	10.2 gph	10.5 gph
5 FT.	16.2 gph	12.1 gph	12.7 gph
6 FT.	18.6 gph	14.5 gph	14.8 gph
7 FT.	20.1 gph	17.1 gph	16.8 gph
8 FT.	23.0 gph	21.8 gph	18.0 gph
9 FT.	25.3 gph	26.4 gph	21.2 gph
10 FT.	27.6 gph	—	23.5 gph
11 FT.	29.3 gph	—	25.6 gph
12 FT.	—	—	27.6 gph

Micro-Flo™
Micro-Sprinkler Model MFA

Radius (Feet)	Discharge (gph)
1 FT.	—
2 FT.	—
3 FT.	4.7 gph
4 FT.	6.6 gph
5 FT.	8.2 gph
6 FT.	9.8 gph
7 FT.	11.3 gph
8 FT.	13.2 gph
9 FT.	14.8 gph
10 FT.	16.4 gph

Dial-a-Flo™ Emitters

Part No.	Pattern
DAFB-360 / DAFT-360 DAFS-360 / DAFU-360	
DAFB-180 / DAFT-180 DAFS-180 / DAFU-180	
DAFB-FAN / DAFT-FAN DAFS-FAN / DAFU-FAN	
DAFB-BUB / DAFT-BUB DAFS-BUB / DAFU-BUB	

Model DAFB-360 / DAFT-360 / DAFS-360 / DAFU-360

Position	20 PSI		30 PSI		40 PSI	
	Discharge	Radius	Discharge	Radius	Discharge	Radius
0	0 gph	0"	0 gph	0"	0 gph	0"
1	1.8 gph	0"	2.3 gph	0"	2.7 gph	0"
2	2.4 gph	0"	3.1 gph	0"	3.5 gph	2"
3	3.0 gph	0"	3.9 gph	2"	4.6 gph	3"
4	3.7 gph	2"	4.8 gph	3"	5.6 gph	4"
5	4.4 gph	3"	5.7 gph	4"	6.7 gph	5"
6	5.0 gph	4"	6.5 gph	6"	7.6 gph	8"
7	5.6 gph	5"	7.2 gph	7"	8.4 gph	10"
8	6.2 gph	6"	8.1 gph	9"	9.1 gph	12"
1+	7.0 gph	7"	9.1 gph	11"	10.4 gph	14"
2+	7.9 gph	9"	10.3 gph	12"	11.7 gph	16"

Model DAFB-180 / DAFS-180 / DAFU-180

Position	20 PSI		30 PSI		40 PSI	
	Discharge	Radius	Discharge	Radius	Discharge	Radius
0	0 gph	0"	0 gph	0"	0 gph	0"
1	1.8 gph	4"	2.3 gph	6"	2.7 gph	9"
2	2.4 gph	7"	3.1 gph	10"	3.5 gph	13"
3	3.0 gph	9"	3.9 gph	13"	4.6 gph	18"
4	3.7 gph	11"	4.8 gph	16"	5.6 gph	24"
5	4.4 gph	13"	5.7 gph	19"	6.7 gph	30"
6	5.0 gph	15"	6.5 gph	24"	7.6 gph	35"
7	5.6 gph	18"	7.2 gph	27"	8.4 gph	40"
8	6.2 gph	21"	8.1 gph	30"	9.1 gph	44"
1+	7.0 gph	24"	9.1 gph	33"	10.4 gph	46"
2+	7.9 gph	26"	10.3 gph	36"	11.7 gph	48"

Model DAFB-FAN / DAFS-FAN / DAFU-FAN

Position	20 PSI		30 PSI		40 PSI	
	Discharge	Radius	Discharge	Radius	Discharge	Radius
0	0 gph	0"	0 gph	0"	0 gph	0"
1	3.8 gph	0"	5.0 gph	0"	5.8 gph	0"
2	6.3 gph	0"	8.2 gph	12"	9.5 gph	18"
3	9.5 gph	18"	12.4 gph	24"	14.3 gph	36"
4	10.6 gph	21"	13.6 gph	30"	16.0 gph	42"
5	11.4 gph	24"	14.8 gph	36"	17.1 gph	48"
6	12.1 gph	27"	15.6 gph	42"	18.1 gph	54"
7	13.0 gph	30"	16.5 gph	48"	19.0 gph	57"
8	13.5 gph	33"	17.1 gph	52"	20.0 gph	59"
1+	14.0 gph	35"	18.1 gph	54"	20.9 gph	61"
2+	14.3 gph	36"	18.7 gph	56"	21.6 gph	62"

Model DAFB-BUB / DAFS-BUB / DAFU-BUB / DAFT-BUB

Position	20 PSI		30 PSI		40 PSI	
	Discharge	Radius	Discharge	Radius	Discharge	Radius
0	0 gph	0"	0 gph	0"	0 gph	0"
1	3.8 gph	0"	5.0 gph	0"	5.8 gph	0"
2	6.3 gph	0"	8.2 gph	0"	9.5 gph	0"
3	9.5 gph	0"	12.4 gph	0"	14.3 gph	1"
4	10.6 gph	0"	13.6 gph	1"	16.0 gph	2"
5	11.4 gph	1"	14.8 gph	1"	17.1 gph	3"
6	12.1 gph	1"	15.6 gph	2"	18.1 gph	3"
7	13.0 gph	1"	16.5 gph	2"	19.0 gph	4"
8	13.5 gph	1"	17.1 gph	3"	20.0 gph	4"
1+	14.0 gph	2"	18.1 gph	3"	20.9 gph	5"
2+	14.3 gph	2"	18.7 gph	4"	21.6 gph	5"

TECHNICAL INFORMATION – DRIP & MICRO-SPRAY EMITTERS

Discharge Rates (GPH)

Model	Part No.	10 PSI	15 PSI	20 PSI	25 PSI	30 PSI	40 PSI	60 PSI	80 PSI
Hydroport™	HPAM 4	7.0 gph (Max)	10.0 gph (Max)	12.0 gph (Max)	13.0 gph (Max)	14.0 gph (Max)	16.0 gph (Max)	20.0 gph (Max)	
	HPAM 8	7.0 gph (Max)	10.0 gph (Max)	12.0 gph (Max)	13.0 gph (Max)	14.0 gph (Max)	16.0 gph (Max)	20.0 gph (Max)	
Super-Flo™ Emitter	TAE 10	0.56 gph	0.70 gph	0.80 gph	0.89 gph	0.97 gph			

Maximum Recommended Length of Run (Feet)

Hydro-Flo™ Jets, Micro-Flo™ Micro-Sprinkler

Orifice	Initial Pressure	I.D. of Tubing (inches)												
		.600"	.820"	1.040"	.600"	.820"	1.040"	.600"	.820"	1.040"	.600"	.820"	1.040"	
		Average Spacing Between Jets (feet)												
			6'			9'			12'			15'		
0.030"	20 PSI	210'	400'	620'	275'	520'	810'	340'	645'	1,000'	385'	730'	1,130'	
0.040"	20 PSI	140'	265'	415'	185'	350'	545'	225'	425'	600'	250'	475'	735'	
0.050"	20 PSI	110'	210'	325'	145'	275'	425'	175'	330'	515'	195'	370'	575'	
0.060"	20 PSI	85'	160'	250'	110'	210'	330'	135'	255'	400'	150'	290'	450'	









Tri-Flo™ Spray Stick

Model	Flow Node	Initial Pressure	I.D. of Tubing (inches)									
			.600"	.820"	.600"	.820"	.600"	.820"	.600"	.820"	.600"	.820"
			Average Spacing Between Spray Sticks (inches)									
			12"		24"		36"		48"		60"	
TFS 9	Low	20 PSI	75'	140'	115'	220'	150'	285'	180'	340'	210'	400'
	Medium	20 PSI	55'	105'	85'	160'	110'	205'	135'	250'	155'	290'
	High	20 PSI	45'	85'	70'	130'	90'	170'	110'	205'	125'	235'
TFS 16	Low	20 PSI	55'	105'	85'	160'	110'	205'	135'	250'	155'	290'
	Medium	20 PSI	45'	85'	70'	130'	90'	170'	110'	205'	125'	235'
	High	20 PSI	35'	65'	55'	105'	75'	140'	90'	170'	105'	200'

TECHNICAL INFORMATION – MICRO SPRAY EMITTERS

Discharge Rates (GPH) / Radius (feet)

Model	Part No.	15 PSI		20 PSI		25 PSI		30 PSI		40 PSI		45 PSI	
		Discharge	Radius	Discharge	Radius	Discharge	Radius	Discharge	Radius	Discharge	Radius	Discharge	Radius
Hydro-Flo™ Jet	TFB 30 (Black)	4.8 gph	5.0'	5.5 gph	6.0'	6.2 gph	7.0'	6.8 gph	8.0'				
	TFB 40 (Blue)	8.8 gph	7.0'	10.4 gph	8.0'	11.7 gph	8.0'	12.9 gph	9.0'				
	TFB 50 (Green)	13.8 gph	8.0'	15.8 gph	9.0'	17.7 gph	9.0'	19.5 gph	10.0'				
	TFB 60 (Red)	20.0 gph	8.0'	23.3 gph	9.0'	26.3 gph	10.0'	28.9 gph	11.0'				
	TFB 70 (White)	32.9 gph	9.0'	37.6 gph	10.0'	42.5 gph	11.0'	46.6 gph	12.0'				
	TF 336 (Black)	4.8 gph	4.0'	5.5 gph	4.5'	6.2 gph	5.0'	6.8 gph	5.0'				
	TF 436 (Blue)	8.8 gph	4.5'	10.4 gph	5.0'	11.7 gph	5.5'	12.9 gph	5.5'				
	TF 536 (Green)	13.8 gph	5.0'	15.8 gph	5.5'	17.7 gph	6.0'	19.5 gph	6.0'				
	TF 636 (Red)	20.0 gph	5.0'	23.3 gph	5.5'	26.3 gph	6.0'	28.9 gph	6.5'				
	TF 318 (Black)	4.8 gph	3.0'	5.5 gph	3.5'	6.2 gph	4.0'	6.8 gph	4.5'				
	TF 418 (Blue)	8.8 gph	3.5'	10.4 gph	4.0'	11.7 gph	4.5'	12.9 gph	5.0'				
	TF 518 (Green)	13.8 gph	4.0'	15.8 gph	4.5'	17.7 gph	5.0'	19.5 gph	5.5'				
	TF 618 (Red)	20.0 gph	4.5'	23.3 gph	5.0'	26.3 gph	5.5'	28.9 gph	6.0'				
	TF 39 (Black)	4.8 gph	4.0'	5.5 gph	4.5'	6.2 gph	5.5'	6.8 gph	6.0'				
	TF 49 (Blue)	8.8 gph	4.5'	10.4 gph	5.0'	11.7 gph	5.5'	12.9 gph	6.0'				
	TF 59 (Green)	13.8 gph	4.5'	15.8 gph	5.5'	17.7 gph	6.0'	19.5 gph	6.5'				
	TF 69 (Red)	20.2 gph	5.0'	23.3 gph	5.5'	26.3 gph	6.0'	28.9 gph	6.5'				
	AF 3xx (Black)	5.7 gph	5.0'	6.5 gph	6.0'	7.3 gph	7.0'	8.0 gph	8.0'				
Micro-Flo™ Micro-Sprinkler	MF 35 (Orange)	6.6 gph	6.0'	7.7 gph	7.0'	8.6 gph	8.0'	9.4 gph	8.0'				
	MF 40 (Blue)	8.6 gph	7.0'	10.0 gph	8.0'	11.3 gph	9.0'	12.4 gph	9.0'				
	MF 50 (Green)	13.6 gph	8.0'	16.0 gph	9.0'	17.9 gph	10.0'	19.7 gph	10.0'				
Tri-Flo™ Spray Stick	TFS 9 - Low	4.8 gph	1.0'	5.3 gph	1.5'	6.0 gph	2.0'						
	TFS 9 - Medium	7.1 gph	1.5'	7.9 gph	2.0'	9.0 gph	2.5'						
	TFS 9 - High	9.5 gph	3.0'	10.6 gph	3.5'	12.0 gph	4.0'						
	TFS 16 - Low	7.1 gph	1.5'	7.9 gph	2.0'	9.0 gph	2.5'						
	TFS 16 - Medium	9.5 gph	2.5'	10.6 gph	3.0'	12.0 gph	3.5'						
TFS 16 - High	14.3 gph	3.5'	15.9 gph	4.0'	18.0 gph	4.5'							

Model	Part No.	Pattern	Model	Part No.	Pattern
Hydro-Flo™ Jet	TFC 360		Tri-Flo™ Spray Stick	TFS 9	
	TFC 300			TFS 16	
	TFC 180, TF 318, TF 418, TF 518, TF 618				
	TFC 90, TF 39, TF 49, TF 59, TF 69				
	TF 336, TF 436, TF 536, TF 636				
	TFC 33				

Flushing Characteristics of Compensating Emitters*

Nominal Flow	Peak Flush Flow	Peak Flush Pressure
1	1.6 gph	3 PSI
2	3.0 gph	3 PSI

*Includes Mono Flo™ and Uni Flo™ Classic emitters.

FITTINGS & ACCESSORIES

Smart-Loc™ Multi-Diameter Fittings



Part No.	Description	Color	Bag Qty./ Box Qty.	Wt. per 100 (lbs.)	Product Class
CMAP 75-18	3/4" Male Pipe Thread Adaptor (Fits 16mm, 17mm & 18mm Tubing)	Black	25/250	0.375	21DI
SLC 18	Coupling (Fits 16mm, 17mm & 18mm Tubing)	Black	25/250	0.375	21DI
CEP 18	End Plug (Fits 16mm, 17mm & 18mm Tubing)	Black	25/250	0.375	21DI
CEL 18	Elbow (Fits 16mm, 17mm & 18mm Tubing)	Black	25/250	0.375	21DI
CMAH 18	Male Hose Thread Adaptor (Fits 16mm, 17mm & 18mm Tubing)	Black	25/250	0.375	21DI
CSA 18	Swivel Adaptor Female Hose Thread (Fits 16mm, 17mm & 18mm Tubing)	Black	25/250	0.375	21DI
CMAH 5-18	1/2" Male Pipe Thread Adaptor (Fits 16mm, 17mm & 18mm Tubing)	Black	25/250	0.375	21DI
CT 18	Tee (Fits 16mm, 17mm & 18mm Tubing)	Black	25/250	0.375	21DI

PROFESSIONAL IRRIGATION

Specifications

- Connect 16mm-18mm 1/2" polyethylene tubing
- Reduces Inventory
- Ideal for Tubing Repairs
- Durable Under the Most Demanding Conditions
- 8-80 PSI
- Accepts tubing OD of .620" to .710" (16mm-18mm)
- Made from UV-resistant, high-quality ABS material
- Reusable design – Tubing can be inserted & removed without damaging the fitting

WORKS WITH

DURA FLO™ DRIPLINE

and parts A620, A660, A700, A710 Supply Tubing



FITTINGS & ACCESSORIES

17MM Insert Fittings



Part No.	Description	Color	Bag Qty./ Box Qty.	Wt. per 100 (lbs.)	Product Class
BTMA 1750	17mm Insert x 1/2" MPT Adapter	Brown	10/bag	1.71	21DI
BTMA 1775	17mm Insert x 3/4" MPT Adapter	Brown	10/bag	2.40	21DI
BV 17	17mm Insert Ball Valve	Black	–	4.10	21DI
C 17	17mm Insert Coupling	Brown	25/bag	2.25	21DI
CX 17	17mm Insert Cross	Brown	–	–	21DI
EL 17	17mm Insert Elbow	Brown	25/bag	1.32	21DI
T 17	17mm Insert Tee	Brown	25/bag	1.73	21DI
TMA 1750	17mm Insert Tee x 1/2" MPT Adapter	Brown	–	2.35	21DI
YMA 1775	17mm Insert Y x 3/4" MPT Adapter	Brown	–	4.15	21DI

PROFESSIONAL IRRIGATION

FITTINGS & ACCESSORIES

Compression Solvent Weld Adapters

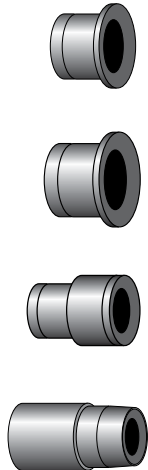

Part No.	Description	Color	Bag Qty./ Box Qty.	Wt. per 100 (lbs.)	Product Class
CA 250	Compression Adapter (1/2" Slip x .250" OD Tubing)	Orange	100/2,000	0.6	21DI
Use w/A 455 Tubing (3/8" Tubing)					
CA 600	Compression Adapter (1/2" Slip x .610" to .640" OD Tubing)	Green	100/2,000	0.5	21DI
Use w/A 620 Tubing (1/2" Tubing)					
CA 700	Compression Adapter (1/2" Slip x .680" to .704" OD Tubing)	Black	100/2,000	0.4	21DI
Use w/A 700 Tubing (1/2" Tubing)					
CA 710	Compression Adapter (1/2" Slip x .704" to .710" OD Tubing)	Blue	100/2,000	0.4	21DI
Use w/A 710 Tubing (1/2" Tubing)					
CA 900	Compression Adapter (3/4" Slip x .940" OD Tubing)	Grey	100/1,000	0.8	21DI
Use w/A 940 Tubing (3/4" Tubing)					
LCA 700	1/2" Compression Adapter (Long) (1/2" Slip x .680" to .704" OD Tubing)	Black	50/800	1.3	21DI
Use w/A 700 Tubing (1/2" Tubing)					
LCA 710	1/2" Compression Adapter (Long) (1/2" Slip x .704" to .710" OD Tubing)	Blue	50/800	1.3	21DI
Use w/A 710 Tubing (1/2" Tubing)					
SA 700	Socket Adapter - ID Bonds Over 1/2" PVC Pipe, OD Bonds into 3/4" PVC Socket	Black	100/600	1.5	21DI
Use w/A 700 Tubing (1/2" Tubing)					

PROFESSIONAL IRRIGATION

Compression Fittings

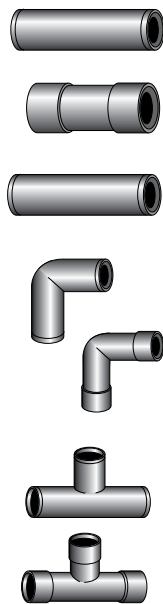

Part No.	Description	Color	Bag Qty./ Box Qty.	Wt. per 100 (lbs.)	Product Class
CC 600	Compression Coupling (Fits .610" to .640" OD Tubing i.e. A 620)	Green	25/1,000	2.8	21DI
CC 700	Compression Coupling (Fits .680" to .704" OD Tubing i.e. A 700)	Black	25/1,000	2.8	21DI
CC 710	Compression Coupling (Fits .704" to .710" OD Tubing i.e. A 710)	Blue	25/1,000	2.7	21DI
CC 800	Compression Coupling (Fits .830" OD Tubing)	Black	25/500	6.0	21DI
CC 900	Compression Coupling (Fits .940" OD Tubing i.e. A 940)	Grey	25/500	5.7	21DI
RCC 8090	Reducing Compression Coupling (800 Series to 900 Series)	Black/Grey	25/500	5.7	21DI
RCC 7090	Reducing Compression Coupling (700 Series to 900 Series)	Black/Grey	25/500	4.0	21DI
CEL 600	Compression Elbow (.610" to .640" OD Tubing i.e. A 620)	Green	25/800	3.9	21DI
CEL 700	Compression Elbow (.680" to .704" OD Tubing i.e. A 700)	Black	25/800	3.7	21DI
CEL 710	Compression Elbow (.704" to .710" OD Tubing i.e. A 710)	Blue	25/800	3.7	21DI
CEL 900	Compression Elbow (Fits .940" OD Tubing i.e. A 940)	Grey	25/500	5.9	21DI
CT 600	Compression Tee (.610" to .640" OD Tubing i.e. A 620)	Green	15/480	5.5	21DI
CT 700	Compression Tee (.680" to .704" OD Tubing i.e. A 700)	Black	15/480	5.2	21DI
CT 710	Compression Tee (.704" to .710" OD Tubing i.e. A 710)	Blue	15/480	5.2	21DI
CT 900	Compression Tee (Fits .940" OD Tubing i.e. A 940)	Grey	25/300	8.4	21DI

FITTINGS & ACCESSORIES

Compression End Caps

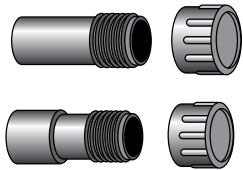

Part No.	Description	Color	Bag Qty./ Box Qty.	Wt. per 100 (lbs.)	Product Class
CEP 600	End Plug with Cap (Fits .610" to .640" OD Tubing i.e. A 620)	Green	25/800	4.0	21DI
CEP 700	End Plug with Cap (Fits .680" to .704" OD Tubing i.e. A 700)	Black	25/800	4.0	21DI
CEP 710	End Plug with Cap (Fits .704" to .710" OD Tubing i.e. A 710)	Blue	25/800	4.0	21DI
CEP 900	End Plug with Cap (Fits .940" OD Tubing i.e. A 940)	Grey	25/600	5.1	21DI

Note: All caps are unscrewing caps.

Compression Male Adapters

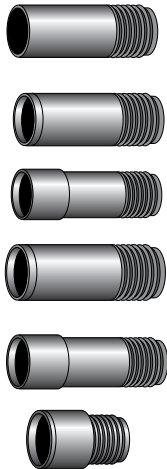

Part No.	Description	Color	Bag Qty./ Box Qty.	Wt. per 100 (lbs.)	Product Class
CMAH	3/4" MHT x 1/2" Slip Socket Adapter	Black	50/1,000	1.8	21DI
CMAH 700	3/4" MHT Adapter (Fits .680" to .704" OD Tubing i.e. A 700)	Black	50/1,000	2.2	21DI
CMAP 700	3/4" MIPT Adapter (Fits .680" to .704" OD Tubing)	Black	50/1,000	2.2	21DI
CMAP 710	3/4" MIPT Adapter (Fits .704" to .710" OD Tubing)	Blue	50/1,000	2.1	21DI
CMAP 800	3/4" MIPT Adapter (Fits .830" OD Tubing)	Black	25/800	3.5	21DI
CMAP 900	3/4" MIPT Adapter (Fits .940" OD Tubing)	Grey	25/800	3.3	21DI
CMAP5-600	1/2" MIPT Adapter (Fits .610" to .640" OD Tubing)	Green	50/1,000	1.6	21DI
CMAP5-700	1/2" MIPT Adapter (Fits .680" to .704" OD Tubing)	Black	50/1,000	1.5	21DI
CMAP5-710	1/2" MIPT Adapter (Fits .704" to .710" OD Tubing)	Blue	50/1,000	1.5	21DI

FITTINGS & ACCESSORIES

Compression 3/4" Swivel Fittings

PROFESSIONAL IRRIGATION

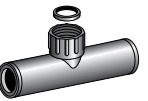
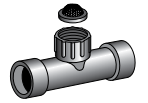
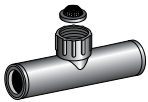
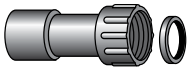
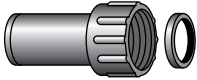
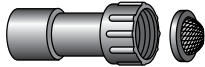
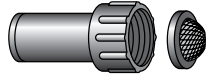

Part No.	Description	Color	Bag Qty./ Box Qty.	Wt. per 100 (lbs.)	Product Class
CSA 700	3/4" FHT Swivel Adapter (Fits .680" to .704" OD Tubing i.e. A 700)	Black	25/800	3.8	21DI
CSA 900	3/4" FHT Swivel Adapter (Fits .940" OD Tubing i.e. A 940)	Grey	25/600	4.8	21DI
Note: All adapters include screens as shown.					
CSAW 700	3/4" FHT Swivel Adapter w/Washer (Fits .680" to .704" OD Tubing)	Black	25/800	3.5	21DI
CSAW 710	3/4" FHT Swivel Adapter w/Washer (Fits .704" to .710" OD Tubing)	Blue	25/800	3.5	21DI
CSAW 900	3/4" FHT Swivel Adapter w/Washer (Fits .940" OD Tubing)	Grey	25/600	4.7	21DI
CST 600	3/4" FHT Swivel Tee w/Screen (Fits .610" to .640" OD Tubing)	Green	15/480	6.4	21DI
CST 700	3/4" FHT Swivel Tee w/Screen (Fits .680" to .704" OD Tubing)	Black	15/480	6.2	21DI
CSTW 600	3/4" FHT Swivel Tee w/Washer (Fits .610" to .640" OD Tubing)	Green	15/480	6.0	21DI
CSTW 900	3/4" FHT Swivel Tee w/Washer (Fits .940" OD Tubing)	Grey	25/300	8.0	21DI
CSEL 700	3/4" FHT Swivel Elbow w/Screen (Fits .680" to .704" OD Tubing)	Black	25/500	4.7	21DI
CSEL 710	3/4" FHT Swivel Elbow w/Screen (Fits .704" to .710" OD Tubing)	Blue	25/500	4.7	21DI
CSELW 700	3/4" FHT Swivel Elbow w/Washer (Fits .680" to .704" OD Tubing)	Black	25/500	4.4	21DI

FITTINGS & ACCESSORIES

Micro Fittings

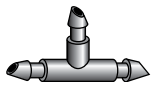
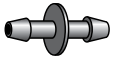

Part No.	Description	Color	Bag Qty./ Box Qty.	Wt. per 100 (lbs.)	Product Class
BT 250	Adapter - Barb x Thread (Fits 0.160" ID - 0.170" ID Tubing)	Black	100/2,000	0.1	21DI
Use with A 250 (1/4" tubing).					
TT 250	Adapter - Thread x Thread (Fits 0.160" ID - 0.170" ID Tubing)	Black	100/2,000	0.1	21DI
Use with A 250 (1/4" tubing).					
C 125	Connector (Barb x Barb) (Fits 0.125" ID Tubing)	Black	100/5,000	0.1	21DI
Use with A 185 (1/8" tubing).					
C 250	Connector (Barb x Barb) (Fits 0.160" ID - 0.170" ID Tubing)	Black	100/10,000	0.1	21DI
Use with A 250 (1/4" tubing).					
T 250	Tee (Barb x Barb x Barb) (Fits 0.160" ID - 0.170" ID Tubing)	Black	100/3,000	0.2	21DI
Use with A 250 (1/4" tubing).					
EL 250	Elbow (Barb x Barb x Barb) (Fits 0.160" ID - 0.170" ID Tubing)	Black	100/3,000	0.2	21DI
Use with A 250 (1/4" tubing).					
GP 2	Dual Goof Plug (20/Rack)	Black	100/10,000	0.1	21DI
Use with A 250 (1/4" tubing).					
SAT	Adapter for A 220 and A 250 Tubing (page 119) (1/2" FIPT x Barb)	Black	100/400	1.1	21DI
REA	Adapter for 1/4" Barbed Drip Emitter (1/2" FIPT x Emitter Socket dapter)	Black	100/400	1.3	21DI
ST 250	Adapter for Dura-Flo™ JR (page 97) and 1/4" Tubing (page XX) (1/2" FIPT x 1/4" Barbed Swivel Tee)	Black	100/300	1.4	21DI
SEL 250	Adapter for Dura-Flo™ JR (page 97) and 1/4" Tubing (page XX) (1/2" FIPT x 1/4" Barbed Swivel Elbow)	Black	100/300	1.4	21DI
RA 250	Riser Extension Adapter (1/2" FIPT x 1/2" MIPT x 1/4" Barb)	Black	25/100	2.6	21DI

FITTINGS & ACCESSORIES

Compression 1/2" Riser Adapters



Part No.	Description	Color	Bag Qty./ Box Qty.	Wt. per 100 (lbs.)	Product Class
RSTW 700	1/2" Riser Swivel Tee (Fits .680" to .704" OD Tubing)	Black	40/80	6.1	21DI
RSTW 710	1/2" Riser Swivel Tee (Fits .704" to .710" OD Tubing)	Blue	40/80	6.0	21DI
Products include washer.					
RSELW 700	1/2" Riser Swivel Elbow (Fits .680" to .704" OD Tubing)	Black	50/100	4.8	21DI
RSELW 710	1/2" Riser Swivel Elbow (Fits .704" to .710" OD Tubing)	Blue	50/100	4.8	21DI
Products include washer.					

Figure 8 End Enclosures



Part No.	Description	Color	Bag Qty./ Box Qty.	Wt. per 100 (lbs.)	Product Class
F 870	Figure "8" End Plug (Fits .620" OD to .710" OD Tubing)	Black	100/3,000	0.7	21DI
Fits A 620, A 700, A 710 Tubing					
F 890	Figure "8" End Plug (Fits .830" OD to .940" OD Tubing)	Black	100/1,500	1.5	21DI
Fits A 940 Tubing					

Sod Staples

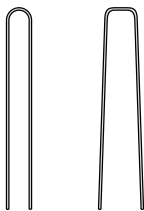

Part No.	Description	Color	Bag Qty./ Box Qty.	Wt. per 100 (lbs.)	Product Class
FW6	6" Sod Staple Flat Top	N/A	N/A/1,000	3.5	21DT
FW6/100	6" Sod Staple Flat Top	N/A	100/N/A	3.5	21DT
FW6/25	6" Sod Staple Flat Top	N/A	25/N/A	3.5	21DT
SW6	6" Sod Staple Round Top	N/A	N/A/1,000	3.4	21DT
SW6/100	6" Sod Staple Round Top	N/A	100/N/A	3.4	21DT

FITTINGS & ACCESSORIES

Stakes

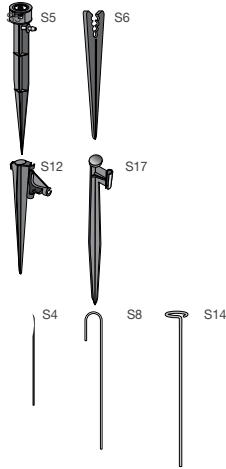

Part No.	Description	Color	Bag Qty./ Box Qty.	Wt. per 100 (lbs.)	Product Class
S 5	5" Plastic Elbow Stake with 1/4" Barbed Side Inlet and 10/32 NPT Outlet	Black	100/1,500	1.4	21DI
S 6	6" Plastic Stake (Fits A 185, A 220 and A 250 Tubing)	Black	100/3,000	1.0	21DI
S 12	12" Plastic Stake to Hold A 250/V 250 Tubing	Black	100/300	6.2	21DI
S 17	17" Plastic Stake to Support .160" ID x .300" OD Rigid Risers	Black	250/250	9.4	21DI
S 4	5" 14-Gauge Galvanized Wire Stake	Silver	100/2,500	1.2	21DI
S 8	8" 12-Gauge Galvanized Wire Stake	Silver	100/2,000	0.5	21DI
S 14	14" 11-Gauge Galvanized Wire Stabilizer Stake for Rigid Riser Jet Assemblies	Silver	50/1,000	5.0	21DI

Valves

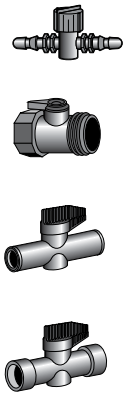

Part No.	Description	Color	Bag Qty./ Box Qty.	Wt. per 100 (lbs.)	Product Class
MV 25	1/4" Flow Controlling Valve (Barb x Barb) (Fits .160" to .170" ID Tubing i.e. A 250)	Black	100/500	0.4	21DI
BV 75	3/4" FHT x 3/4" MHT Ball Valve	Black	25/150	3.8	21DI
FC 700	1/2" Flow Controlling Valve (Fits .680" to .704" OD Tubing i.e. A 700)	Black	25/200	5.4	21DI
FC 710	1/2" Flow Controlling Valve (Fits .704" to .710" OD Tubing i.e. A 710)	Blue	25/200	5.4	21DI
Note: Not to be used as a shutoff valve.					
FC 900	3/4" Flow Controlling Valve (Fits .940" OD Tubing i.e. A 940)	Grey	25/125	7.5	21DI

FITTINGS & ACCESSORIES

Air/Vacuum Valves



Part No.	Description	Color	Bag Qty./ Box Qty.	Wt. per 100 (lbs.)	Product Class
AVRV 50	1/2" Air/Vacuum release valve (1/2" MIPT inlet)	Black	25/100	1.6	21DI

Hole Punches

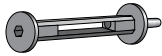

Part No.	Description	Color	Bag Qty./ Box Qty.	Wt. per 100 (lbs.)	Product Class
HP 100	Hole Punch for 1/8" Fittings. Insert Tool for BT 250, TT 250 Fittings	Blue	10/150	3.8	21DI
HP 125	Hole Punch for PC Plus™, Multi-Flo™, Aqua-Flo™, Dial-a-Flo™, Super-Flo™, Misti-Flo™ and 1/4" Fittings. Insert Tool for BT 250, TT 250 Fittings.	Green	10/150	3.8	21DI
HP 240	Hole Punch for Mono-Flo™ Emitters	Blue	10/50	4.1	21DI

Emitter Access Boxes



Part No.	Description	Color	Bag Qty./ Box Qty.	Wt. per 100 (lbs.)	Product Class
EB 6	6" Emitter/Bubbler Access Box	Black	24/24	57.7	21DI
EBDS 6	6" Emitter/Bubbler Access Box for Desert Landscaping	Tan	24/24	57.7	21DI
EBRC 6	6" Emitter/Bubbler Access Box for Reclaimed Water	Purple	N/A/24	57.7	21DI

Tubing Accessories and Miscellaneous

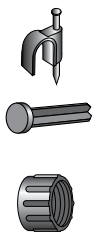

Part No.	Description	Color	Bag Qty./ Box Qty.	Wt. per 100 (lbs.)	Product Class
MC 250	1/4" Mounting Clamp (Fits A 220 and A 250 Tubing)	Black	100/4,000	0.2	21DI
MC 710	1/2" Mounting Clamp (Fits A 620 and A 700 Tubing)	Black	100/1,000	0.6	21DI
BP 250	Bug Plug for A 220 and A 250	Black	100/5,000	0.1	21DI
CAP 75	3/4" FHT Cap with Washer	Black	100/1,500	1.8	21DI

DISTRIBUTION TUBING

Distribution & Supply Tubing

50 ft. & 100 ft. Coils in Shrink Wrapped Packaging



Self Coil

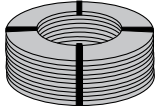

Plastic Hub (1") w/Chipboard Flanges

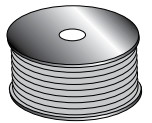

Sunburst Cardboard Spool



Self Coil

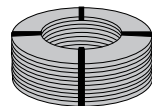

Sunburst cardboard spool

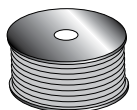

Plastic hub (1") with chipboard flanges



Bucket

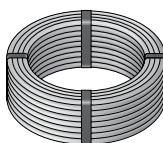

Supply Tubing

Part No.	Description	Color	Coil Size/Type	Wt. per 100' (lbs.)	Product Class
A 185/1000	1/8" Polyethylene Tubing (0.125" ID x 0.185" OD)	Black	1,000'/Spool	0.6	21DT
A 185V	1/8" Vinyl Tubing (0.125" ID x 0.185" OD)	Black	2,000'/Spool	1.0	21DT
A 185V/100	1/8" Vinyl Tubing (0.125" ID x 0.185" OD)	Black	100'/Coil	1.0	21DT
A 185V/1000	1/8" Vinyl Tubing (0.125" ID x 0.185" OD)	Black	1,000'/Spool	1.0	21DT
A 220	1/4" Polyethylene Tubing (0.160" ID x 0.220" OD)	Black	1,500'/Spool	0.7	21DT
A 220/100	1/4" Polyethylene Tubing (0.160" ID x 0.220" OD)	Black	100'/Coil	0.7	21DT
A 220/1000	1/4" Polyethylene Tubing (0.160" ID x 0.220" OD)	Black	1,000'/Spool	0.7	21DT
A 220/2500	1/4" Polyethylene Tubing (0.160" ID x 0.220" OD)	Black	2,500'/Spool	0.7	21DT
A 220V	1/4" Vinyl Tubing (0.160" ID x 0.220" OD)	Black	1,500'/Spool	1.2	21DT
A 220V/100	1/4" Vinyl Tubing (0.160" ID x 0.220" OD)	Black	100'/Coil	1.2	21DT
A 220V/1000	1/4" Vinyl Tubing (0.160" ID x 0.220" OD)	Black	1,000'/Spool	1.2	21DT
A 220V/2500	1/4" Vinyl Tubing (0.160" ID x 0.220" OD)	Black	2,500'/Spool	1.2	21DT
A 250	1/4" Polyethylene Tubing (0.170" ID x 0.250" OD)	Black	1,250'/Spool	1.1	21DT
A 250/100	1/4" Polyethylene Tubing (0.170" ID x 0.250" OD)	Black	100'/Coil	1.1	21DT
A 250BR/100	1/4" Polyethylene Tubing (0.170" ID x 0.250" OD)	Brown	100'/Coil	1.1	21DT
A 250/500	1/4" Polyethylene Tubing (0.170" ID x 0.250" OD)	Black	500'/Spool	1.1	21DT
A 250/1000	1/4" Polyethylene Tubing (0.170" ID x 0.250" OD)	Black	1,000'/Spool	1.1	21DT
A 250/1000B	1/4" Polyethylene Tubing (0.170" ID x 0.250" OD) in Bucket	Black	1,000'/Spool in Bucket	1.1	21DT
A 250/2500	1/4" Polyethylene Tubing (0.170" ID x 0.250" OD)	Black	2,500'/Spool	1.1	21DT
A 250V/50	1/4" Vinyl Tubing (0.170" ID x 0.250" OD)	Black	50'/Coil	1.6	21DT
A 250V/100	1/4" Vinyl Tubing (0.170" ID x 0.250" OD)	Black	100'/Coil	1.6	21DT
A 250V/500	1/4" Vinyl Tubing (0.170" ID x 0.250" OD)	Black	500'/Spool	1.6	21DT
A 250V/1000	1/4" Vinyl Tubing (0.170" ID x 0.250" OD)	Black	1,000'/Spool	1.6	21DT
A 250V/1000B	1/4" Vinyl Tubing (0.170" ID x 0.250" OD) in Bucket	Black	1,000'/Spool in Bucket	1.6	21DT

PROFESSIONAL IRRIGATION

DISTRIBUTION TUBING

Distribution & Supply Tubing

All 17mm Coils in Shrink Wrapped Packaging



PROFESSIONAL IRRIGATION



Self Coil

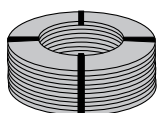

Plastic Hub (1")
w/Chipboard Flanges

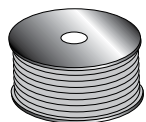

Sunburst
Cardboard Spool



Self Coil

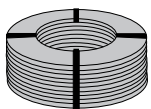

Sunburst Cardboard Spool

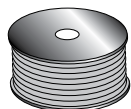

Plastic Hub (1")
w/ Chipboard Flanges

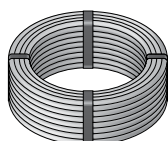

Supply Tubing

Part No.	Description	Color	Coil Size/Type	Wt. per 100' (lbs.)	Product Class
A 620BR/100	1/2" Polyethylene Tubing (0.520" ID x 0.620" OD)	Brown	100'/Coil	3.6	21DT
A 620/500	1/2" Polyethylene Tubing (0.520" ID x 0.620" OD)	Black	500'/Coil	3.6	21DT
A 620BR/500	1/2" Polyethylene Tubing (0.520" ID x 0.620" OD)	Brown	500'/Coil	3.6	21DT
A 660BR/100S	17mm Polyethylene Tubing (0.560" ID x 0.660" OD)	Brown	100'/Wrapped Coil	3.8	21DT
A 660BR/250S	17mm Polyethylene Tubing (0.560" ID x 0.660" OD)	Brown	250'/Wrapped Coil	3.8	21DT
A 660BR/500S	17mm Polyethylene Tubing (0.560" ID x 0.660" OD)	Brown	500'/Wrapped Coil	3.8	21DT
A 700	1/2" Polyethylene Tubing (0.600" ID x 0.700" OD)	Black	500'/Coil	4.1	21DT
A 700SH	1/2" Polyethylene Tubing (0.600" ID x 0.700" OD)	Black	500'/Wrapped Coil	4.1	21DT
A 700/100	1/2" Polyethylene Tubing (0.600" ID x 0.700" OD)	Black	100'/Coil	4.1	21DT
A 700/100SH	1/2" Polyethylene Tubing (0.600" ID x 0.700" OD)	Black	100'/Wrapped Coil	4.1	21DT
A 700/1000	1/2" Polyethylene Tubing (0.600" ID x 0.700" OD)	Black	1,000'/Coil	4.1	21DT
A 710	1/2" Polyethylene Tubing (0.620" ID x 0.710" OD)	Black	500'/Coil	3.8	21DT
A 710GRS	1/2" Polyethylene Tubing (0.620" ID x 0.710" OD)	Black/ Green Stripe	500'/Coil	3.8	21DT
A 710PS	1/2" Polyethylene Tubing (0.620" ID x 0.710" OD)	Black/ Purple Stripe	500'/Coil	3.8	21DT
A 710RDS	1/2" Polyethylene Tubing (0.620" ID x 0.710" OD)	Black/ Red Stripe	500'/Coil	3.8	21DT
A 710WHS	1/2" Polyethylene Tubing (0.620" ID x 0.710" OD)	Black/ White Stripe	500'/Coil	3.8	21DT
A 710YS	1/2" Polyethylene Tubing (0.620" ID x 0.710" OD)	Black/ Yellow Stripe	500'/Coil	3.8	21DT
A 710SH	1/2" Polyethylene Tubing (0.620" ID x 0.710" OD)	Black	500'/Wrapped Coil	3.8	21DT
A 710/100	1/2" Polyethylene Tubing (0.620" ID x 0.710" OD)	Black	100'/Coil	3.8	21DT
A 710/100SH	1/2" Polyethylene Tubing (0.620" ID x 0.710" OD)	Black	100'/Wrapped Coil	3.8	21DT
A 710/1000	1/2" Polyethylene Tubing (0.620" ID x 0.710" OD)	Black	1,000'/Coil	3.8	21DT
A 940	3/4" Polyethylene Tubing (0.830" ID x 0.940" OD)	Black	500'/Coil	6.4	21DT
A 940RDS	3/4" Polyethylene Tubing (0.830" ID x 0.940" OD)	Black/ Red Stripe	500'/Coil	6.4	21DT
A 940WHS	3/4" Polyethylene Tubing (0.830" ID x 0.940" OD)	Black/ White Stripe	500'/Coil	6.4	21DT
A 940YS	3/4" Polyethylene Tubing (0.830" ID x 0.940" OD)	Black/ Yellow Stripe	500'/Coil	6.4	21DT
A 940PS	3/4" Polyethylene Tubing (0.830" ID x 0.940" OD)	Purple Stripe	N/A	N/A	21DT
A 940GRS	3/4" Polyethylene Tubing (0.830" ID x 0.940" OD)	Green Stripe	500'/Coil	6.4	21DT
A 940/100	3/4" Polyethylene Tubing (0.830" ID x 0.940" OD)	Black	100'/Coil	6.4	21DT
A 940/1000	3/4" Polyethylene Tubing (0.830" ID x 0.940" OD)	Black	1,000'/Coil	6.4	21DT
A 1200	1" Polyethylene Tubing (1.060" ID x 1.200" OD)	Black	500'/Coil	9.8	21DT

DISTRIBUTION TUBING

IPS Flex Pipe



Part No.	Description	Color	Bag Qty./ Box Qty.	Wt. per 100' (lbs.)	Product Class
IPS 50/100	1/2" IPS Flex Vinyl Pipe (0.546" ID x 0.840" OD, 0.147" Wall)	Black	100'	20.5	21DT
IPS 75/100	3/4" IPS Flex Vinyl Pipe (0.742" ID x 1.050" OD, 0.154" Wall)	Black	100'	28.5	21DT

Swing Pipe



Part No.	Description	Color	Bag Qty./ Box Qty.	Wt. per 100' (lbs.)	Product Class
SRP FLEX/100SH	1/2" Super Flexee™ Swing Riser Pipe (0.490" ID x 0.690" OD), Shrinkwrapped	Black	100'/1,000'	7.7	21DT

TUBING FRACTIONAL LOSSES

Polyethylene Supply Tubing – Friction Loss (PSI/100 Feet)

Flow	Part Number				
	A455	A620	A700	A710	A940
0.5 gpm	1.80	0.37	0.19	0.16	0.05
1.0 gpm	6.6	1.33	0.68	0.55	0.15
1.5 gpm	12.2	2.45	1.24	1.01	0.32
2.0 gpm		4.80	2.17	1.78	0.53
2.5 gpm		6.18	3.13	2.56	0.82
3.0 gpm		10.31	5.16	4.23	1.11
3.5 gpm			6.85	5.62	1.52
4.0 gpm			8.78	7.20	1.90
4.5 gpm			10.32	8.46	2.42
5.0 gpm				10.10	2.88
6.0 gpm					4.03
7.0 gpm					5.37
8.0 gpm					6.87
9.0 gpm					8.53
10.0 gpm					10.37

IPS Flex PVC Hose – Friction Loss (PSI/100 Feet)

Flow	Part Number	
	IPS 50	IPS 75
0.5 gpm	0.31	0.07
1.0 gpm	1.10	0.23
1.5 gpm	2.09	0.45
2.0 gpm	3.85	0.75
2.5 gpm	5.10	1.15
3.0 gpm	8.52	1.55
3.5 gpm	11.34	2.14
4.0 gpm	13.86	2.66
5.0 gpm		3.92
6.0 gpm		5.65
7.0 gpm		7.51
8.0 gpm		9.62
9.0 gpm		11.95
10.0 gpm		14.52

Polyethylene/Vinyl Micro-Tubing – Friction Loss (PSI/100 Feet)

Flow	Part Number		
	A 185/V	A 220/V	A 250/V
3 gph	5.9	1.7	1.3
6 gph	19.7	5.8	4.3
9 gph	41.5	12.2	9.1
12 gph		20.9	15.6
15 gph		31.7	23.9
18 gph		43.9	33.0
21 gph			44.3

“Flexee” Swing Riser Pipe – Friction Loss (PSI/100 Feet)

Flow	Part Number
	SRP 100
0.5 gpm	0.40
1.0 gpm	1.47
1.5 gpm	2.70
2.0 gpm	5.28
2.5 gpm	6.80
3.0 gpm	11.35

TECHNICAL INFORMATION – CONVERSION FACTORS

To Convert From	To	Multiply by
AREA		
Acres	Sq. Feet	43,560
Acres	Sq. Meters	4,046.8
Sq. Centimeters	Sq. Feet	0.00108
Sq. Centimeters	Sq. Inches	0.1550
Sq. Feet	Sq. Centimeters	929.03
Sq. Feet	Sq. Inches	144
Sq. Feet	Sq. Meters	0.0929
Sq. Feet	Sq. Yards	0.1111
Sq. Inches	Sq. Centimeters	6.4516
Sq. Inches	Sq. Feet	0.00694
Sq. Inches	Sq. Meters	0.000645
Sq. Meters	Sq. Feet	10.764
Sq. Meters	Sq. Yards	1.196
Sq. Yards	Sq. Feet	9
Sq. Yards	Sq. Meters	0.8361
ENERGY AND POWER		
Foot Pounds	BTU	0.001285
Foot Pounds	Joules	1.3558
Foot Pounds	Kilogram-Meters	0.13826
Foot Pound per Minute	Horsepower	0.0000303
Horsepower	BTU per Minute	42.41
Horsepower	Foot Pound per Minute	33,000
Horsepower	Foot Pound per Second	550
Horsepower	Kilowatts	0.7457
FLOW		
Cubic Feet per Minute	Cubic Meters per Second	0.0004719
Cubic Feet per Second	Cubic Meters per Second	0.02832
Cubic Yards/Minute	Cubic Meters per Second	0.01274
Gallons/Minute	Cubic Meters per Second	0.0000631
Gallons/Minute	Cubic Meters per Hour	0.22716
LENGTH		
Centimeters	Inches	0.3937
Centimeters	Yards	0.01094
Feet	Inches	12
Feet	Meters	0.30481
Feet	Yards	0.333
Inches	Centimeters	2.540
Inches	Feet	0.08333
Inches	Meters	0.02540
Inches	Microns	25.400
Inches	Millimeters	25.400
Inches	Yards	0.2778
Kilometers	Feet	3.281
Kilometers	Miles (Nautical)	0.5336
Kilometers	Miles (Statue)	0.6214
Kilometers	Yards	1.094
Meters	Feet	3.2809
Meters	Yards	1.0936
Miles (Statue)	Feet	5.280
Miles	Kilometers	1.6093
Miles (Statue)	Meters	1,609.34
Miles (Statue)	Yards	1,760
Miles (Nautical)	Kilometers	1,852
Miles (Nautical)	Meters	1.8520
Millimeters	Inches	0.03937
Rods	Meters	5.0292
Yards	Centimeters	0.9144
Yards	Feet	3
Yards	Inches	36
Yards	Meters	0.9144

To Convert From	To	Multiply by
PRESSURE		
Kilograms/Sq. Cm.	Pounds per Sq. Inch	14,223
Kilograms/Sq. Meter	Pounds per Sq. Foot	0.2048
Kilograms/Cubic Meter	Pounds per Cubic Foot	0.0624
Pounds per Cubic Foot	Kilograms/Cubic Meter	16,019
Pounds per Sq. Foot	Kilograms/Sq. Meter	4.8824
Pounds per Sq. Inch	Kilograms/Sq. Cm.	0.0703
VELOCITY		
Feet/Minute	Meters per Second	0.00508
Feet/Second	Meters per Second	0.3048
Inches/Second	Meters per Second	0.0254
VOLUME		
Cubic Centimeters	Cubic Inches	0.06102
Cubic Feet	Cubic Inches	1,728
Cubic Feet	Cubic Meters	0.0283
Cubic Feet	Cubic Yards	0.0370
Cubic Feet	Gallons	7.481
Cubic Feet	Liters	28.32
Cubic Feet	Quarts	29.9222
Cubic Inches	Cubic Centimeters	16.39
Cubic Inches	Cubic Feet	0.0005787
Cubic Inches	Cubic Meters	0.00001639
Cubic Inches	Liters	0.0164
Cubic Inches	Gallons	0.004329
Cubic Inches	Quarts	0.01732
Cubic Meters	Cubic Feet	35.31
Cubic Meters	Cubic Inches	61,023
Cubic Meters	Cubic Yards	1.3087
Cubic Yards	Cubic Feet	27
Cubic Yards	Cubic Meters	0.7641
Gallons	Cubic Feet	0.1337
Gallons	Cubic Inches	231
Gallons	Cubic Meters	0.003785
Gallons	Liters	3.785
Gallons	Quarts	4
Liters	Cubic Feet	0.03531
Liters	Cubic Inches	61.017
Liters	Gallons	0.2642
Liters	Pints	2.1133
Liters	Quarts	1.057
Liters	Cubic Meters	0.0010

PROFESSIONAL IRRIGATION PRODUCTS INDEX

Part No.	Page	Part No.	Page	Part No.	Page	Part No.	Page	Part No.	Page
A 185/1000	135	BP 250	134	CSTW 900	130	IPS 50/100	137	SFCV-BR-7218-01	112
A 185V	135	BT 250	131	CT 18	126	IPS 75/100	137	SFCV-BR-7218-025	112
A 185V/100	135	BTMA 1750	127	CT 600	128	LCA 700	128	SFCV-BR-7412-01	112
A 185V/1000	135	BTMA 1775	127	CT 700	128	LCA 710	128	SFCV-BR-7412-10	112
A 220	135	BV 17	127	CT 710	128	MC 250	134	SFCV-BR-7412-025	112
A 220/100	135	BV 75	133	CT 900	128	MC 710	134	SFJR-BL-06-01	113
A 220/1000	135	C 17	127	CX 17	127	MCO-0500	107	SFJR-BL-06-10	113
A 220/2500	135	C 125	131	CZK 100-30F	103	MCO-0500-12	107	SFJR-BL-12-01	113
A 220V	135	C 250	131	CZK 100-40F	103	MCO-0750	107	SFJR-BR-06-01	113
A 220V/100	135	CA 250	128	CZK 100-40VB1	103	MCO-0750-R	107	SFJR-BR-12-01	113
A 220V/1000	135	CA 600	128	D 80 H	122	MFA	119	SFFC-BL-6412-01	111
A 220V/2500	135	CA 700	128	DAFB 180	117	MV 25	133	SFFC-BL-6418-05	111
A 250	135	CA 710	128	DAFB 360	117	OP 250	122	SFFC-BL-7212-01	112
A 250/100	135	CA 900	128	DAFB BUB	117	PR 20	104	SFFC-BL-7212-05	112
A 250/500	135	CAP 75	134	DAFB FAN	117	PR 30	104	SFFC-BL-7412-01	112
A 250/1000	135	CAP POP/5	103	DAFS 135	117	PRH 20	105	SFFC-BL-7412-05	112
A 250/1000B	135	CAP POP/25	103	DAFS 180	117	PRH 30	105	SFFC-BL-7418-05	112
A 250/2500	135	CC 600	128	DAFS 360	117	PRH 40	105	SFFC-BR-6212-05	111
A 250BR/100	135	CC 700	128	DAFS BUB	117	PRM 30	104	SFFC-BR-6212-025	111
A 250V/50	135	CC 710	128	DAFT 180	117	PRP 20	104	SFFC-BR-6412-01	111
A 250V/100	135	CC 800	128	DAFT 360	117	PRP 30	104	SFFC-BR-6412-05	111
A 250V/500	135	CC 900	128	DAFT BUB	117	PRP 40	105	SFFC-BR-6412-025	111
A 250V/1000	135	CEL 18	126	DAFT FAN	117	PRYF 30	103	SFFC-BR-6418-01	111
A 250V/1000B	135	CEL 600	128	DFHD-BL-05-116-05	113	PRYF 40	103	SFFC-BR-6418-05	111
A 620/500	136	CEL 700	128	DFHD-BL-10-114-05	113	R 12	120	SFFC-BR-6418-025	111
A 620BR/100	136	CEL 710	128	dkz 700/710	103	RA 250	131	SFFC-BR-7212-01	112
A 620BR/500	136	CEL 900	128	EB 6	134	RABB 8	120	SFFC-BR-7218-05	112
A 660BR/100S	136	CEP 18	126	EBDS 6	134	RABT 12	120	SFFC-BR-7412-01	112
A 660BR/250S	136	CEP 600	129	EBRC 6	134	RATT 12	120	SFFC-BR-7412-05	112
A 660BR/500S	136	CEP 700	129	EL 17	127	RCC 7090	128	SFFC-BR-7418-05	112
A 675CT	103	CEP 710	129	EL 250	131	RCC 8090	128	SFFC-BR-17212-01S	110
A 700	136	CEP 900	129	F 870	132	REA	131	SFFC-BR-17212-05S	110
A 700/100	136	CFL 2	121	F 890	132	RSELW 700	132	SFFC-BR-17212-025S	110
A 700/100SH	136	CFL 6	121	FC 700	133	RSELW 710	132	SFFC-BR-17218-01S	110
A 700/1000	136	CFL 10	121	FC 710	133	RSTW 700	132	SFFC-BR-17218-05S	110
A 700SH	136	CFL 20	121	FC 900	133	RSTW 710	132	SFFC-BR-17218-025S	110
A 710	136	CMAH	129	FCO-0500	107	RW16N	118	SFFC-BR-17412-05S	110
A 710/100	136	CMAH 18	126	FCO-0750-R	107	RW16N6P	118	SFFC-BR-17412-10	110
A 710/100SH	136	CMAH 700	129	FPA-0500	105, 107	S 4	133	SFFC-BR-17412-025S	110
A 710/1000	136	CMAH 5-18	126	FPA-0750	105, 107	S 5	133	SFFC-PS-17412-05S	110
A 710GRS	136	CMAH5-600	129	FPC-0490	105, 107	S5R6	120	SFFC-RC-17412-05S	110
A 710PS	136	CMAH5-700	129	FPE-0500	105, 107	S5R8	120	SLC 18	126
A 710RDS	136	CMAH5-710	129	FPE-0500F	107	S5R12	120	SRP FLEX/100SH	137
A 710SH	136	CMAH 6	120	FPE-0750	105, 107	S 6	133	ST 250	131
A 710WHS	136	CMAH 12	120	FPT-0500	107	S 8	133	ST 700	130
A 710YS	136	CMAH 75-18	126	FR2 17-710	103	S 12	133	STL-0500	107
A 940	136	CMAH 700	129	FR-0500-4	107	S 14	133	STL-0750	107
A 940/100	136	CMAH 710	129	FR-0500-4F	107	S 17	133	SW6	132
A 940/1000	136	CMAH 800	129	FR-0500-6	107	SA 700	128	SW6/100	132
A 940GRS	136	CMAH 900	129	FR-0500-6F	107	SAM-0500	107	T 17	127
A 940PS	136	CRE-0500-3	107	FR-0750-6	107	SAT	131	T 250	131
A 940RDS	136	CRE-0750-4	107	FR-1000-7	107	SEL 250	131	TA 24-1XY	120
A 940WHS	136	CSA 18	126	FW6	132	SFCV-BR-6212-01S	109	TA 24-2XY	120
A 940YS	136	CSA 700	130	FW6/25	132	SFCV-BR-6212-05S	109	TA 24-3X	120
A 1200	136	CSA 900	130	FW6/100	132	SFCV-BR-6212-025S	109	TA 24-4	120
AFPC 5	117	CSAW 700	130	GP 2	131	SFCV-BR-6412-01S	109	TA 24-5	120
AFPC 5/1000	117	CSAW 710	130	HP 100	134	SFCV-BR-6412-05S	109	TA 24-6	120
AFPC 10	117	CSAW 900	130	HP 125	134	SFCV-BR-6412-025S	109	TA 24-7	120
AFPC 20	117	CSEL 700	130	HP 240	134	SFCV-BR-6418-01S	109	TAE 10	118
AFPC 20/25	117	CSEL 710	130	HPAM 4	121	SFCV-BR-6418-05S	109	TAE 20	118
AFPC 50	117	CSELW 700	130	HPAM 8	121	SFCV-BR-6418-025S	109	TAE 40	118
AFPC 50/1000	117	CST 600	130	HYP 250	119	SFCV-BR-6424-05S	109	TF 49	118
AVRV 50	134	CSTW 600	130	HYPJ 250	119	SFCV-BR-7212-01	112	TF 59	118

FLOW MANAGEMENT





FLOW MANAGEMENT



NDS® Flow Management offers a range of engineered specialty fittings and valves. From expansion repair and compression couplings, to spring, swing check and ball valves, we offer a full line of products for irrigation, plumbing, pool and spa, and industrial applications.

COMPRESSION FITTINGS

IPS Couplings, Tees & Adapters *(Rated @ 150 PSI Static Pressure @ 72°F)*

Part No.	Ref. No.	IPS Size UC Connection	IPS Branch	Body Length	Color	Pkg. Qty.	Case (lbs.)	Product Class	Specifications	
Couplings — PVC										
	CPC-0500	110-05	1/2"		4-1/2"	White	30	7.0	42CP	PVC NSF/ANSI 61+372 UPC
	CPC-0750	110-07	3/4"		5-1/4"	White	24	8.2	42CP	
	CPC-1000	110-10	1"		5-3/4"	White	18	8.2	42CP	
	CPC-1250	110-12	1-1/4"		6-1/4"	White	12	7.6	42CP	
	CPC-1500	110-15	1-1/2"		6-3/4"	White	15	12.25	42CP	
	CPC-2000	110-20	2"		7-1/8"	White	12	14.2	42CP	
	CPC-2500	110-25	2-1/2"		9-5/8"	White	5	12.25	42CP	
	CPC-3000	110-30	3"		10-7/8"	White	4	13.2	42CP	
	CPC-4000	110-40	4"		12-1/8"	White	3	13.9	42CP	
	CPC-6000	110-60	6"		11-3/8"	White	1	8.6	42CP	
Slip Tee										
	CPT-0500-S	121-05	1/2"	1/2" S	5"	White	24	7.0	42CP	PVC NSF/ANSI 61+372 UPC
	CPT-0750-S	121-07	3/4"	3/4" S	5-3/8"	White	20	8.0	42CP	
	CPT-1000-S	121-10	1"	1" S	5-5/8"	White	12	7.0	42CP	
	CPT-1250-S	121-12	1-1/4"	1-1/4" S	6-1/8"	White	8	6.2	42CP	
	CPT-1500-S	121-15	1-1/2"	1-1/2" S	6-3/4"	White	6	6.4	42CP	
	CPT-2000-S	121-20	2"	2" S	7-1/2"	White	5	7.25	42CP	
Threaded Tee										
	CPT-0500-T	120-05	1/2"	1/2" FPT	5"	White	24	7.0	42CP	PVC NSF/ANSI 61+372
	CPT-0750-T	120-07	3/4"	3/4" FPT	5-3/8"	White	20	8.0	42CP	
	CPT-1000-T	120-10	1"	1" FPT	5-5/8"	White	12	7.0	42CP	
	CPT-1250-T	120-12	1-1/4"	1-1/4" FPT	6-1/8"	White	8	6.2	42CP	
	CPT-1500-T	120-15	1-1/2"	1-1/2" FPT	6-3/4"	White	6	6.4	42CP	
Reducing Tee w/Threaded Outlet										
	CRT-0750-T	122-75	3/4"	1/2" FPT	5-3/8"	White	20	8.0	42CP	PVC NSF/ANSI 61+372

Note: All dimensions are nominal.

COMPRESSION FITTINGS

IPS Couplings, Tees & Adapters *(Rated @ 150 PSI Static Pressure @ 72°F)*

PVC Male Adapter



Part No.	Ref. No.	IPS Size UC Connection	IPS Size MPT Connection	Body Length	Color	Pkg. Qty.	Case (lbs.)	Product Class	Specifications
PVC Male Adapter									
CPA-0500	130-05	1/2"	1/2" MPT	3-3/8"	White	48	8.2	42CP	PVC NSF/ANSI 61+372 UPC
CPA-0750	130-07	3/4"	3/4" MPT	4"	White	36	8.2	42CP	
CPA-1000	130-10	1"	1" MPT	4"	White	24	7.0	42CP	
CPA-1250	130-12	1-1/4"	1-1/4" MPT	4-1/8"	White	18	7.3	42CP	
CPA-1500	130-15	1-1/2"	1-1/2" MPT	4-3/8"	White	16	8.2	42CP	
CPA-2000	130-20	2"	2" MPT	4-5/8"	White	12	8.8	42CP	

CTS Couplings & Tees *(Rated @ 150 PSI Static Pressure @ 72°F)*

PVC Couplings



PVC Threaded Tee



Part No.	Ref. No.	CTS Size	IPS Branch	Body Length	Color	Pkg. Qty.	Case (lbs.)	Product Class	Specifications
PVC Couplings									
CCC-0500	210-05	1/2" UC		4"	White	48	5.8	42CP	PVC NSF/ANSI 61+372 UPC
CCC-0750	210-07	3/4" UC		4"	White	30	7.0	42CP	
CCC-1000	210-10	1" UC		5-1/4"	White	24	8.2	42CP	
PVC Threaded Tee									
CCT-0500	220-05	1/2" UC	1/2" FPT	4"	White	36	8.2	42CP	PVC NSF/ANSI 61+372
CCT-1000	220-10	1" UC	1" FPT	5"	White	18	9.1	42CP	
CCT-1250	220-12	1-1/4" UC	1-1/4" FPT	5-1/2"	White	10	7.0	42CP	
CCT-2000	220-20	2" UC	2" FPT	7-1/2"	White	5	8.75	42CP	

Note: All dimensions are nominal.

Wrenches

Stub Wrench



Part No.		Pkg. Qty.	Product Class	Specifications
Stub Wrench				
SW-0500-C	1/2" + 3/4" Plastic Riser Extractor	25	42LS	Steel Handle

FLO-LOCK™

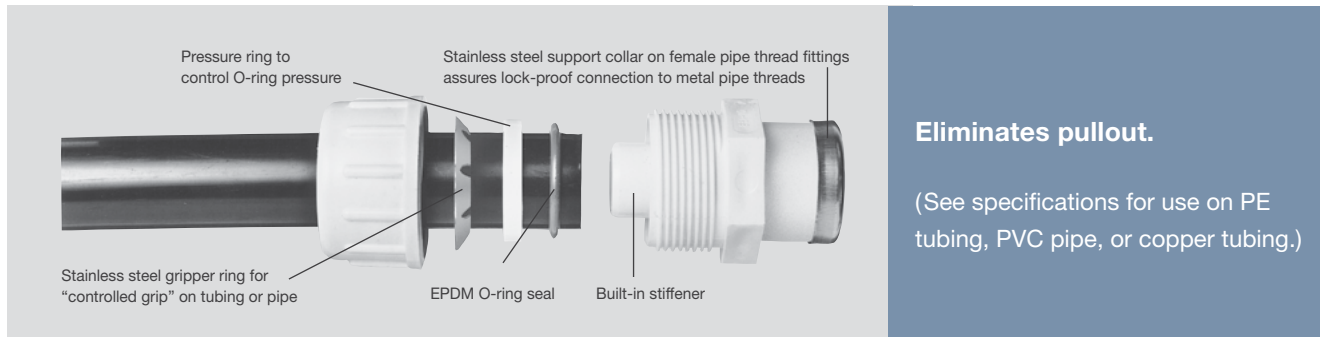

Eliminates pullout.

(See specifications for use on PE tubing, PVC pipe, or copper tubing.)

Tube Size SIDR-7 Pep Couplings & Adapters – Series 800 (Rated @ 200 PSI Static Pressure @ 72°F)

	Part No.	Tube Size	Connection Size	Body Length	Color	Pkg. Qty.	Case (lbs.)	Product Class	Specifications
Coupling	Coupling								
	810-07	3/4"	3/4" x 3/4" TS	4-1/2"	White	24	10.6	41FL	For use on Polyethylene Tube Size SIDR-7
	810-10	1"	1" x 1" TS	5"	White	15	8.5	41FL	ASTM D-2239
Male Adapter	Male Adapter								
	830-07	3/4"	3/4" MPT x 3/4" TS	2-5/8"	White	20	5.0	41FL	For use on Polyethylene Tube Size SIDR-7
	830-10	1"	1" MPT x 1" TS	3-1/4"	White	28	9.4	41FL	ASTM D-2239
	830-71	3/4" x 1"	3/4" MPT x 1" TS	3-1/2"	White	18	5.5	41FL	PVC
	830-121	1" x 1-1/4"	1" MPT x 1-1/4" TS	3"	White	12	4.3	41FL	NSF/ANSI 61+372 UPC 830- 07/10 Only
Female Adapter	Female Adapter								
	831-07	3/4"	3/4" FPT x 3/4" TS	2-5/8"	White	20	6.0	41FL	For use on Polyethylene Tube Size SIDR-7
	831-10	1"	1" FPT x 1" TS	2-7/8"	White	28	10.8	41FL	ASTM D-2239 PVC NSF/ANSI 61+372
Spigot Adapter	Spigot Adapter								
	833-07	3/4"	3/4" IPS Spg x 3/4" TS	3"	White	20	5.0	41FL	For use on Polyethylene Tube Size SIDR-7
	833-71	3/4" x 1"	3/4" IPS Spg x 1" TS	3"	White	20	7.0	41FL	ASTM D-2239
	833-10	1"	1" IPS Spg x 1" TS	3"	White	28	9.4	41FL	PVC NSF/ANSI 61+372 UPC

* Insert stiffener supplied must be used with this fitting.

FLOW MANAGEMENT

FLO-LOCK™

Tube Size SDR-9 CTS Couplings & Adapters – Series 700 (Rated @ 200 PSI Static Pressure @ 72°F)

PVC Couplings

Part No.	Tube Size	Connection	Length Inches	Color	Pkg. Qty.	Case (lbs.)	Product Class	Specifications
PVC Couplings								
710-07	3/4"	3/4" x 3/4" TS	4"	White	35	9.8	41FL	For use on Polyethylene Tube Size SDR-9 ASTM D-2737 PVC NSF/ANSI 61+372 UPC
710-10	1"	1" x 1" TS	4-1/2"	White	24	9.4	41FL	
710-17	3/4" x 1"	1" SDR-9 x 3/4" SDR-11	4"	White	36	11.8	41FL	
710-12	1-1/4"	1-1/4" x 1-1/4" TS	5"	White	15	8.5	41FL	
710-15†	1-1/2"	1-1/2" x 1-1/4" TS	6"	White	16	13.0	41FL	
710-20†	2"	2" x 2" TS	7-1/2"	White	12	15.9	41FL	
710-17-9	3/4" x 1"	1" SDR-9 x 3/4" SDR 9	4"	White	36	11.8	41FL	
Male Adapter								
730-07	3/4"	3/4" MPT x 3/4" TS	2-5/8"	White	25	4.75	41FL	For use on Polyethylene Tube Size SDR-9 ASTM D-2737 PVC UPC except 730-12-10 NSF/ANSI 61+372
730-71	3/4" x 1"	3/4" MPT x 1" TS	2-7/8"	White	18	4.6	41FL	
730-10	1"	1" MPT x 1" TS	2-7/8"	White	18	4.6	41FL	
730-12	1-1/4"	1-1/4" MPT x 1-1/4" TS	3-1/2"	White	12	4.6	41FL	
730-15	1-1/2"	1-1/2" MPT x 1-1/2" TS	3-1/2"	White	18	9.1	41FL	
730-20†	2"	2" MPT x 2" TS	4"	White	12	8.8	41FL	
Female Adapter								
731-07	3/4"	3/4" FPT x 3/4" TS	2-5/8"	White	25	6.0	41FL	For use on Polyethylene Tube Size SDR-9 ASTM D-2737 PVC NSF/ANSI 61+372
731-71	3/4" x 1"	3/4" FPT x 1" TS	2-7/8"	White	15	4.0	41FL	
731-10	1"	1" FPT x 1" TS	3"	White	15	4.8	41FL	
731-12	1-1/4"	1-1/4" FPT x 1-1/4" TS	3-1/2"	White	12	5.2	41FL	
731-12-10	1" x 1-1/4"	1" FPT x 1-1/4" TS	3-1/2"	White	12	5.2	41FL	
731-15	1-1/2"	1-1/2" FPT x 1-1/2" TS	3-1/2"	White	18	10.0	41FL	
731-20†	2"	2" FPT x 2" TS	3-3/4"	White	12	8.2	41FL	
Spigot Adapter								
733-07	3/4"	3/4" IPS Spg x 3/4" TS	2-7/8"	White	18	3.7	41FL	For use on Polyethylene Tube Size SDR-9 ASTM D-2737 PVC NSF/ANSI 61+372 UPC
733-71	3/4"	3/4" IPS Spg x 1" TS	2-7/8"	White	18	4.0	41FL	
733-10	1"	1" IPS Spg x 1" TS	3-1/2"	White	18	4.6	41FL	
733-12	1-1/4"	1-1/4" IPS Spg x 1-1/4" TS	3-1/2"	White	12	5.2	41FL	
733-15	1-1/2"	1-1/2" IPS Spg x 1-1/2" TS	3-1/2"	White	18	9.1	41FL	
733-20†	2"	2" IPS Spg x 2" TS	4"	White	12	7.6	41FL	

† Insert stiffener supplied must be used with this fitting.

Male Adapter

Female Adapter

Spigot Adapter

FLO-LOCK™

Couplings & Adapters – Series 100 - For use on PVC IPS Sizes (Rated @ 160 PSI Static Pressure @ 72°F)

Part No.	IPS Size	Connection	Body Length	Color	Pkg. Qty.	Case (lbs.)	Product Class	Specifications
PVC IPS Coupling with Flo-Lock								
112-05	1/2"		5"	White	28	8.0	41FL	For use on IPS sizes ASTM D-1785 NSF/ANSI 61+372
112-07	3/4"		5-1/2"	White	24	9.4	41FL	
112-10	1"		5-3/4"	White	15	8.5	41FL	
112-12	1-1/4"		6-1/2"	White	10	8.0	41FL	
112-15	1-1/2"		7"	White	16	14.6	41FL	
112-20	2"		7-1/2"	White	12	14.8	41FL	
PVC IPS Male Adapter with Flo-Lock								
135-05	1/2"	1/2" MPT	2-3/4"	White	25	4.8	41FL	For use on IPS sizes ASTM D-1785 NSF/ANSI 61+372 UPC
135-07	3/4"	3/4" MPT	3"	White	20	5.0	41FL	
135-10	1"	1" MPT	3-1/4"	White	30	8.5	41FL	
135-12	1-1/4"	1-1/4" MPT	3-1/2"	White	20	8.0	41FL	
135-15	1-1/2"	1-1/2" MPT	3-1/2"	White	16	7.4	41FL	
135-20	2"	2" MPT	4"	White	12	8.8	41FL	
PVC IPS Female Adapter with Flo-Lock								
136-05	1/2"	1/2" FPT	2-3/4"	White	25	4.8	41FL	For use on IPS sizes ASTM D-1785 NSF/ANSI 61+372
136-07	3/4"	3/4" FPT	3-1/4"	White	20	5.0	41FL	
136-10	1"	1" FPT	3-1/4"	White	14	4.5	41FL	

Adapters – Series 200 & 900 - For use on Copper Tubing CTS Series (Rated @ 160 PSI Static Pressure @ 72°F)

Part No.	CTS Size	Connection	Body Length	Color	Pkg. Qty.	Case (lbs.)	Product Class	Specifications
PVC CTS Male Adapter with Flo-Lock (Rated @ 160 PSI Static Pressure @ 72°F)								
235-05	1/2"	1/2" MPT	2-1/2"	White	50	6.0	41FL	For use on CTS pipe ASTM B88 NSF/ANSI 61+372 UPC Except 235-20
235-07	3/4"	3/4" MPT	2-3/4"	White	25	4.8	41FL	
235-10	1"	1" MPT	3"	White	18	4.6	41FL	
235-12	1-1/4"	1-1/4" MPT	3-1/4"	White	24	7.0	41FL	
235-15	1-1/2"	1-1/2" MPT	3-1/2"	White	20	8.5	41FL	
235-20	2"	2" MPT	4"	White	12	7.6	41FL	
PVC CTS Female Adapter with Flo-Lock								
935-07	3/4"	3/4" Spg	2-7/8"	White	20	4.5	41FL	For use on CTS pipe ASTM B88 NSF/ANSI 61+372
935-10	1"	1" Spg	2-7/8"	White	20	5.0	41FL	
935-12	1-1/4"	1-1/4" Socket	3-5/16"	White	25	8.5	41FL	
935-125	1-1/4"	1-1/2" Socket	3-5/16"	White	20	7.0	41FL	
935-15	1-1/2"	1-1/2" Socket	4"	White	20	10.0	41FL	
935-20	2"	2" Socket	4"	White	12	7.6	41FL	

EXPANSION REPAIR COUPLINGS

Pro-Span™



Part No.	IPS Size	Body Length	Color	Pkg. Qty.	Case (lbs.)	Product Class	Specifications
118-05	1/2" S x SPG	7-1/2"	White	28	6.6	41XC	PVC 118-05 Thru 25: NSF/ANSI 14 UPC Rated @200 PSI Static Pressure @72°F
118-07	3/4" S x SPG	7-3/4"	White	24	8.2	41XC	
118-10	1" S x SPG	9-1/2"	White	15	8.5	41XC	
118-12	1-1/4" S x SPG	10-3/4"	White	10	8.0	41XC	
118-15	1-1/2" S x SPG	12-3/4"	White	16	17.8	41XC	
118-20	2" S x SPG	13-1/2"	White	12	17.8	41XC	
118-25	2-1/2" S x SPG	18-3/4"	White	3	9.55	41XC	
118-30	3" S x SPG	21"	White	3	13.3	41XC	
118-40	4" S x SPG	22-3/4"	White	3	20.5	41XC	
118-60QF	6" S x S	26-1/4"	White	1	13.8	42RF	

QF-6000 IS NOW P/N 118-60QF, AND CARRIES THE SAME SPECIFICATIONS

Rated @150 PSI Static Pressure @72°F

FOOT VALVES (SPRING CHECK)

Foot Valve



Foot Valve Screens



Part No.	IPS Size	Body Length	Color	Pkg. Qty.	Case (lbs.)	Product Class	Specifications
Foot Valve							
1001-10FV	1"	7"	White	20	9.0	41CV	PVC Rated @ 200 PSI @ 72°F
1001-12FV	1-1/4"	8"	White	15	13.0	41CV	
1001-15FV	1-1/2"	8-1/2"	White	15	13.8	41CV	
1001-20FV	2"	10-1/2"	White	10	16.0	41CV	
Foot Valve Screens							
1800-07	3/4"	2"	Black	24	1.5	41CV	Material: Polyethylene 100 mesh
1800-10	1"	2"	Black	15	1.6	41CV	
1800-12	1-1/4"	2-1/4"	Black	10	1.5	41CV	
1800-15	1-1/2"	2"	Black	16	2.0	41CV	
1800-20	2"	2-3/4"	Black	12	2.2	41CV	

SPRING CHECK VALVES

Spring Check Valves – PVC – Series 1001, 1002, 1011, 1012 (Rated @ 200 PSI Static Pressure @ 72°F)

FPT x FPT
EPDM Gasket



S x S
EPDM Gasket



S x S Clear
PVC EPDM
Gasket



Part No.	Ref. No.	Spring Tension	IPS Size Connection	Body Length	Color	Pkg. Qty.	Case (lbs.)	Product Class	Specifications
FPT x FPT EPDM Gasket									
1001-05	KC-0500-T	1/2 lb.	1/2"	4-1/8"	White	20	5.0	41CV	PVC NSF/ANSI 61+372
1001-07	KC-0750-T	1/2 lb.	3/4"	4-1/8"	White	20	6.0	41CV	
1001-10	KC-1000-T	1/2 lb.	1"	5-1/4"	White	20	8.0	41CV	
1001-12	KC-1250-T	1/2 lb.	1-1/4"	6-3/16"	White	15	13.0	41CV	
1001-15	KC-1500-T	1/2 lb.	1-1/2"	6-3/16"	White	15	13.8	41CV	
1001-20	KC-2000-T	1/2 lb.	2"	7-1/2"	White	10	15.0	41CV	
1001-25		1/2 lb.	2-1/2"	8-5/8"	White	8	27.0	41CV	
1001-30		1/2 lb.	3"	8-5/8"	White	8	27.4	41CV	
1002-05		2 lb.	1/2"	4-1/8"	White	20	5.0	41CV	
1002-07	KC2-0750-T	2 lb.	3/4"	4-1/8"	White	20	6.0	41CV	
1002-10	KC2-1000-T	2 lb.	1"	5-1/4"	White	20	8.0	41CV	
1002-12	KC2-1250-T	2 lb.	1-1/4"	6-3/16"	White	15	13.0	41CV	
1002-15	KC2-1500-T	2 lb.	1-1/2"	6-3/16"	White	15	13.8	41CV	
1002-20	KC2-2000-T	2 lb.	2"	7-1/2"	White	10	15.0	41CV	
1002-25		2 lb.	2-1/2"	8-5/8"	White	8	27.0	41CV	
1002-30		2 lb.	3"	8-5/8"	White	8	27.4	41CV	
S x S EPDM Gasket									
1011-05-025		1/4 lb.	1/2"	4-1/8"	White	20	5.0	41CV	PVC NSF/ANSI 61+372
1011-07-025		1/4 lb.	3/4"	4-1/8"	White	20	5.0	41CV	
1011-05	KC-0500-S	1/2 lb.	1/2"	4-1/8"	White	20	5.0	41CV	
1011-07	KC-0750-S	1/2 lb.	3/4"	4-1/8"	White	20	5.0	41CV	
1011-10	KC-1000-S	1/2 lb.	1"	5-1/4"	White	20	9.0	41CV	
1011-12	KC-1250-S	1/2 lb.	1-1/4"	6-3/16"	White	15	12.3	41CV	
1011-15	KC-1500-S	1/2 lb.	1-1/2"	6-1/2"	White	15	13.0	41CV	
1011-20	KC-2000-S	1/2 lb.	2"	7"	White	10	14.5	41CV	
1011-25		1/2 lb.	2-1/2"	8-5/8"	White	8	25.8	41CV	
1011-30		1/2 lb.	3"	8-5/8"	White	8	25.4	41CV	
1012-05	KC2-0500-S	2 lb.	1/2"	4-1/8"	White	20	5.0	41CV	
1012-07	KC2-0750-S	2 lb.	3/4"	4-1/8"	White	20	5.0	41CV	
1012-10	KC2-1000-S	2 lb.	1"	5-1/4"	White	20	9.0	41CV	
1012-12	KC2-1250-S	2 lb.	1-1/4"	6-3/16"	White	15	12.3	41CV	
1012-15	KC2-1500-S	2 lb.	1-1/2"	6-1/2"	White	15	13.0	41CV	
1012-20	KC2-2000-S	2 lb.	2"	7"	White	10	14.5	41CV	
1012-25		2 lb.	2-1/2"	8-5/8"	White	8	25.8	41CV	
1012-30		2 lb.	3"	8-5/8"	White	8	25.4	41CV	
1015-25		5 lb.	2-1/2"	8-5/8"	White	8	25.8	41CV	
S x S Clear PVC EPDM Gasket									
1011C10	KCC-1000-S	1/2 lb.	1"	5-1/4"	Clear	20	8.0	41CV	Clear PVC NSF/ANSI 61+372
1011C12	KCC-1250-S	1/2 lb.	1-1/4"	6-3/16"	Clear	15	12.3	41CV	
1011C15	KCC-1500-S	1/2 lb.	1-1/2"	6-1/2"	Clear	15	13.0	41CV	
1011C20	KCC-2000-S	1/2 lb.	2"	7"	Clear	10	14.0	41CV	

SPRING CHECK VALVES

Spring Check Valves – PVC – Series 1700, 1090, 1136 *(Rated @ 200 PSI Static Pressure @ 72°F)*

White PVC True Union



Clear PVC True Union



Compact White PVC True Union



Compact Clear PVC True Union



CPVC 90°



Inline Valve and Bypass Valve



Hose Thread (EPDM Gasket)



Part No.	Spring Tension	IPS Size & Connection	Body Length	Color	Pkg. Qty.	Case (lbs.)	Product Class	Specifications
White PVC True Union								
1700-07	1/2 lb.	3/4" S x S	6-1/4"	White	20	10.0	41CV	Rated @ 200 PSI Static Pressure @ 72°F NSF/ANSI 61+372
1700-10	1/2 lb.	1" S x S	6-3/4"	White	20	14.0	41CV	
1700-15	1/2 lb.	1-1/2" S x S	8-1/4"	White	12	15.4	41CV	
1700-20	1/2 lb.	2" S x S	9-3/4"	White	12	25.6	41CV	
1702-15	2 lb.	1-1/2" S x S	8-1/4"	White	12	15.4	41CV	
1702-20	2 lb.	2" S x S	9-3/4"	White	12	25.6	41CV	
Clear PVC True Union								
1700C07	1/2 lb.	3/4" S x S	6-1/4"	Clear	20	10.0	41CV	Clear body with white nut and tailpiece Rated @ 200 PSI Static Pressure @ 72°F NSF/ANSI 61+372
1700C10	1/2 lb.	1" S x S	6-3/4"	Clear	20	14.0	41CV	
1700C15	1/2 lb.	1-1/2" S x S	8-1/4"	Clear	12	15.4	41CV	
1700C20	1/2 lb.	2" S x S	9-3/4"	Clear	12	25.6	41CV	
1700C30	1/2 lb.	3" S x S	13-1/4"	Clear	6	28.3	41CV	
1702C15	2 lb.	1-1/2" S x S	8-1/4"	Clear	12	15.4	41CV	
1702C20	2 lb.	2" S x S	9-3/4"	Clear	12	25.6	41CV	
Compact White PVC True Union								
1790-15	1/2 lb.	1-1/2" S x S	6-1/2"	White	15	13.8	41CV	Rated @ 200 PSI Static Pressure @ 72°F NSF/ANSI 61+372
1790-20	1/2 lb.	2" S x S	7-3/8"	White	10	14.0	41CV	
Compact Clear PVC True Union								
1790C15	1/2 lb.	1-1/2" S x S	6-1/2"	Clear	15	13.8	41CV	Rated @ 200 PSI Static Pressure @ 72°F Clear body with white nut and tailpiece
1790C20	1/2 lb.	2" S x S	7-3/8"	Clear	10	14.0	41CV	
1795C20	5 lb.	2" S x S	7-3/8"	Clear	10	14.0	41CV	
CPVC 90°								
1901-15	1 lb.	1-1/2" S x S	5"	Tan	12	8.8	41CV	Rated @ 125 PSI Static Pressure @ 160°F
1903-15	3 lb.	1-1/2" S x S	5"	Tan	12	8.8	41CV	
Inline Valve and Bypass Valve								
1095-20	5 lb.	2" S x S	5"	White	12	6.9	41CV	Non-Adjustable EPDM Seal Rated @ 200 PSI Static Pressure @ 72°F NSF/ANSI 61+372
Hose Thread (EPDM Gasket)								
1136-07	1/2 lb.	3/4" MHT x 3/4" FHT	4-1/8"	White	20	5.0	41CV	Rated @ 200 PSI Static Pressure @ 72°F NSF/ANSI 61+372
1136-07-05	5 lb.	3/4" MHT x 3/4" FHT	4-1/8"	White	20	5.0	41CV	

SPRING CHECK VALVES

Spa Spring Check Valves

Part No.	Spring Tension	IPS Size & Connection	Body Length	Color	Pkg. Qty.	Case (lbs.)	Product Class	Specifications	
Clear Spa Check Valve									
1050C10	1/4 lb.	1" S x 1-1/4" Spg	3-3/8"	Clear	20	5.0	41CV	Clear PVC 1/4 lb. for air blowers Rated @ 200 PSI Static Pressure @ 72°F UL Listed	
1050C20	1/4 lb.	1-1/2" S x 2" Spg	5-1/8"	Clear	12	7.6	41CV		
1050C20-05	1/2 lb.	1-1/2" S x 2" Spg	5-1/8"	Clear	12	7.6	41CV		
1050C20-10	10 lb.	1-1/2" S x 2" Spg	5-1/8"	Clear	12	7.6	41CV		
1050C20-12	12 lb.	1-1/2" S x 2" Spg	5-1/8"	Clear	12	7.6	41CV		
1050C20-15	15 lb.	1-1/2" S x 2" Spg	5-1/8"	Clear	12	7.6	41CV		
1053C20	3 lb.	1-1/2" S x 2" Spg	5-1/8"	Clear	12	7.6	41CV		
1055C20	5 lb.	1-1/2" S x 2" Spg	5-1/8"	Clear	12	7.6	41CV		
Clear Compact									
S1050C20	1/4 lb.	1-1/2" S x 2" Spg	4"	Clear	12	6	41CV		Clear PVC 1/4 lb. for air blowers Rated @ 200 PSI Static Pressure @ 72°F
S1050C20-05	1/2 lb.	1-1/2" S x 2" Spg	4"	Clear	12	6	41CV		
S1052C20	2 lb.	1-1/2" S x 2" Spg	4"	Clear	12	6	41CV		

Clear Spa Check Valve



Clear Compact



Adjustable Spring Check Valves – Series 1200, 1700 *(Rated @ 200 PSI Static Pressure @ 72°F)*

Part No.	Spring Tension	IPS Size & Connection	Body Length	Color	Pkg. Qty.	Case (lbs.)	Product Class	Specifications	
White PVC FPT x FPT									
Factory Set at 5 lb.									
1205-05	2 – 5 lb.	1/2"	4-1/8"	White	20	5.0	41CV	Adjusting nut 1-1/2 turn = 1 lb. force NSF/ANSI 61+372 Except: 1205V07	
1205-07	2-1/2 – 5 lb.	3/4"	4-1/8"	White	20	5.0	41CV		
1205-10	4-1/8 – 17 lb.	1"	5-1/4"	White	20	9.0	41CV		
1205-12	4 – 50 lb.	1-1/4"	6-3/16"	White	15	12.3	41CV		
1205-15	3-1/2 – 50 lb.	1-1/2"	6-3/16"	White	15	12.3	41CV		
1205-20	1-3/4 – 14-1/2 lb.	2"	7-1/2"	White	10	15.5	41CV		
1205-07-20	20 lb.	3/4"	4-1/8"	White	20	5.0	41CV		
1205V07	5 lb.	3/4" w/VITON	4-1/8"	White	20	5.0	41CV		
White PVC S x S									
1225-07	2-1/2 – 5 lb.	3/4"	4-1/8"	White	20	4.5	41CV		Adjusting nut 1-1/2 turn = 1 lb. force NSF/ANSI 61+372 Except: 1228V15
1225-10	4-1/4 – 17 lb.	1"	5-1/4"	White	20	8.5	41CV		
1225-15	3-1/2 – 50 lb.	1-1/2"	6-3/16"	White	15	13.5	41CV		
1228V15	30 lb.	1-1/2"	6-3/16" w/VITON	White	15	12.5	41CV		

White PVC FPT x FPT

Factory Set at 5 lb.



White PVC S x S



SPRING CHECK VALVES

White PVC
FPT x MPT



Part No.	Spring Tension	IPS Size	Body Length	Color	Pkg. Qty.	Case (lbs.)	Product Class	Specifications
White PVC FPT x MPT								
1235-05	2 – 4-1/2 lb.	1/2"	4-1/8"	White	20	4.5	41CV	PVC. Adjusting nut 1-1/2 turn = 1 lb. force NSF/ANSI 61+372
1235-07	2-1/2 – 5 lb.	3/4"	4-1/8"	White	20	4.5	41CV	
1235-10	4-1/4 – 17 lb.	1"	5-1/4"	White	20	8.5	41CV	
1235-05-30	30 lb.	1/2"	4-1/8"	White	20	4.5	41CV	

Adjustable Inline Spring Check Valve

FF



FM



MF



UCV



Part No.	Ref. No.	IPS Size & Connection	Body Length	Pkg. Qty.	Case (lbs.)	Product Class	Specifications
Gray PVC							
CV-0500-FF	1100-05	1/2" FPT x FPT	2-3/4"	100	11.0	41CV	Preset @ approx. 5 lb. with EPDM Seal. Adjusting nut 1-1/2 turn = 1 lb. force
CV-0500-FM		1/2" FPT x MPT	2-1/2"	100	11.0	41CV	
CV-0500-MF	1101-05	1/2" MPT x FPT	2-3/4"	100	11.0	41CV	
CV-0575-FM		1/2" FPT x 3/4" MPT	2-1/2"	100	13.0	41CV	
CV-0750-FF	1100-07	3/4" FPT x FPT	3"	60	8.2	41CV	
CV-0750-FM	1102-07	3/4" FPT x MPT	2-7/8"	60	8.2	41CV	
CV-0750-MF	1101-07	3/4" MPT x FPT	2-7/8"	60	8.2	41CV	
CV-1000-FF	1100-10	1" FPT x FPT	3"	40	9.0	41CV	
CV-1000-FM		1" FPT x MPT	3"	40	7.0	41CV	
CV-1000-MF		1" MPT x FPT	3"	40	7.0	41CV	
UV Resistant Tan PVC							
UCV-0500-MF		1/2" MPT x FPT	2-3/4"	100	11.0	41CV	UV Resistant PVC
UCV-0750-MF		3/4" MPT x FPT	2-7/8"	60	8.2	41CV	
UCV-1000-FF		1" FTP x FPT	3"	40	9.0	41CV	

FLOW MANAGEMENT

Breakaway Coupling Valves

Flo-Check
Breakaway
Coupling —
Cal Trans
Orange



Part No.	IPS Size & Connection	Body Length	Color	Pkg. Qty.	Case (lbs.)	Product Class	Specifications
Flo-Check Breakaway Coupling – Cal Trans Orange							
1010-05-0	1/2" FPT x 1/2" FPT	2-1/4"	Orange	30	2.5	41CV	Rated @ 150 PSI Static Pressure @ 72°F
1010-07-0	3/4" FPT x 3/4" FPT	2-3/8"	Orange	25	3.5	41CV	

Note: To be used on galvanized or iron pipe only.

SWING CHECK VALVES

Swing Check Valves – Series 1500 *(Rated @ 125 PSI Static Pressure @ 72°F)*

	Part No.	Ref. No.	IPS Size & Connection	Body Length	Color	Pkg. Qty.	Case (lbs.)	Product Class	Specifications
 <p>White PVC Compression</p>	White PVC Compression								
	1500-12	KSC-1250-C	1-1/4" UC x UC	8-1/2"	White	12	13.6	41CV	NSF/ANSI 61+372
	1500-15	KSC-1500-C	1-1/2" UC x UC	8-1/2"	White	12	14.2	41CV	
	1500-20	KSC-2000-C	2" UC x UC	9-1/2"	White	12	20.8	41CV	
1500-30	KSC-3000-C	3" UC x UC	13-3/8"	White	2	10.1	41CV		
 <p>Clear PVC Compression</p>	Clear PVC Compression								
	1500C15	KSCC-1500-C	1-1/2" UC x UC	8-1/2"	Clear	12	14.2	41CV	Clear PVC with white CAPS NFS/ANSI 61+372
1500C20	KSCC-2000-C	2" UC x UC	9-31/2"	Clear	12	20.8	41CV		
 <p>White PVC Threaded</p>	White PVC Threaded								
	1520-05F	KSC-0500-T	1/2" FPT x FPT	3-1/2"	White	20	4.0	41CV	PVC NSF/ANSI 61+372
	1520-07F	KSC-0750-T	3/4" FPT x FPT	3-1/2"	White	25	6.0	41CV	
	1520-10F	KSC-1000-T	1" FPT x FPT	5-1/8"	White	25	9.8	41CV	
	1520-12F	KSC-1250-T	1-1/4" FPT x FPT	5-1/4"	White	12	7.6	41CV	
	1520-15F	KSC-1500-T	1-1/2" FPT x FPT	5-3/4"	White	12	8.2	41CV	
1520-20F	KSC-2000-T	2" FPT x FPT	6"	White	12	12.4	41CV		
 <p>White PVC S x S</p>	White PVC S x S								
	1520-05	KSC-0500-S	1/2" S x S	3-1/2"	White	20	4.0	41CV	PVC NSF/ANSI 61+372 Except: 1520V20
	1520-07	KSC-0750-S	3/4" S x S	3-1/2"	White	25	6.0	41CV	
	1520-10	KSC-1000-S	1" S x S	5-1/8"	White	25	9.8	41CV	
	1520-12	KSC-1250-S	1-1/4" S x S	5-1/4"	White	12	7.6	41CV	
	1520-15	KSC-1500-S	1-1/2" S x S	5-3/4"	White	12	8.2	41CV	
	1520-20	KSC-2000-S	2" S x S	6"	White	12	12.4	41CV	
	1520-30		3" S x S	9"	White	4	11.0	41CV	
	1520-40		4" S x S	9-1/2"	White	1	4.3	41CV	
	1520V20		2" S x S w/ VITON Seal	6"	White	12	12.4	41CV	
 <p>Clear PVC Threaded</p>	Clear PVC Threaded								
	1520C05F	KSCC-0500-T	1/2" FPT x FPT	3-1/2"	Clear	20	4.0	41CV	Clear PVC NSF/ANSI 61+372
	1520C07F	KSCC-0750-T	3/4" FPT x FPT	3-1/2"	Clear	25	6.0	41CV	
	1520C10F	KSCC-1000-T	1" FPT x FPT	5-1/8"	Clear	25	9.8	41CV	
	1520C15F	KSCC-1500-T	1-1/2" FPT x FPT	5-3/4"	Clear	12	7.6	41CV	
	1520C15FV	KSCC-1500-T	1-1/2" FPT x FPT	5-3/4"	Clear	12	7.0	41CV	
	1520C20F	KSCC-2000-T	2" FPT x FPT	6"	Clear	12	8.2	41CV	
1520C20V		2" S x S w/ VITON Seal	6"	Clear	12	12.4	41CV		
 <p>Clear PVC S x S</p>	Clear PVC S x S								
	1520C05	KSCC-0500-S	1/2" S x S	3-1/2"	Clear	20	4.0	41CV	Clear PVC NSF/ANSI 61+372 Except 1520C15V, 1520C20V
	1520C07	KSCC-0750-S	3/4" S x S	3-1/2"	Clear	25	6.0	41CV	
	1520C10	KSCC-1000-S	1" S x S	5-1/8"	Clear	25	9.8	41CV	
	1520C12	KSCC-1250-S	1-1/4" S x S	5-1/4"	Clear	12	7.6	41CV	
	1520C15	KSCC-1500-S	1-1/2" S x S	5-3/4"	Clear	12	8.2	41CV	
	1520C20	KSCC-2000-S	2" S x S	6"	Clear	12	12.4	41CV	
	1520C30		3" S x S	9"	Clear	4	11.0	41CV	
	1520C40		4" S x S	9-1/2"	Clear	1	4.3	41CV	
	1520C15V		1-1/2" S x S w/ VITON Seal	5-3/4"	Clear	12	8.2	41CV	

SWING CHECK VALVES

Swing Check Valves – Series 1700 & Low-Profile (Rated @ 125 PSI Static Pressure @ 72°F)

White PVC True Union



Clear PVC True Union



PVC Low-Profile Swing Check Valve



Part No.	Ref. No.	IPS Size & Connection	Body Length	Color	Pkg. Qty.	Case (lbs.)	Product Class	Specifications
White PVC True Union								
1720-07		3/4" U x U	5-1/2"	White	20	10.0	41CV	PVC NSF/ANSI 61+372
1720-10		1" U x U	6-7/8"	White	20	15.0	41CV	
1720-15	KSC-1500-SU	1-1/2" U x U	8"	White	12	14.2	41CV	
1720-20	KSC-2000-SU	2" U x U	9-5/8"	White	12	22.6	41CV	
1720-30	KSC-3000-SU	3" U x U	13-1/4"	White	6	24.7	41CV	
Clear PVC True Union								
1720C07	KSCC-0750-SU	3/4" U x U	5-1/2"	Clear	20	10.0	41CV	PVC Clear body with white nuts and tailpieces NSF/ANSI 61+372
1720C10	KSCC-1000-SU	1" U x U	6-7/8"	Clear	20	15.0	41CV	
1720C15	KSCC-1500-SU	1-1/2" U x U	8"	Clear	12	14.2	41CV	
1720C20	KSCC-2000-SU	2" U x U	9-5/8"	Clear	12	22.6	41CV	
1720C30	KSCC-3000-SU	3" U x U	13-1/4"	Clear	6	24.7	41CV	
PVC Low-Profile Swing Check Valve								
KSL-0750-S		3/4"	5"	White	18	8.2	41CV	PVC NSF/ANSI 61+372
KSL-1000-S		1"	4-3/4"	White	18	7.3	41CV	
KSL-1250-S		1-1/4"	5-1/4"	White	12	8.2	41CV	
KSL-1500-S		1-1/2"	5-1/2"	White	12	8.8	41CV	
KSL-2000-S		2"	6-1/2"	White	8	8.2	41CV	

Sump Pump Valves (Rated @ 125 PSI Static Pressure @ 72°F)

Sump Pump Valve



Part No.	Ref. No.	IPS Size & Connection	Body Length	Check Valve Color	Pkg. Qty.	Case (lbs.)	Product Class	Specifications
Sump Pump Valve								
1400-15		1-1/4" or 1-1/2" UC	5-1/4"	White	12	7.6	41CV	Buna "N" Gaskets are included in both 1-1/4" and 1-1/2" size applications

Checkmate (Rated @ 125 PSI Static Pressure @ 72°F)

U x S



U x U



UC x UC

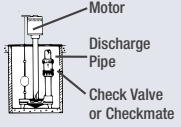

Part No.	Ref. No.	IPS Size & Connection	Body Length	Check Valve Color	Pkg. Qty.	Case (lbs.)	Product Class	Specifications
Checkmate								
2200-15	BCX-1500-S	1-1/2" U x S	8"	White	12	19.6	41BV	
2200-15UC		1-1/2" UC x UC	10-3/4"	White	12	24.4	41BV	
2200-15TU		1-1/2" U x U	10-1/2"	White	12	25.6	41BV	
2200-20	BCX-2000-S	2" U x S	9-3/8"	White	12	28.0	41BV	
2200C20TU		2" U x U	12-3/8"	Clear	12	37.0	41BV	
2200-20UC		2" UC x UC	12-5/16"	White	12	35.8	41BV	
2200-20TU		2" U x U	12-3/8"	White	12	37.0	41BV	

MIP (MOLDED-IN-PLACE) BALL VALVES (Rated @ 150 PSI Static Pressure @ 72°F)

MIP
Non-Serviceable
WHITE
1/2" - 2"



MIP
Non-Serviceable
WHITE
2-1/2" - 4"



MIP
Non-Serviceable
(NSF) WHITE
1/2" - 2"



MIP
Non-Serviceable
(NSF) WHITE
2-1/2" - 4"



Part No.	IPS Size & Connection	Body Length	Color	Pkg. Qty.	Case (lbs.)	Product Class
MIP Non-Serviceable WHITE						
E1310-05	1/2" S x S	3-1/4"	White	36	6.4	41MV
E1310-07	3/4" S x S	3-3/4"	White	18	5.5	41MV
E1310-10	1" S x S	4-1/4"	White	25	11.0	41MV
E1310-12	1-1/4" S x S	4-1/2"	White	12	9.4	41MV
E1310-15	1-1/2" S x S	5-1/4"	White	12	10.0	41MV
E1310-20	2" S x S	5-3/4"	White	6	7.9	41MV
E1310-25	2-1/2" S x S	7"	White	6	19.3	41MV
E1310-30	3" S x S	8-1/2"	White	2	8.8	41MV
E1310-40	4" S x S	11-1/2"	White	1	20.0	41MV
E1310-60	6" S x S	16"	White	1	22.3	41MV
E1320-05	1/2" FPT x FPT	3-1/4"	White	36	6.4	41MV
E1320-07	3/4" FPT x FPT	3-1/4"	White	18	5.5	41MV
E1320-10	1" FPT x FPT	4-1/4"	White	25	11.0	41MV
E1320-12	1-1/4" FPT x FPT	4-1/4"	White	12	9.4	41MV
E1320-15	1-1/2" FPT x FPT	5-1/2"	White	12	10.0	41MV
E1320-20	2" FPT x FPT	5-3/4"	White	6	7.9	41MV
E1320-25	2-1/2" FPT x FPT	7"	White	6	19.3	41MV
E1320-30	3" FPT x FPT	8-1/2"	White	2	8.8	41MV
E1320-40	4" FPT x FPT	11-1/2"	White	1	10.0	41MV
Part No.	IPS Size & Connection	Body Length	Color	Pkg. Qty.	Case (lbs.)	Product Class
MIP Non-Serviceable (NSF) WHITE						
E1410-05	1/2" NSF S x S	3-1/4"	White	36	6.5	41MV
E1410-07	3/4" NSF S x S	3-3/4"	White	18	5.9	41MV
E1410-10	1" NSF S x S	4-1/4"	White	25	12.4	41MV
E1410-12	1-1/4" NSF S x S	4-1/2"	White	12	7.6	41MV
E1410-15	1-1/2" NSF S x S	5-1/4"	White	12	11.6	41MV
E1410-20	2" NSF S x S	5-3/4"	White	6	9.6	41MV
E1410-25	2-1/2" NSF S x S	7"	White	6	15	41MV
E1410-30	3" NSF S x S	8-1/2"	White	2	12.8	41MV
E1410-40	4" NSF S x S	9"	White	1	9.9	41MV
E1420-05	1/2" NSF FPT x FPT	3-1/4"	White	36	6.7	41MV
E1420-07	3/4" NSF FPT x FPT	3-1/4"	White	18	6.1	41MV
E1420-10	1" NSF FPT x FPT	4-1/4"	White	25	13	41MV
E1420-12	1-1/4" NSF FPT x FPT	4-1/4"	White	12	8	41MV
E1420-15	1-1/2" NSF FPT x FPT	5-1/2"	White	12	12	41MV
E1420-20	2" NSF FPT x FPT	5-3/4"	White	6	10	41MV
E1420-25	2-1/2" NSF FPT x FPT	7"	White	6	15.5	41MV
E1420-30	3" NSF FPT x FPT	8-1/2"	White	2	13.5	41MV
E1420-40	4" NSF FPT x FPT	9"	White	1	10.8	41MV

MIP (MOLDED-IN-PLACE) BALL VALVES (Rated @ 150 PSI Static Pressure @ 72°F)

MIP
Non-Serviceable
GRAY



Part No.	IPS Size & Connection	Body Length	Color	Pkg. Qty.	Case (lbs.)	Product Class
MIP Non-Serviceable GRAY						
E1610-05	1/2" S x S	3-1/4"	Gray	36	6.4	41MV
E1610-07	3/4" S x S	3-3/4"	Gray	18	5.5	41MV
E1610-10	1" S x S	4-1/4"	Gray	25	11.0	41MV
E1610-12	1-1/4" S x S	4-1/2"	Gray	12	9.4	41MV
E1610-15	1-1/2" S x S	5-1/4"	Gray	12	10.0	41MV
E1610-20	2" S x S	5-3/4"	Gray	6	7.9	41MV
E1610-60	6" S x S	16"	Gray	1	22.3	41MV
E1620-05	1/2" FPT x FPT	3-1/4"	Gray	36	6.4	41MV
E1620-07	3/4" FPT x FPT	3-1/4"	Gray	18	5.5	41MV
E1620-10	1" FPT x FPT	4-1/4"	Gray	25	11.0	41MV
E1620-12	1-1/4" FPT x FPT	4-1/4"	Gray	12	9.4	41MV
E1620-15	1-1/2" FPT x FPT	5-1/2"	Gray	12	10.0	41MV
E1620-20	2" FPT x FPT	5-3/4"	Gray	6	7.9	41MV

TRUE UNION BALL VALVES

PVC Sch. 80
True Union
Serviceable



Part No.	IPS Size & Connection	Body Length	Pkg. Qty.	Case (lbs.)	Product Class	Specifications
PVC Sch. 80 True Union Serviceable						
BTU-0750-E	3/4" EPDM Slip & Threaded	4-3/4"	10	7.5	42BV	Connection in both slip & threaded included Rated @ 150 PSI Static Pressure @ 72°F
BTU-1000-E	1" EPDM Slip & Threaded	5-1/4"	8	8.6	42BV	
BTU-1250-E	1-1/4" EPDM Slip & Threaded	6"	4	7.6	42BV	
BTU-1500-E	1-1/2" EPDM Slip & Threaded	6-1/4"	4	7.8	42BV	
BTU-2000-E	2" EPDM Slip & Threaded	7"	2	6.0	42BV	
BTU-2500-SE	2-1/2" SLIP EPDM	11"	1	11.0	42BV	
BTU-2500-TE	2-1/2" FPT EPDM	11"	1	11.0	42BV	
BTU-3000-SE	3" SLIP EPDM	11"	1	11.4	42BV	
PVC Sch. 80 True Union Handles						
BTU-0500-HL	1/2" Red Blocked True Union Handle	N/A	N/A	N/A	96MC	
BTU-0750-HL	3/4" Red Blocked True Union Handle	N/A	N/A	N/A	96MC	
BTU-1000-HL	1" Red Blocked True Union Handle	N/A	N/A	N/A	96MC	
BTU-1250-HL	1-1/4" Red Blocked True Union Handle	N/A	N/A	N/A	96MC	
BTU-1500-HL	1-1/2" Red Blocked True Union Handle	N/A	N/A	N/A	96MC	
BTU-2000-HL	2" Red Blocked True Union Handle	N/A	N/A	N/A	96MC	

PVC Sch. 80
True Union
Handles









CPVC CTS BALL VALVES

CPVC CTS
Ball Valve
TAN



Part No.	IPS Size & Connection	Body Length	Pkg. Qty.	Case (lbs.)	Product Class	Specifications
CPVC CTS Ball Valve TAN						
C1310-05	1/2" CTS S x S	3-1/4"	25	6.0	41MV	
C1310-07	3/4" CTS S x S	4"	25	7.0	41MV	
C1310-10	1" CTS S x S	4-1/4"	25	11.0	41MV	
C1310-12	1-1/4" CTS S x S	4-1/2"	25	14.0	41MV	
C1310-15	1-1/2" CTS S x S	5-1/2"	25	14.0	41MV	
C1310-20	2" CTS S x S	6"	15	18.0	41MV	

PVC UNIONS SCH. 80

	Part No.	IPS Size & Connection	Body Length	Color	Pkg. Qty.	Case (lbs.)	Product Class	Specifications	
 <p>Sch. 80 Union SLIP x SLIP</p>	Sch. 80 Union SLIP x SLIP								
	U-0500-S	1/2" PVC Sch. 80 Union Slip	2"	Gray	48	5.8	42UN	PVC Rated @ 150 PSI @ 72°F NSF/ANSI 61+372 (Except Viton) UPC (1/2-2" Slip Only)	
	U-0750-S	3/4" PVC Sch. 80 Union Slip	2-1/2"	Gray	24	5.8	42UN		
	U-1000-S	1" PVC Sch. 80 Union Slip	2-3/4"	Gray	18	5.5	42UN		
	U-1250-S	1-1/4" PVC Sch. 80 Union Slip	3-1/4"	Gray	12	5.8	42UN		
	U-1500-S	1-1/2" PVC Sch. 80 Union Slip	3-3/4"	Gray	12	8.2	42UN		
	U-2000-S	2" PVC Sch. 80 Union Slip	4"	Gray	6	6.1	42UN		
	U-2500-S	2-1/2" Gray PVC Union Slip	5"	Gray	4	6.8	42UN		
	U-3000-S	3" Gray PVC Union Slip	6"	Gray	2	5.0	42UN		
	U-4000-S	4" Gray PVC Union Slip	7-1/4"	Gray	2	7.6	42UN		
 <p>Sch. 80 Union FPT x FPT</p>	Sch. 80 Union FPT x FPT								
	U-0500-T	1/2" PVC Sch. 80 Union/Threaded	2"	Gray	48	5.8	42UN		
	U-0750-T	3/4" PVC Sch. 80 Union/Threaded	2-1/2"	Gray	24	5.8	42UN		
	U-1000-T	1" PVC Sch. 80 Union/Threaded	2-3/4"	Gray	18	5.5	42UN		
	U-1250-T	1-1/4" PVC Sch. 80 Union/Threaded	3-1/4"	Gray	12	5.8	42UN		
	U-1500-T	1-1/2" PVC Sch. 80 Union/Threaded	3-3/4"	Gray	12	8.2	42UN		
	U-2000-T	2" PVC Sch. 80 Union/Threaded	4"	Gray	6	6.1	42UN		
	U-2500-T	2-1/2" Gray PVC Threaded Union	5"	Gray	4	6.8	42UN		
	U-3000-T	3" Gray PVC Threaded Union	6"	Gray	2	5.0	42UN		
	U-4000-T	4" Gray PVC Threaded Union	7-1/4"	Gray	2	7.6	42UN		
 <p>Sch. 80 Union SLIP x MPT</p>	Sch. 80 Union SLIP x MPT								
	U-0500-SM	1/2" Sch. 80 Union SLIP x MIPT	3"	Gray	48	8.2	42UN		
	U-0750-SM	3/4" Sch. 80 Union SLIP x MIPT	3-1/2"	Gray	24	8.2	42UN		
	U-1000-SM	1" Sch. 80 Union SLIP x MIPT	4"	Gray	18	8.2	42UN		
	U-1250-SM	1-1/4" Sch. 80 Union SLIP x MIPT	4-1/2"	Gray	12	7.0	42UN		
	U-1500-SM	1-1/2" Sch. 80 Union SLIP x MIPT	6-3/4"	Gray	8	6.6	42UN		
 <p>Sch. 80 Union SLIP x FPT</p>	Sch. 80 Union SLIP x FPT								
	U-0500-ST	1/2" Sch. 80 Union SLIP x FIPT	2"	Gray	48	4.8	42UN		
	U-1000-ST	1" Sch. 80 Union SLIP x FIPT	2-3/4"	Gray	18	4.5	42UN		
	U-1500-ST	1-1/2" Sch. 80 Union SLIP x FIPT	3-3/4"	Gray	8	4.8	42UN		
	U-2000-ST	2" Sch. 80 Union SLIP x FIPT	4"	Gray	6	5.1	42UN		
 <p>Sch. 80 Union FPT x MPT</p>	Sch. 80 Union FPT x MPT								
	U-1000-TM	1" Sch. 80 Union FIPT x MIPT	4"	Gray	18	8.2	42UN		
 <p>Sch. 80 Union SLIP x SLIP Viton O-Ring</p>	Sch. 80 Union SLIP x SLIP Viton O-Ring								
	U-0500-SV	1/2" Sch. 80 SLIP Viton Union	2"	Gray	48	5.8	42UN		
	U-0750-SV	3/4" Sch. 80 SLIP Viton Union	2-1/2"	Gray	24	5.8	42UN		
	U-1000-SV	1" Sch. 80 SLIP Viton Union	2-3/4"	Gray	18	5.5	42UN		
	U-1250-SV	1-1/4" Sch. 80 SLIP Viton Union	3-1/4"	Gray	12	5.8	42UN		
	U-1500-SV	1-1/2" Sch. 80 SLIP Viton Union	3-3/4"	Gray	12	8.2	42UN		
	U-2000-SV	2" Sch. 80 SLIP Viton Union	4"	Gray	6	6.1	42UN		
	U-2500-SV	2-1/2" Gray Union Slip - Viton	5"	Gray	4	6.8	42UN		
	U-3000-SV	3" Gray PVC Union Slip - Viton	6"	Gray	2	5.0	42UN		
	 <p>Sch. 80 Union FPT x FPT Viton O-Ring</p>	Sch. 80 Union FPT x FPT Viton O-Ring							
U-1250-TV		1-1/4" Sch. 80 THRD Viton Union	3-1/4"	Gray	12	5.8	42UN		
U-2000-TV		2" Sch. 80 THRD Viton Union	4"	Gray	6	6.1	42UN		
U-2500-TV		2-1/2" Gray Union THRD - Viton	5"	Gray	4	6.8	42UN		
U-3000-TV	3" Gray Union THRD - Viton	6"	Gray	2	5.0	42UN			

PVC UNIONS SCH. 40

Sch. 40 Union
SLIP x SLIP



Part No.	Description	Body Length	Color	Pkg. Qty.	Case (lbs.)	Product Class	Specifications
Sch. 40 Union SLIP x SLIP							
WU-0750-S	3/4" PVC SCH. 40 Union Slip	2-1/2"	White	24	5.8	42UN	PVC Rated @ 150 PSI @ 72°F NSF/ANSI 61+372 UPC (Slip Only)
WU-1000-S	1" PVC SCH. 40 Union Slip	2-3/4"	White	18	5.5	42UN	
WU-1250-S	1-1/4" PVC SCH. 40 Union Slip	3-1/4"	White	12	5.8	42UN	
WU-1500-S	1-1/2" PVC SCH. 40 Union Slip	3-3/4"	White	12	8.2	42UN	
WU-2000-S	2" PVC SCH. 40 Union Slip	4"	White	6	6.1	42UN	
WU-3000-S	3" PVC SCH. 40 Union Slip	6"	White	2	5.0	42UN	
WU-4000-S	4" PVC SCH. 40 Union Slip	7-1/4"	White	2	6.1	42UN	
Sch. 40 Union FPT x FPT							
WU-0750-T	3/4" PVC SCH. 40 Union FPT	2-1/2"	White	24	5.8	42UN	
WU-1250-T	1-1/4" PVC SCH. 40 Union FPT	3-1/4"	White	12	5.8	42UN	
WU-1500-T	1-1/2" PVC SCH. 40 Union FPT	3-3/4"	White	12	8.2	42UN	
WU-2000-T	2" PVC SCH. 40 Union FPT	4"	White	6	6.1	42UN	

Sch. 40 Union
FPT x FPT



FIRE HYDRANT CAP & SEWER CLEANOUT

Cap



Cleanout



Part No.	IPS Size	Body Length	Color	Pkg. Qty.	Case (lbs.)	Product Class
Cap						
23-25T	2-1/2" FPT x 3/4" FPT	4-3/4"	Gray	15	7.0	41BV
Cleanout						
22-040	4" SEWER CLEANOUT	9-1/4"	Black	6	9.1	41BV

SADDLES

Flo-Tap™ Hot/Wet Taps for PVC Pipe (Rated @ 200 PSI Static Pressure @ 72°F)

For PVC Pipes
3/4" and 1"
Service Lines



For PVC Pipes
1-1/2" and 2"
Service Lines



Part No.	Pipe Size	Branch Size & Connection	Color	Pkg. Qty.	Case (lbs.)	Product Class	Specifications
For PVC Pipes 3/4" and 1" Service Lines							
3115	1-1/2"	3/4" S x 1" SPG	Gray	5	5.5	41FS	For PVC Pipe Pressure Rated @ 200 PSI @ 72°F NSF/ANSI 61+372 PVC Type II
3120	2"	3/4" S x 1" SPG	Gray	5	6.0	41FS	
3125	2-1/2"	3/4" S x 1" SPG	Gray	5	6.0	41FS	
3130	3"	3/4" S x 1" SPG	Gray	5	11.0	41FS	
3140	4"	3/4" S x 1" SPG	Gray	5	11.0	41FS	
3160	6"	3/4" S x 1" SPG	Gray	5	13.0	41FS	
For PVC Pipes 1-1/2" and 2" Service Lines							
3220	2"	1-1/2" S x 2" SPG	Gray	5	9.5	41FS	
3225	2-1/2"	1-1/2" S x 2" SPG	Gray	5	9.5	41FS	
3230	3"	1-1/2" S x 2" SPG	Gray	5	15.0	41FS	
3240	4"	1-1/2" S x 2" SPG	Gray	5	14.0	41FS	
3260	6"	1-1/2" S x 2" SPG	Gray	5	20.0	41FS	
3280	8"	1-1/2" S x 2" SPG	Gray	5	25.0	41FS	

RIGID CLAMP-IT™ SADDLES

For Poly Pipe IPS
Pipe Sizes –
PVC-IPS Fixed
Outlet



For PVC IPS
Pipe Sizes –
PVC-IPS Fixed
Outlet



Part No.	IPS Pipe Size	IPS Tap Size & Connection	Color	Pkg. Qty.	Case (lbs.)	Product Class	Specifications
For Poly Pipe IPS Pipe Sizes – PVC-IPS Fixed Outlet							
321507P	1-1/2"	3/4" FPT	Gray	25	9.0	41FS	For polyethylene tubing main line Pressure Rated @ 125 PSI @ 72°F NSF/ANSI 61+372 PVC Type II
321510P	1-1/2"	1" FPT	Gray	25	9.0	41FS	
331510P	1-1/2"	1" S	Gray	25	9.0	41FS	
322010P	2"	1" FPT	Gray	25	9.0	41FS	
332007P	2"	3/4" S	Gray	25	9.0	41FS	
332010P	2"	1" S	Gray	25	9.0	41FS	
344007P	4"	3/4" FPT	Gray	15	8.0	41FS	
For PVC IPS Pipe Sizes – PVC-IPS Fixed Outlet							
421507	1-1/2"	3/4" FPT	Gray	5	4.0	41FS	For PVC pipe main line Pressure Rated @ 200 PSI @ 72°F NSF/ANSI 61+372 PVC Type II
421510	1-1/2"	1" FPT	Gray	5	4.5	41FS	
422007	2"	3/4" FPT	Gray	5	4.5	41FS	
422010	2"	1" FPT	Gray	5	4.5	41FS	
422012	2"	1-1/4" FPT	Gray	5	5.0	41FS	
422015	2"	1-1/2" FPT	Gray	5	5.0	41FS	
432007	2"	3/4" S	Gray	5	4.5	41FS	
432010	2"	1" S	Gray	5	4.5	41FS	
432012	2"	1-1/4" S	Gray	5	4.5	41FS	
432015	2"	1-1/2" S	Gray	5	5.0	41FS	
422507	2-1/2"	3/4" FPT	Gray	5	5.0	41FS	
422515	2-1/2"	1-1/2" FPT	Gray	5	5.0	41FS	
422520	2-1/2"	2" FPT	Gray	5	5.0	41FS	
432510	2-1/2"	1" S	Gray	5	5.0	41FS	
432515	2-1/2"	1-1/2" S	Gray	5	5.0	41FS	
432520	2-1/2"	2" S	Gray	5	5.0	41FS	
443007	3"	3/4" FPT	Gray	5	8.0	41FS	
443010	3"	1" FPT	Gray	5	8.0	41FS	
443012	3"	1-1/4" FPT	Gray	5	8.5	41FS	
443015	3"	1-1/2" FPT	Gray	5	8.5	41FS	
443020	3"	2" FPT	Gray	5	8.5	41FS	
453007	3"	3/4" S	Gray	5	8.0	41FS	
453010	3"	1" S	Gray	5	8.0	41FS	
453012	3"	1-1/4" S	Gray	5	8.0	41FS	
453015	3"	1-1/2" S	Gray	5	8.5	41FS	
453020	3"	2" S	Gray	5	8.5	41FS	
444007	4"	3/4" FPT	Gray	5	9.5	41FS	
444010	4"	1" FPT	Gray	5	9.5	41FS	
444012	4"	1-1/4" FPT	Gray	5	10.0	41FS	
444015	4"	1-1/2" FPT	Gray	5	10.0	41FS	
444020	4"	2" FPT	Gray	5	10.0	41FS	
454010	4"	1" S	Gray	5	9.5	41FS	
454015	4"	1-1/2" S	Gray	5	9.5	41FS	
454020	4"	2" S	Gray	5	9.5	41FS	
446007	6"	3/4" FPT	Gray	5	12.0	41FS	
446010	6"	1" FPT	Gray	5	12.0	41FS	
446015	6"	1-1/2" FPT	Gray	5	12.5	41FS	
446020	6"	2" FPT	Gray	5	12.5	41FS	
456010	6"	1" S	Gray	5	11.5	41FS	
456015	6"	1-1/2" S	Gray	5	12.0	41FS	
456020	6"	2" S	Gray	5	12.0	41FS	
448010	8"	1" FPT	Gray	5	17.0	41FS	
448015	8"	1-1/2" FPT	Gray	5	17.0	41FS	
448020	8"	2" FPT	Gray	5	17.0	41FS	
458015	8"	1-1/2" S	Gray	5	17.0	41FS	
458020	8"	2" S	Gray	5	17.0	41FS	

SWING JOINTS



PVC Sch. 80
Swing Assembly
GRAY



PVC Sch. 40
Swing Assembly
WHITE

Part No.	Description	Color	Pkg. Qty.	Product Class	Specifications
PVC Sch. 80 Swing Assembly					
TSA-0500-BB	1/2" (BSP x BSP)	Gray	60	42TS	PVC Rated @ 315 PSI @ 72°F
TSA-0500-TT	1/2" M x M	Gray	60	42TS	
TSA-0750-ST	3/4" S x M	Gray	50	42TS	
TSA-0750-TT	3/4" M X M	Gray	50	42TS	
TSA-1000-BB	1" (BSP x BSP)	Gray	25	42TS	
TSA-1000-ST	1" S x M	Gray	25	42TS	
TSA-1000-TT	1" M x M	Gray	25	42TS	
TSA-1250-TT	1-1/4" M x M	Gray	15	42TS	
TSA-1500-TT	1-1/2" M x M	Gray	15	42TS	
PVC Sch. 40 Swing Assembly					
WSA-0500-TT	1/2" (T x T)	White	60	42TS	PVC Rated @ 315 PSI @ 72°F

LANDSCAPE SPRINKLER PRODUCTS

	Part No.	Description	Ctn. Qty.	Product Class	Specifications
Cutoff Risers	Cut-Off Risers				
	FCO-0500	1/2" x 6" Flex Cut-Off	50	42LS	Rated @ 70 PSI @ 72°F
Flex Risers	Flex Risers				
	FR-0500-4	1/2" x 4" MIPT x MIPT Flex Riser	100	42LS	Rated @ 70 PSI @ 72°F
	FR-0500-4F	1/2" x 4" MPT x FPT Flex Riser	100	42LS	
	FR-0500-6	1/2" x 6" MIPT x MIPT Flex Riser	100	42LS	
	FR-0500-6F	1/2" x 6" MIPT x FIPT Flex Riser	100	42LS	
	FR-0750-6	3/4" x 6" MIPT x MIPT Flex Riser	50	42LS	
FR-1000-7	1" x 7" MIPT x MIPT Flex Riser	25	42LS		
Cutoff Riser Extension	Cutoff Riser Extension				
	CRE-0500-3	1/2" x 3" FIPT x MIPT Cutoff Riser Extension	200	42LS	Rated @ 70 PSI @ 72°F
CRE-0750-4	3/4" x 4" FIPT x MIPT Cutoff Riser Extension	200	42LS		
Swing Pipe Fittings	Swing Pipe Fittings				
	FPA-0500	Swing Pipe Adapter .490BARB x 1/2"	50	42LS	
	FPA-0750	3/4" Swing Pipe Adapter	250	42LS	
	FPC-0490	.49" Swing Pipe Connector	250	42LS	
	FPE-0500	1/2" Swing Pipe Elbow	400	42LS	
	FPE-0500F	1/2" Swing Pipe Elbow FPT x Spiral Barb	400	42LS	
	FPE-0750	3/4" Swing Pipe Elbow	250	42LS	
	FPT-0500	1/2" Swing Pipe Tee	500	42LS	
Shrub Adapter	Shrub Adapter				
	SAM-0500	1/2" Male Sprinkler Adapter	50	42LS	Rated @ 70 PSI @ 72°F

BACKWATER VALVES



See list of products on pages 176-177.

TECHNICAL DATA & INSTALLATION

Technical Data

NDS requires that the local and state plumbing codes be reviewed and understood prior to installing any of NDS Flow Management's products. These codes will provide proper installation procedures.

1. PVC Material Specification PVC Type I, Grade I, Cell Class 12454-B meeting requirements of ASTM D-1784-03 is used in the manufacturing of all fittings recommended for use of potable cold water (see chart C for temperature vs. pressure on page 163). Not recommended for use on systems exceeding 100 psi at 120 degrees F.

2. PVC Material Specification PVC Type II, Cell Class NSF14333 of ASTM D-1784 is used in manufacturing of fittings that require more chemical, heat, and impact resistance than PVC I.

3. CPVC Material Specification CPVC Type IV, Grade I, Cell Class 23447-B meeting requirements of ASTM D-1784-03 is used in the manufacturing of all fittings recommended for use on potable Hot Water Systems in accordance with ASTM D-2846-73. Not recommended for use on systems that will exceed 100 psi at 180 degrees F.

4. Buna-N Seals are in accordance with ASTM D-2000. It is generally resistant to many hydrocarbons, fats, oils, greases, hydraulic fluids and chemicals. It is generally attacked by Ozone, Ketones, Esters, Aldehydes, chlorinated and nitro hydrocarbons. Reference chemical resistance under NBR (Nitrile) Elastomers for specific listings.

5. EPDM O-Rings This o-ring material is made of high-quality EPDM (Ethylene Propylene Copolymer) which is in accordance with ASTM D-2000. EPDM has exceptionally good weather aging and ozone resistance, excellent water and chemical resistance, and excellent aging resistance for most applications. EPDM is a polymer where oil and solvent resistance is poor. However, it is fairly good in ketones and alcohols. Reference chemical resistance under EPDM, EPT, or EPR Elastomers for specific listings.

6. Viton O-Rings This o-ring material exhibits a broad range of chemical resistance: petroleum oils, silicone, grease, etc. We recommend you refer to a chemical resistance chart for specific applications. Maximum recommended service temperature is 400° F. Viton is a registered trademark of DuPont.

7. Double Seal of standard compression fitting. A compressive action is created as the cap is tightened squeezing the Buna-N seals into the tapered recessed areas of the cap and body. This process creates a highly concentrated pressure at the two "double seal" points, thus providing positive protection against leakage. (See Figure A on page 164)

8. Acme Thread General purpose 10 pitch and 5 pitch Acme thread on Compression Cap section eliminates the possibility of cross-threading. This smooth running design prevents binding or galling as is often experienced in standard tapered threads.

9. Springs Series 300 Stainless Steel.

TECHNICAL DATA & INSTALLATION

Information

UPC #6-70686-

TEMPERATURE VARIATION AND WORKING PRESSURE CHART

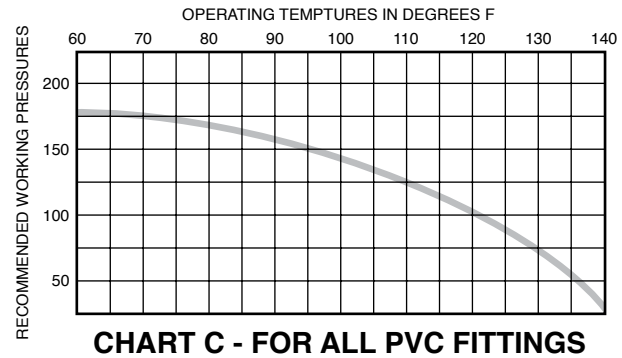

Important

Non-shock valves manufactured from PVC Type I material

WATER HAMMER – NDS requires that all PVC plastic piping systems be designed and constructed to **AVOID EXCESSIVE WATER HAMMER**. Water hammer can cause damage, and failure to pipe, valves, and fittings within the piping system. Not recommended in any shock applications.

NDS DOES NOT RECOMMEND the use of thermoplastic piping products for systems to transport or store compressed air or gases, or the testing of thermoplastic piping systems with compressed air or gases in above and below ground locations. The use of our product in exposed, compressed air or gas systems automatically voids our warranty for such products and its use against our recommendations is entirely the responsibility and liability of the installer. NDS will not accept responsibility for damage or impairment of its products, or other consequential or incidental damages caused by misapplication, incorrect assembly, and/or exposure to harmful substances or conditions. See warranty on inside back cover.

Check valves may be suitable for usage on grinder pump installations, provided the maximum recommended flow velocities through Flow Management plastic valves are not exceeded, the grinder pump system is inspected for proper usage, and on a preventative maintenance schedule. Note that excessive chemical contact and backpressure will cause the check valve gasket to deteriorate at a premature rate. Also, placing the check valve horizontal or at a 45° angle, instead of a vertical position, is recommended. Please follow local code guidelines.

Clamp-It™ / Flo-Tap™ Saddles

CLAMP-IT SADDLE DRILL SIZES	
OUTLET SIZE OVER 2-1/2" PIPE	DRILL SIZE
3/4" IPS S & FPT	3/4"
1" IPS S & FPT	1"
1-1/4" IPS S & FPT	1-1/4"
1-1/2" IPS S & FPT	1-3/8"
2" IPS S & FPT	2"

For 2-1/2" IPS Saddle with a 2" outlet – Drill Size must be 1-1/2" due to pipe restriction

FLO-TAP™ HOT/WET TAP SADDLES	
FOR 3/4" AND 1"	FOR 1-1/2" AND 2"
To drive cutter use a standard 3/8" ratchet with a 6" extension. TAP Cuts .750" hole.	To drive cutter use a standard 1/2" ratchet with a 6" extension. TAP Cuts 1.250" hole.
Captures Coupon – No pipe chips in water system. CAUTION: Do not tap any PVC pipes with wall thickness exceeding .540" (8" C – 900 SDR 18, CLASS 150). Refer to temperature variation and working pressure chart above for maximum pressure vs. maximum temperature.	
NOT FOR USE WITH COMPRESSED AIR OR NATURAL GAS LINES.	

TECHNICAL DATA & INSTALLATION

Installation Instructions

NOTE: NDS does not recommend using an FPT (female) PVC fitting with an MPT (male) metal fitting; ASTM F1498. Unless the female PVC fitting is used with a metal reinforcement ring, it may expand beyond its strength around a metal fitting, which can result in cracks and leaks.

1. Compression Fittings

Compression cap should be drawn up hand-tight to insure proper alignment and seating of gasket, then tighten 3/4 to 1 turn with a Flo Spanner Wrench or strap wrench. Average torque should be approximately 25 foot-pounds on 1/2" through 2" IPS, and 35 foot-pounds on 2-1/2" and larger IPS. Compression fittings are not for use on compressed air lines or natural gas lines. When installing the Standard Compression Seal fittings the pipe line must be restrained from lateral movement by thorough soil compaction on straight runs and thrust blocking at change of direction or reduction in size. Not for use on pipe lines suspended on hangers.

2. Pipe Threads

Use teflon tape on all IPS thread connections. IPS thread connection should be made hand-tight plus 1/2 to 3/4 turn with a wrench.

3. Flo-Lock Adapters

For use on polyethylene tube (PE) with wall thickness of SDR-26, Class 160 or greater, PVC pipe, or copper tubing. Not recommended for use on galvanized pipe unless surface is sanded smooth. (See Figure B)

4. Solvent Welding

NDS requires that all parts that are to be solvent cemented are clean of any and all foreign materials. Solvent cement manufacturers include installation instructions on the container. It is important to follow correct cementing instructions to avoid problems. Excessive cement or the incorrect type of cement can cause failures in thermoplastic products.

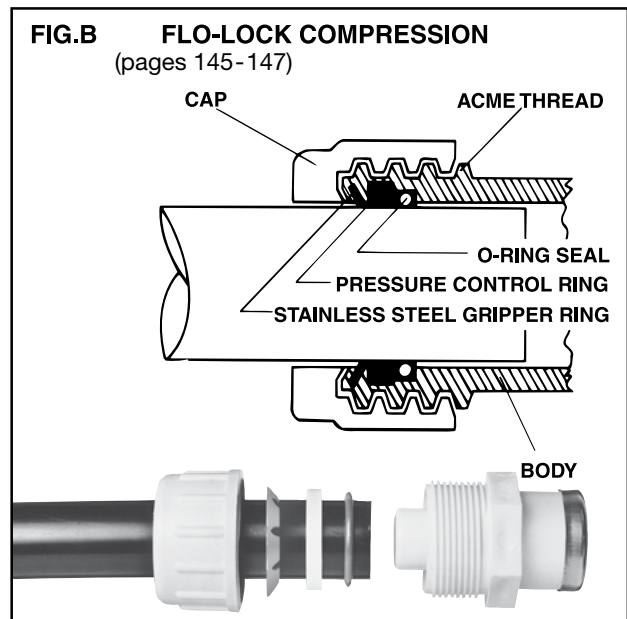
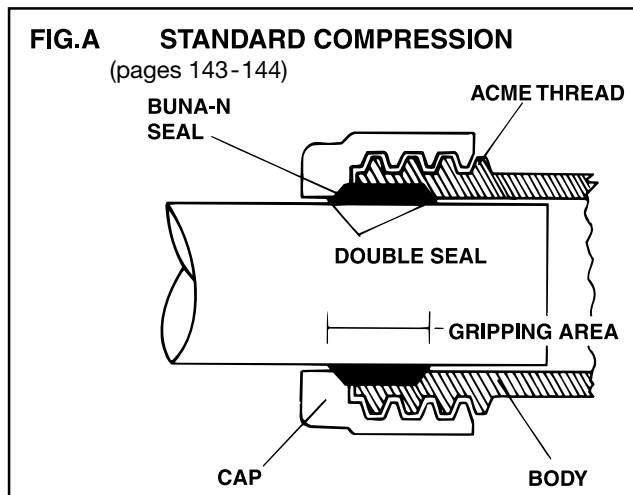

TECHNICAL DATA & INSTALLATION

Pipe Size Legend

Abbreviation	Description
CTS	COPPER TUBE SIZE
IPS	IRON PIPE SIZE (SAME AS SCH. 40 OD)
DR	PE TUBING SIZE
PEP	PE PIPE (SIDR -7)
SDR	PE TUBING SIZE
SIDR	PE TUBING SIZE
TS	PE TUBE SIZE

Connection Type Legend

Abbreviation	Description
SPG	SPIGOT
MPT	MALE PIPE TAPER THREAD
FPT	FEMALE PIPE TAPER THREAD
S	SLIP
U	UNION FITTING WITH SLIP CONNECTION
U x U	TRUE UNION – SLIP CONNECTION WITH UNION ON EACH END
UC	UNION FITTING WITH COMPRESSION CONNECTION
UC x UC	UNION FITTING WITH COMPRESSION CONNECTION ON EACH END
FHT	FEMALE HOSE THREAD
MHT	MALE HOSE THREAD

Pipe & Tube Dimensions

ASTM	SIDR-7	OD	ID	Wall
D2239	3/4"	1.060	0.824	0.118
	1"	1.349	1.049	0.150
	1-1/4"	1.774	1.380	0.197
	1-1/2"	2.070	1.610	0.230
	2"	2.657	2.067	0.295
ASTM	SIDR-9	OD	ID	Wall
D2239	3/4"	1.008	0.824	0.092
	1"	1.283	1.049	0.117
	1-1/4"	1.686	1.380	0.153
	1-1/2"	1.968	1.610	0.179
	2"	2.527	2.067	0.230
ASTM	SDR-9	OD	ID	Wall
D2737	3/4"	0.875	0.681	0.097
	1"	1.125	0.875	0.125
	1-1/4"	1.375	1.069	0.153
	1-1/2"	1.625	1.263	0.181
	2"	2.125	1.653	0.236
ASTM	SDR-11	OD	ID	Wall
D2737	3/4"	0.875	0.715	0.080
	1"	1.125	0.921	0.102
	1-1/4"	1.375	1.125	0.125
ASTM	SCH. 40	OD	ID	Wall
D1785	1/2"	0.840	0.622	0.109
	3/4"	1.050	0.824	0.113
	1"	1.315	1.049	0.133
	SCH. 40 FITTINGS D2466	1-1/4"	1.660	1.380
	1-1/2"	1.900	1.610	0.145
	2"	2.375	2.067	0.154
	2-1/2"	2.875	2.469	0.203
	3"	3.500	3.068	0.216
	4"	4.500	4.026	0.237
	6"	6.625	6.065	0.280
	8"	8.625	7.981	0.322
ASTM	SCH. 80	OD	ID	Wall
D1785	1/2"	0.840	0.546	0.147
	3/4"	1.050	0.742	0.154
	1"	1.315	0.957	0.179
	1-1/4"	1.660	1.278	0.191
SCH. 80 FITTINGS D2467	1-1/2"	1.900	1.500	0.200
	2"	2.375	1.939	0.218
	2-1/2"	2.875	2.323	0.276
ASTM	CTS TYPE L	OD	ID	Wall
B88	1/2"	0.625	0.545	0.040
	5/8"	0.750	0.666	0.042
	3/4"	0.875	0.785	0.045
	1"	1.125	1.025	0.050
	1-1/4"	1.375	1.265	0.055
	1-1/2"	1.625	1.505	0.060
	2"	2.125	1.985	0.070
	2-1/2"	2.625	2.465	0.080
	3"	3.125	2.945	0.090
	ASTM	SDR-13.5	OD	ID
D2666	1"	1.125	0.959	0.083

FLOW MANAGEMENT PRODUCTS INDEX

Part No.	Page	Part No.	Page	Part No.	Page	Part No.	Page	Part No.	Page	Part No.	Page	Part No.	Page
22-040	158	830-71	145	1050C20-15	151	1700C07	150	422507	159	CCT-0500	144	E1320-40	155
23-25T	158	830-121	145	1053C20	151	1700C10	150	422515	159	CCT-1000	144	E1410-05	155
112-05	147	831-07	145	1055C20	151	1700C15	150	422520	159	CCT-1250	144	E1410-07	155
112-07	147	831-10	145	1095-20	150	1700C20	150	432007	159	CCT-2000	144	E1410-10	155
112-10	147	833-07	145	1136-07	150	1700C30	150	432010	159	CPA-0500	144	E1410-12	155
112-12	147	833-10	145	1136-07-05	150	1702-15	150	432012	159	CPA-0750	144	E1410-15	155
112-15	147	833-71	145	1205-05	151	1702-20	150	432015	159	CPA-1000	144	E1410-20	155
112-20	147	935-07	147	1205-07	151	1702C15	150	432510	159	CPA-1250	144	E1410-25	155
118-05	148	935-10	147	1205-07-20	151	1702C20	150	432515	159	CPA-1500	144	E1410-30	155
118-07	148	935-12	147	1205-10	151	1720-07	154	432520	159	CPA-2000	144	E1410-40	155
118-10	148	935-15	147	1205-12	151	1720-10	154	443007	159	CPC-0500	143	E1420-05	155
118-12	148	935-20	147	1205-15	151	1720-15	154	443010	159	CPC-0750	143	E1420-07	155
118-15	148	935-125	147	1205-20	151	1720-20	154	443012	159	CPC-1000	143	E1420-10	155
118-20	148	1001-05	149	1205V07	151	1720-30	154	443015	159	CPC-1250	143	E1420-12	155
118-25	148	1001-07	149	1225-07	151	1720C07	154	443020	159	CPC-1500	143	E1420-15	155
118-30	148	1001-10	149	1225-10	151	1720C10	154	444007	159	CPC-2000	143	E1420-20	155
118-40	148	1001-10FV	148	1225-15	151	1720C15	154	444010	159	CPC-2500	143	E1420-25	155
118-60QF	148	1001-12	149	1228V15	151	1720C20	154	444012	159	CPC-3000	143	E1420-30	155
135-05	147	1001-12FV	148	1235-05	152	1720C30	154	444015	159	CPC-4000	143	E1420-40	155
135-07	147	1001-15	149	1235-05-30	152	1790-15	150	444020	159	CPC-6000	143	E1610-05	156
135-10	147	1001-15FV	148	1235-07	152	1790-20	150	446007	159	CPT-0500-S	143	E1610-07	156
135-12	147	1001-20	149	1235-10	152	1790C15	150	446010	159	CPT-0500-T	143	E1610-10	156
135-15	147	1001-20FV	148	1400-15	154	1790C20	150	446015	159	CPT-0750-S	143	E1610-12	156
135-20	147	1001-25	149	1500-12	153	1795C20	150	446020	159	CPT-0750-T	143	E1610-15	156
136-05	147	1001-30	149	1500-15	153	1800-07	148	448010	159	CPT-1000-S	143	E1610-20	156
136-07	147	1002-05	149	1500-20	153	1800-10	148	448015	159	CPT-1000-T	143	E1610-60	156
136-10	147	1002-07	149	1500-30	153	1800-12	148	448020	159	CPT-1250-S	143	E1620-05	156
235-05	147	1002-10	149	1500C15	153	1800-15	148	453007	159	CPT-1250-T	143	E1620-07	156
235-07	147	1002-12	149	1500C20	153	1800-20	148	453010	159	CPT-1500-S	143	E1620-10	156
235-10	147	1002-15	149	1520-05	153	1901-15	150	453012	159	CPT-1500-T	143	E1620-12	156
235-12	147	1002-20	149	1520-05F	153	1903-15	150	453015	159	CPT-2000-S	143	E1620-15	156
235-15	147	1002-25	149	1520-07	153	2200-15	154	453020	159	CPT-2000-T	143	E1620-20	156
235-20	147	1002-30	149	1520-07F	153	2200-15TU	154	454010	159	CRE-0500-3	161	FCO-0500	161
710-07	146	1010-05-0	152	1520-10	153	2200-15UC	154	454015	159	CRE-0750-4	161	FPA-0500	161
710-10	146	1010-07-0	152	1520-10F	153	2200-20	154	454020	159	CRT-0750-T	143	FPA-0750	161
710-12	146	1011-05	149	1520-12	153	2200-20TU	154	456010	159	CV-0500-FF	152	FPC-0490	161
710-15	146	1011-05-025	149	1520-12F	153	2200-20UC	154	456015	159	CV-0500-FM	152	FPE-0500	161
710-17	146	1011-07	149	1520-15	153	2200C20TU	154	456020	159	CV-0500-MF	152	FPE-0500F	161
710-17-9	146	1011-07-025	149	1520-15F	153	3115	158	458015	159	CV-0575-FM	152	FPE-0750	161
710-20	146	1011-10	149	1520-20	153	3120	158	458020	159	CV-0750-FF	152	FPT-0500	161
730-07	146	1011-12	149	1520-20F	153	3125	158	BTU-0500-HL	156	CV-0750-FM	152	FR-0500-4	161
730-10	146	1011-15	149	1520-30	153	3130	158	BTU-0750-E	156	CV-0750-MF	152	FR-0500-4F	161
730-12	146	1011-20	149	1520-40	153	3140	158	BTU-0750-HL	156	CV-1000-FF	152	FR-0500-6	161
730-15	146	1011-25	149	1520C05	153	3160	158	BTU-1000-E	156	CV-1000-FM	152	FR-0500-6F	161
730-20	146	1011-30	149	1520C05F	153	3220	158	BTU-1000-HL	156	CV-1000-MF	152	FR-0750-6	161
730-71	146	1011C10	149	1520C07	153	3225	158	BTU-1250-E	156	E1310-05	155	FR-1000-7	161
731-07	146	1011C12	149	1520C07F	153	3230	158	BTU-1250-HL	156	E1310-07	155	KSL-0750-S	154
731-10	146	1011C15	149	1520C10	153	3240	158	BTU-1500-E	156	E1310-10	155	KSL-1000-S	154
731-12	146	1011C20	149	1520C10F	153	3260	158	BTU-1500-HL	156	E1310-12	155	KSL-1250-S	154
731-12-10	146	1012-05	149	1520C12	153	3280	158	BTU-2000-E	156	E1310-15	155	KSL-1500-S	154
731-15	146	1012-07	149	1520C15	153	321507P	159	BTU-2000-HL	156	E1310-20	155	KSL-2000-S	154
731-20	146	1012-10	149	1520C15F	153	321510P	159	BTU-2500-SE	156	E1310-25	155	S1050C20	151
731-71	146	1012-12	149	1520C15FV	153	322010P	159	BTU-2500-TE	156	E1310-30	155	S1050C20-05	151
733-07	146	1012-15	149	1520C15V	153	331510P	159	BTU-3000-SE	156	E1310-40	155	S1052C20	151
733-10	146	1012-20	149	1520C20	153	332007P	159	C1310-05	156	E1310-60	155	SAM-0500	161
733-12	146	1012-25	149	1520C20F	153	332010P	159	C1310-07	156	E1320-05	155	SW-0500-C	144
733-15	146	1012-30	149	1520C30	153	344007P	159	C1310-10	156	E1320-07	155	TSA-0500-BB	160
733-20	146	1015-25	149	1520C40	153	421507	159	C1310-12	156	E1320-10	155	TSA-0500-TT	160
733-71	146	1050C10	151	1520V20	153	421510	159	C1310-15	156	E1320-12	155	TSA-0750-ST	160
810-07	145	1050C20	151	1700-07	150	422007	159	C1310-20	156	E1320-15	155	TSA-0750-TT	160
810-10	145	1050C20-05	151	1700-10	150	422010	159	CCC-0500	144	E1320-20	155	TSA-1000-BB	160
830-07	145	1050C20-10	151	1700-15	150	422012	159	CCC-0750	144	E1320-25	155	TSA-1000-ST	160
830-10	145	1050C20-12	151	1700-20	150	422015	159	CCC-1000	144	E1320-30	155	TSA-1000-TT	160

FLOW MANAGEMENT PRODUCTS INDEX

Part No.	Page	Part No.	Page	Part No.	Page	Part No.	Page	Part No.	Page	Part No.	Page	Part No.	Page
TSA-1250-TT	160	U-0750-SV	157	U-1250-SM	157	U-2000-S	157	U-2500-TV	157	UCV-1000-FF	152	WU-2000-S	158
TSA-1500-TT	160	U-0750-T	157	U-1250-SV	157	U-2000-SM	157	U-3000-S	157	WSA-0500-TT	160	WU-2000-T	158
U-0500-S	157	U-1000-S	157	U-1250-T	157	U-2000-ST	157	U-3000-SV	157	WU-0750-S	158	WU-3000-S	158
U-0500-SM	157	U-1000-SM	157	U-1250-TV	157	U-2000-SV	157	U-3000-T	157	WU-0750-T	158	WU-4000-S	158
U-0500-ST	157	U-1000-ST	157	U-1500-S	157	U-2000-T	157	U-3000-TV	157	WU-1000-S	158		
U-0500-SV	157	U-1000-SV	157	U-1500-SM	157	U-2000-TV	157	U-4000-S	157	WU-1250-S	158		
U-0500-T	157	U-1000-T	157	U-1500-ST	157	U-2500-S	157	U-4000-T	157	WU-1250-T	158		
U-0750-S	157	U-1000-TM	157	U-1500-SV	157	U-2500-SV	157	UCV-0500-MF	152	WU-1500-S	158		
U-0750-SM	157	U-1250-S	157	U-1500-T	157	U-2500-T	157	UCV-0750-MF	152	WU-1500-T	158		

NOTES



FITTINGS & CLAMPS



FITTINGS & CLAMPS

Our comprehensive line of sewer and drain fittings includes valves, couplings, and connectors in PVC and styrene. NDS continues its tradition of innovation with the new patent pending Swivel-Fit™ variable angle fitting that combines two fixed fittings into one adjustable fitting solution.

SOLVENT-WELD SEWER & DRAIN FITTINGS

Standards

PVC ASTM D-3034, D-2729

Abbreviations

Hub = Hub Socket (receives pipe & Fitting SPT)

Spt= Spigot (pipe diameter, connect to fitting Hub)

MPT = Male Pipe Thread

FPT = Female Pipe Thread

DWV = Drain, Waste and Vent (Schedule 40 dimensions)

S&D = Sewer and Drain

PVC = Polyvinyl Chloride

HIPS = High-Impact Polystyrene



One Adjustable Fitting for Any Job

The patent-pending Swivel Fit® Variable Angle Fitting can be set to any angle from 0° to 90°. It is a convenient solution to tackle any job and is easy and less expensive than connecting multiple fixed angle fittings.

FITTINGS & CLAMPS

Variable Angle Fittings

Patent Pending



Part No.	Description	Color	Pkg. Qty.	Wt. Ea. (lbs.)	Product Class
4PVAF	PVC S&D Swivel-Fit™ 0-90° Variable-Angled Fitting, 4 in. Hub X Hub	White	12	1.00	30PV

SOLVENT-WELD SEWER & DRAIN FITTINGS

Tee

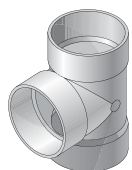

Part No.	Description	Color	Pkg. Qty.	Wt. Ea. (lbs.)	Product Class
3P01	PVC S&D Tee, 3 in. Hub X Hub X Hub	White	35	0.57	30PV
4P01	PVC S&D Tee, 4 in. Hub X Hub X Hub	White	20	0.95	30PV
6P01	PVC S&D Tee, 6 in. Hub X Hub X Hub	White	9	3.66	30PV
64P01	PVC S&D Tee, 6 in. Hub X Hub X 4 in. Hub	White	8	2.38	30PV
8P01	PVC S&D Tee, 8 in. Hub X Hub X Hub	White	2	3.00	30PV
84P01	PVC S&D Tee, 8 in. Hub X Hub X 4 in. Hub	White	7	4.72	30PV
86P01	PVC S&D Tee, 8 in. Hub X Hub X 6 in. Hub	White	3	5.00	30PV

Double Cleanout

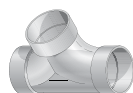

Part No.	Description	Color	Pkg. Qty.	Wt. Ea. (lbs.)	Product Class
417P	PVC S&D Double Cleanout, 4 in. Hub X Hub X Hub	White	24	1.41	30PV

90 Degree Elbow

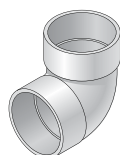

Part No.	Description	Color	Pkg. Qty.	Wt. Ea. (lbs.)	Product Class
3P02	PVC S&D 90° Elbow, 3 in. Hub X Hub	White	40	0.40	30PV
4P02	PVC S&D 90° Elbow, 4 in. Hub X Hub	White	25	0.68	30PV
6P02	PVC S&D 90° Elbow, 6 in. Hub X Hub	White	6	3.00	30PV
8P02	PVC S&D 90° Elbow, 8 in. Hub X Hub	White	4	6.50	30PV

90 Degree Long-Turn Elbow

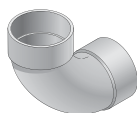

Part No.	Description	Color	Pkg. Qty.	Wt. Ea. (lbs.)	Product Class
31P0	PVC S&D 90° Long-Turn Elbow, 3 in. Hub X Hub	White	30	0.46	30PV
41P0	PVC S&D 90° Long-Turn Elbow, 4 in. Hub X Hub	White	20	0.85	30PV
61P0	PVC S&D 90° Long-Turn Elbow, 6 in. Hub X Hub	White	8	3.10	30PV

90 Degree Long-Turn Street Elbow



Part No.	Description	Color	Pkg. Qty.	Wt. Ea. (lbs.)	Product Class
31POST	PVC S&D 90° Long-Turn Street Elbow, 3 in. Hub X Spt	White	20	0.90	30PV
41POST	PVC S&D 90° Long-Turn Street Elbow, 4 in. Hub X Spt	White	20	1.25	30PV

45 Degree Elbow

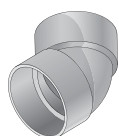

Part No.	Description	Color	Pkg. Qty.	Wt. Ea. (lbs.)	Product Class
3P03	PVC S&D 45° Elbow, 3 in. Hub X Hub	White	40	0.32	30PV
4P03	PVC S&D 45° Elbow, 4 in. Hub X Hub	White	30	0.53	30PV
6P03	PVC S&D 45° Elbow, 6 in. Hub X Hub	White	8	2.12	30PV
8P03	PVC S&D 45° Elbow, 8 in. Hub X Hub	White	6	4.33	30PV

SOLVENT-WELD SEWER & DRAIN FITTINGS

45 Degree Street Elbow

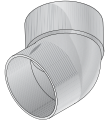

Part No.	Description	Color	Pkg. Qty.	Wt. Ea. (lbs.)	Product Class
3P03ST	PVC S&D 45° Street Elbow, 3 in. Hub X Spt	White	30	0.33	30PV
4P03ST	PVC S&D 45° Street Elbow, 4 in. Hub X Spt	White	30	0.86	30PV
6P03ST	PVC S&D 45° Street Elbow, 6 in. Hub X Spt	White	10	1.80	30PV

22-1/2 Degree Elbow

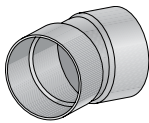

Part No.	Description	Color	Pkg. Qty.	Wt. Ea. (lbs.)	Product Class
3P04	PVC S&D 22.5° Elbow, 3 in. Hub X Hub	White	25	0.32	30PV
4P04	PVC S&D 22.5° Elbow, 4 in. Hub X Hub	White	20	0.45	30PV
6P04	PVC S&D 22.5° Elbow, 6 in. Hub X Hub	White	20	1.60	30PV

Coupling



Part No.	Description	Color	Pkg. Qty.	Wt. Ea. (lbs.)	Product Class
3P05	PVC S&D Coupling, 3 in. Hub X Hub	White	120	0.22	30PV
4P05	PVC S&D Coupling, 4 in. Hub X Hub	White	45	0.37	30PV
6P05	PVC S&D Coupling, 6 in. Hub X Hub	White	10	1.30	30PV
8P05	PVC S&D Coupling, 8 in. Hub X Hub	White	6	3.33	30PV

Slip Repair Coupling

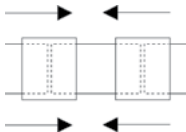

Part No.	Description	Color	Pkg. Qty.	Wt. Ea. (lbs.)	Product Class
3P05R	PVC S&D Slip Repair Coupling, 3 in. Hub X Hub	White	60	0.25	30PV
4P05R	PVC S&D Slip Repair Coupling, 4 in. Hub X Hub	White	45	0.46	30PV

Increaser/Reducer Bushing



Part No.	Description	Color	Pkg. Qty.	Wt. Ea. (lbs.)	Product Class
3P07	PVC S&D Increaser/Reducer Bushing, 3 in. Hub X 4 in. Spt	White	20	0.45	30PV
6P07S	PVC S&D Increaser/Reducer Bushing, 4 in. Hub X 6 in. Spt	White	20	1.10	30PV

Increaser/Reducer Coupling

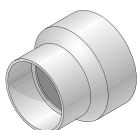

Part No.	Description	Color	Pkg. Qty.	Wt. Ea. (lbs.)	Product Class
4P07	PVC S&D Increaser/Reducer Coupling, 3 in. Hub X 4 in. Hub	White	30	0.36	30PV
6P07	PVC S&D Increaser/Reducer Coupling, 4 in. Hub X 6 in. Hub	White	20	1.10	30PV
8P07	PVC S&D Increaser/Reducer Coupling, 6 in. Hub X 8 in. Hub	White	1	3.00	30PV

SOLVENT-WELD SEWER & DRAIN FITTINGS

45 Degree Wye

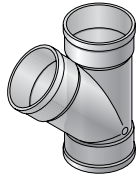

Part No.	Description	Color	Pkg. Qty.	Wt. Ea. (lbs.)	Product Class
3P08	PVC S&D 45° Wye, 3 in. Hub X Hub X Hub	White	25	0.88	30PV
4P08	PVC S&D 45° Wye, 4 in. Hub X Hub X Hub	White	20	1.25	30PV
6P08	PVC S&D 45° Wye, 6 in. Hub X Hub X Hub	White	6	4.66	30PV
64P08	PVC S&D 45° Wye, 6 in. Hub X Hub X 4 in. Hub	White	8	2.88	30PV
8P08	PVC S&D 45° Wye, 8 in. Hub X Hub X Hub	White	2	11.00	30PV
84P08	PVC S&D 45° Wye, 8 in. Hub X Hub X 4 in. Hub	White	6	5.33	30PV
86P08	PVC S&D 45° Wye, 8 in. Hub X Hub X 6 in. Hub	White	3	3.33	30PV

Sanitary (Sweep) Tee



Part No.	Description	Color	Pkg. Qty.	Wt. Ea. (lbs.)	Product Class
3P09	PVC S&D Sanitary Tee, 3 in. Hub X Hub X Hub	White	30	0.66	30PV
4P09	PVC S&D Sanitary Tee, 4 in. Hub X Hub X Hub	White	20	1.60	30PV
6P09	PVC S&D Sanitary Tee, 6 in. Hub X Hub X Hub	White	5	4.20	30PV
8P09	PVC S&D Sanitary Tee, 8 in. Hub X Hub X Hub	White	1	15.00	30PV

Cap

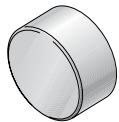

Part No.	Description	Color	Pkg. Qty.	Wt. Ea. (lbs.)	Product Class
3P06	PVC S&D Cap, 3 in. Hub	White	25	0.20	30PV
4P06	PVC S&D Cap, 4 in. Hub	White	25	0.28	30PV
6P06	PVC S&D Cap, 6 in. Hub	White	15	0.93	30PV
8P06	PVC S&D Cap, 8 in. Hub	White	10	2.40	30PV

Female Cleanout Adapter



Part No.	Description	Color	Pkg. Qty.	Wt. Ea. (lbs.)	Product Class
3P11	PVC S&D Female Cleanout Adapter, 3 in. Hub X FPT	White	25	0.36	30PV
4P11	PVC S&D Female Cleanout Adapter, 4 in. Hub X FPT	White	20	0.55	30PV
613P	PVC S&D Female Cleanout Adapter, 6 in. Hub X FPT	White	24	1.08	30PV

Female Fitting Cleanout Adapter



Part No.	Description	Color	Pkg. Qty.	Wt. Ea. (lbs.)	Product Class
413P	PVC S&D Female Fitting Cleanout Adapter, 4 in. Spt X FPT	White	20	0.50	30PV

Cleanout Plug

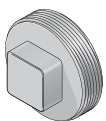

Part No.	Description	Color	Pkg. Qty.	Wt. Ea. (lbs.)	Product Class
31P8	PVC S&D Cleanout Plug, 3 in. MPT	White	50	0.30	30PV
41P8	PVC S&D Cleanout Plug, 4 in. MPT	White	30	0.36	30PV
61P8	PVC S&D Cleanout Plug, 6 in. MPT	White	24	0.62	30PV

SOLVENT-WELD SEWER & DRAIN FITTINGS

Swivel-Fit™ Variable-Angled Fitting

Patent Pending



Part No.	Description	Color	Pkg. Qty.	Wt. Ea. (lbs.)	Product Class
4PVAF	PVC S&D Swivel-Fit™ 0-90° Variable-Angled Fitting, 4 in. Hub X Hub	White	12	1.00	30PV

Cross

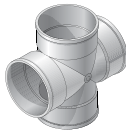

Part No.	Description	Color	Pkg. Qty.	Wt. Ea. (lbs.)	Product Class
4P1X	PVC S&D Cross, 4 in. Hub X Hub X Hub X Hub	White	20	1.40	30PV

Adapter (DWV/SCH40 to S&D)

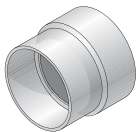

Part No.	Description	Color	Pkg. Qty.	Wt. Ea. (lbs.)	Product Class
3P15	PVC Adapter, 3 in. DWV/SCH40 Hub X S&D Hub	White	60	0.35	30PV
3P16	PVC Adapter, 4 in. DWV/SCH40 Hub X S&D Hub	White	30	0.80	30PV

Adapter Bushing (DWV/SCH40 to S&D)



Part No.	Description	Color	Pkg. Qty.	Wt. Ea. (lbs.)	Product Class
2P41	PVC Adapter Bushing, 3 in. DWV/SCH40 Spt X S&D Hub	White	50	0.12	30PV
2P42	PVC Adapter Bushing, 4 in. DWV/SCH40 Spt X S&D Hub	White	25	0.24	30PV
2P43	PVC Adapter Bushing, 6 in. DWV/SCH40 Spt X S&D Hub	White	20	0.70	30PV

Increaser/Reducer Adapter (DWV/SCH40 to S&D)

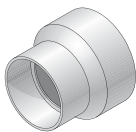

Part No.	Description	Color	Pkg. Qty.	Wt. Ea. (lbs.)	Product Class
533	PVC Increaser/Reducer Adapter, 2 in. DWV/SCH40 Hub X 4 in. S&D Spt	White	20	0.35	30PV
3P12	PVC Increaser/Reducer Adapter, 3 in. DWV/SCH40 Hub X 4 in. S&D Hub	White	50	0.50	30PV
3P17	PVC Increaser/Reducer Adapter, 3 in. DWV/SCH40 Hub X 4 in. S&D Spt	White	30	0.35	30PV

Increaser/Reducer Adapter Bushing (DWV/SCH40 to S&D)

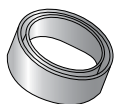

Part No.	Description	Color	Pkg. Qty.	Wt. Ea. (lbs.)	Product Class
532	PVC Increaser/Reducer Adapter Bushing, 2 in. DWV/SCH40 Hub X 3 in. S&D Spt	White	20	0.20	30PV

SOLVENT-WELD SEWER & DRAIN FITTINGS

Downspout Adapter for Sewer & Drain Pipe

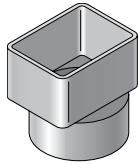

Part No.	Description	Color	Pkg. Qty.	Wt. Ea. (lbs.)	Product Class
9P03	PVC Offset Downspout Adapter, 2X3 in. Downspout X 3 in. S&D Hub	White	40	0.42	30PV
9P04	PVC Offset Downspout Adapter, 2X3 in. Downspout X 4 in. S&D Hub	White	30	0.53	30PV
9P06	PVC Downspout Adapter, 3X4 in. Downspout X 4 in. S&D Hub	White	25	0.50	30PV
9P10	PVC Offset Downspout Adapter, 4X6 in. Downspout X 6 in. S&D Hub	White	15	1.00	30PV
9P13	PVC Offset Downspout Adapter, 3X4 in. Downspout X 4 in. S&D Hub	White	25	0.50	30PV

Downspout Adapter for DWV/Schedule 40 Pipe

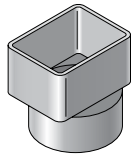

Part No.	Description	Color	Pkg. Qty.	Wt. Ea. (lbs.)	Product Class
9P07	PVC Downspout Adapter, 2X3 in. Downspout X 3 in. DWV/SCH40 Hub	White	40	0.30	30PV
9P08	PVC Downspout Adapter, 2X3 in. Downspout X 4 in. DWV/SCH40 Hub	White	30	1.10	30PV
9P09	PVC Downspout Adapter, 3X4 in. Downspout X 4 in. DWV/SCH40 Hub	White	30	0.44	30PV

POOL ACCESSORIES

Drain Grate



Part No.	Description	Color	Pkg. Qty.	Wt. Ea. (lbs.)	Product Class
9P12	3 in. PVC Round Grate, Fits 3 in. Sewer & Drain Fittings	White	50	0.16	30PV
9P11	4 in. PVC Round Grate, Fits 4 in. Sewer & Drain Fittings	White	25	0.36	30PV

Deck Drain



Part No.	Description	Color	Pkg. Qty.	Wt. Ea. (lbs.)	Product Class
WC100	HIPS S&D Deck Drain, 3 in. Hub	White	50	0.16	30ST
WC100G	HIPS S&D Deck Drain, 3 in. Hub	Gray	50	0.16	30ST
WC100T	HIPS S&D Deck Drain, 3 in. Hub	Tan	50	0.16	30ST

Pool Backflush Fitting

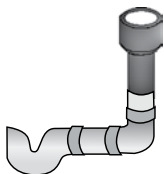

Part No.	Description	Color	Pkg. Qty.	Wt. Ea. (lbs.)	Product Class
650	HDPE Pool Backflush Fitting with Recessed Grate, 4 in. tapered Spt (Includes removable 4" grate NDS #11)	Black	35	0.16	30ST

CORRUGATED FITTINGS

Coupling



Part No.	Description	Color	Pkg. Qty.	Wt. Ea. (lbs.)	Product Class
3C05	HDPE Internal Coupling, 3 in.	Black	60	0.30	11RP
4C07	HDPE Internal Coupling, 4 in.	Black	36	0.30	11RP
6C05	HDPE Internal Coupling, 6 in.	Black	12	0.80	11RP

End Cap



Part No.	Description	Color	Pkg. Qty.	Wt. Ea. (lbs.)	Product Class
3C06	HDPE End Cap, 3 in.	Black	33	0.30	11RP
4C06	HDPE End Cap, 4 in.	Black	32	0.50	11RP
6C06	HDPE End Cap, 6 in.	Black	15	0.50	11RP

Adapter

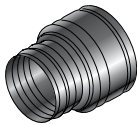

Part No.	Description	Color	Pkg. Qty.	Wt. Ea. (lbs.)	Product Class
351	HDPE Corrugated Adapter, 3 in. Drain Pipes & Fittings Spt X 3 in. Corr. Hub	Black	50	0.10	30PV
451	HDPE Corrugated Adapter, 4 in. Drain Pipes & Fittings Spt X 4 in. Corr. Hub	Black	25	0.20	30PV
651	HDPE Corrugated Adapter, 6 in. Drain Pipes & Fittings Spt X 6 in. Corr. Hub	Black	12	0.25	30PV

Downspout Adapter



Part No.	Description	Color	Pkg. Qty.	Wt. Ea. (lbs.)	Product Class
234CDS	HDPE Downspout Adapter, 2X3 in. Downspout X 4 in. Corr. Hub	Black	24	0.20	30ST
344CDS	HDPE Downspout Adapter, 3X4 in. Downspout X 4 in. Corr. Hub	Black	24	0.20	30ST

DIVERTER AND BACKWATER VALVES

Diverter Valve

Here's the simplest, strongest and most economical diverter valve ever invented for septic tank leach fields. It is made of tough molded plastic that will not shatter, bend, rust or corrode. It is lighter in weight, easier to handle and less expensive to ship.

Functional

The diverter valve stem flow may be controlled to individual or multiple fields (up to three) in any combination. With a three-way valve stem, flow may be diverted to any two outlets. To allow flow through all outlets, the valve stem may be removed from the assembly.

Easy to Install

Connect 4" plastic sewer and drain pipe to inlets and outlets on the four-way distribution box. (Unwanted outlets may be sealed by installing caps.) The diverter shield which houses the diverter stem may be cut to desired length.

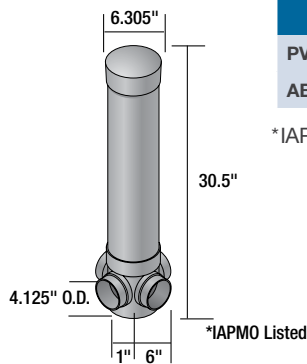

	Part No.	Description	Color	Pkg. Qty.	Wt. Ea. (lbs.)	Product Class
PVC	575P	4" PVC Diverter Valve	White	4	9.50	35PV
ABS*	575	4" ABS Diverter Valve	Black	4	7.50	35AB

*IAPMO Listed.

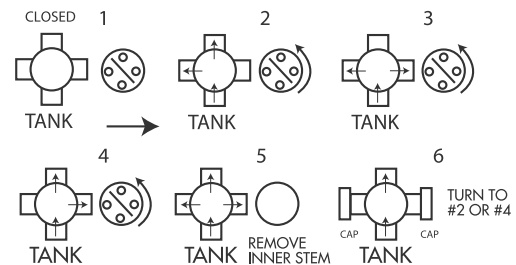

Gravity Backwater Valve

The NDS gravity flow Backwater Valve is designed to protect low areas or basements from the backflow of waste from street sewers. It is available in 2", 3", 4" and 6" sizes, PVC material. It is a cost-effective and a chemically resistant alternative to cast iron valves.

Backwater Valve

The quick action flapper allows unrestricted uni-directional flow. Elastomeric gasket in the flapper ensures a watertight seal. Flapper can be easily removed and replaced if required. Threaded access cap is designed for hand tightening. Access cap neoprene gasket provides a positive seal. Valve hub outlets fit 2", 3", 4" or 6" DWV pipe and may be adapted to 2", 3", 4" or 6" sewer and drain pipe with NDS DWV to Sewer & Drain Adapters. Lightweight, easy to install. Horizontal installation required, with arrows on top of the valve hub pointing in the direction of the flow of water. Access riser with cover offers a simple, economical access to the valve for inspection and maintenance. The riser may be cut to the desired length.

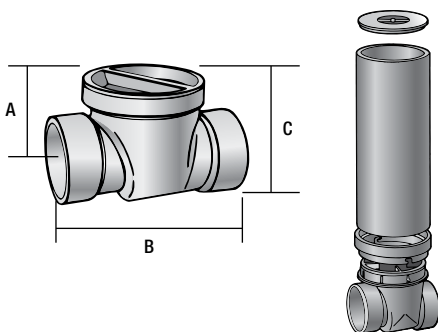

Item Number	A	B	C	Riser Height	Riser Diameter
275P, 275	2.18"	5.03"	3.53"	16"	4"
275PR	2.18"	5.03"	3.53"	16"	4"
375P, 375	3.51"	7.56"	6.10"	16"	6"
375PR	3.51"	7.56"	6.10"	16"	6"
475P, 475	4.47"	11.18"	7.18"	16"	8"
475PR, 475R	4.47"	11.18"	7.18"	16"	8"
675P, 675	5.50"	15.25"	9.90"	16"	10"

Approvals applicable to valve only.



DIVERTER AND BACKWATER VALVES

Backwater Valve



Part No.	Description	Color	Pkg. Qty.	Wt. Ea. (lbs.)	Product Class
275P	2" PVC Backwater Valve	White	8	1.00	35PV
275PR	2" PVC Backwater Valve with Riser and Cover	White	1	5.00	35PV
375P	3" PVC Backwater Valve	White	6	2.33	35PV
375PR	3" PVC Backwater Valve with Riser and Cover	White	1	5.00	35PV
475P	4" PVC Backwater Valve	White	6	4.33	35PV
475PR	4" PVC Backwater Valve with Riser and Cover	White	1	8.00	35PV
675P	6" PVC Backwater Valve	White	1	9.00	35PV
275	2" ABS Backwater Valve	Black	8	1.00	35AB
375	3" ABS Backwater Valve	Black	6	1.83	35AB
475	4" ABS Backwater Valve	Black	6	3.33	35AB
475R	4" ABS Backwater Valve with Riser and Cover	Black	1	7.00	35AB
675	6" ABS Backwater Valve and Cover	Black	1	7.00	35AB

PVC Backwater Valve Components

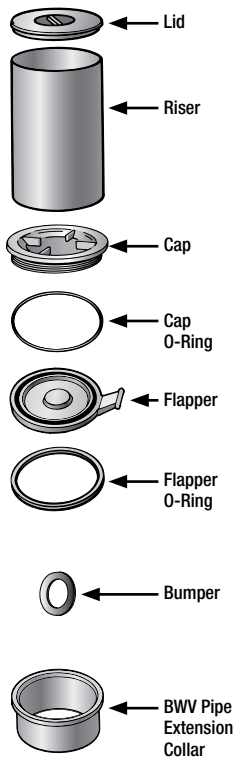

Part No.	Description	Color	Carton Qty.	Product Class
8051-020-040	2" Lid	White	20	35PV
822-040-16	2" Riser	White	4	35PV
1530202	2" Cap	White	10	35PV
880-237	2" Cap O-Ring	Black	10	35PV
1530203	2" Flapper	White	10	35PV
880-136	2" Flapper O-Ring	Black	10	35PV
1530204	2" Backwater Valve Pipe Extension Collar	White	10	35PV
8051-030-060	3" Lid	White	25	35PV
822-060-16	3" Riser	White	2	35PV
1530302	3" Cap	White	10	35PV
880-253	3" Cap O-Ring	Black	10	35PV
1530303	3" Flapper	White	10	35PV
880-234	3" Flapper O-Ring	Black	10	35PV
1530304	3" Backwater Valve Pipe Extension Collar	White	10	35PV
8051-040-080	4" Lid	White	20	35PV
822-080-16	4" Riser	White	1	35PV
1530402	4" Cap	White	10	35PV
880-364	4" Cap O-Ring	Black	10	35PV
1530403	4" Flapper	White	10	35PV
880-243	4" Flapper O-Ring	Black	10	35PV
1530404	4" Backwater Valve Pipe Extension Collar	White	10	35PV
8051-060-100	6" Lid	White	15	35PV
1530602	6" Cap	White	2	35PV
880-271	6" Cap O-Ring	Black	2	35PV
1530603	6" Flapper	White	5	35PV
880-259	6" Flapper O-Ring	Black	5	35PV
880-202	Bumper (fits all sizes of valves)	Black	1	35PV
1530405	4" BWV Sewer Adapt Flange	White	1	35PV
1530605	6" BWV Sewer Adapt Flange	White	1	35PV

FITTINGS & CLAMPS

Backwater Valve Box

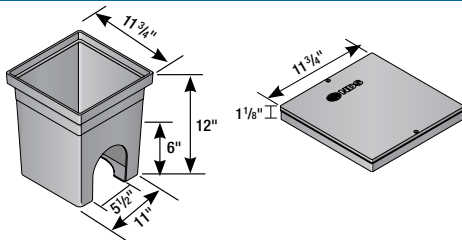

Part No.	Description	Color	Pkg. Qty.	Wt. Ea. (lbs.)	Product Class
1219	12" x 12" Backwater Valve Box	Black	4	5.75	10ND
1220	12" x 12" Valve Box Cover	Black	8	2.00	10ND

NDS FLEXIBLE COUPLINGS AND CONNECTORS

- Choose the high-quality couplings and connectors that easily adapt to any situation
- Innovative, flexible couplings for sewer, drain, waste and vent piping allow any two pipes to be connected quickly and easily
- Dimensional flexibility ensures leakproof seals with virtually any pipe material
- Utility and plumbing applications

Details

- Couplings and connectors fit over the ends of plain-end or spigot pipe to form a positive seal against infiltration and exfiltration in non-pressure environments
- Durable PVC construction allows couplings to flex with normal earth movement
- Completely unaffected by soil conditions and resistant to chemicals, UV rays and normal sewer gases

Materials and Standards

- Flexible couplings are made of elastomeric polyvinyl chloride (PVC) for long-lasting performance and durability
- Bactericides and fungicides are added to PVC for extra protection
- All NDS clamps, including the band and housing, are made from series 300 stainless steel, offering corrosion-resistant, rustproof reliability
- NDS Flexible Couplings have listings from the following code agencies: ICC (International Code Council), CSA (Canadian Standards Association) and IAPMO (International Association of Plumbing and Mechanical Officials)

Installation

- Clamps install easily with a screwdriver, 5/16" nut driver or socket to 60 inch-lbs. pounds torque
- All couplings are marked with size and pipe materials that the coupling will connect, eliminating guesswork on the job

NDS Flexible Coupling Sizing Chart

FITTINGS & CLAMPS

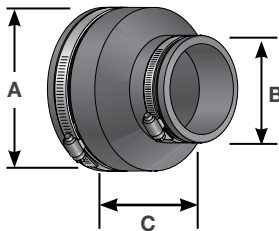

- All dimensions given in inches and mm.
- Couplings available to connect 1-1/4" to 15" pipe.
- 300 Series stainless steel clamps supplied with all couplings.
- All couplings will fit any pipe type within +/- 5% OD on chart.

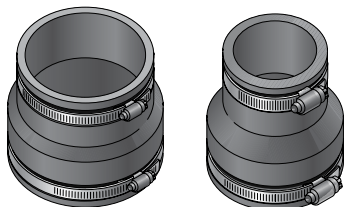

Clay to Clay

Part No.	A		B		C		Pkg. Qty.	Weight	Product Class
	Inches	mm	Inches	mm	Inches	mm			
01-44	5.25	133	5.25	133	4.00	101	18	1.27	45C0

Clay to Cast Iron or Plastic

Part No.	A		B		C		Pkg. Qty.	Weight	Product Class
	Inches	mm	Inches	mm	Inches	mm			
02-43	5.25	133	3.38	85	4.00	101	36	1.25	45C0
02-44	5.25	133	4.38	111	4.00	101	24	1.04	45C0
02-55	USE PART NO. 56-65								
02-64	7.38	187	4.38	111	6.00	152	12	2.50	45C0
02-66	7.38	187	6.38	162	6.00	152	18	2.38	45C0
02-88	9.65	245	8.50	215	6.00	152	6	3.16	45C0
02-1010	11.80	299	10.60	269	6.00	152	3	4.00	45C0
02-1212	14.38	365	12.60	320	6.00	152	5	5.20	45C0
02-1515	17.85	453	15.40	391	6.00	152	5	6.00	45C0

Concrete to Cast Iron or Plastic

Part No.	A		B		C		Pkg. Qty.	Weight	Product Class
	Inches	mm	Inches	mm	Inches	mm			
06-44	5.62	142	4.38	111	4.00	101	18	1.66	45C0
06-64	7.80	198	4.38	111	6.00	152	12	2.41	45C0
06-66	7.80	198	6.38	162	6.00	152	12	2.58	45C0
06-88	10.25	260	8.50	215	6.00	152	6	3.33	45C0

NDS FLEXIBLE COUPLINGS AND CONNECTORS

NDS Flexible Coupling Sizing Chart

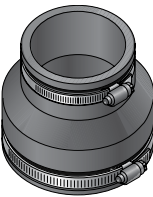
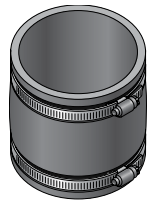
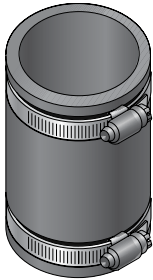

Asbestos Cement, Fibre or Ductile Iron to Cast Iron or Plastic

Part No.	A		B		C		Pkg. Qty.	Weight	Product Class
	Inches	mm	Inches	mm	Inches	mm			
51-44	4.75	120	4.38	111	4.00	101	24	1.08	45CO
51-66	7.00	177	6.38	162	6.00	152	15	2.73	45CO

Cast Iron, Plastic, Copper, Steel or Lead to Cast Iron, Plastic, Copper, Steel or Lead

Part No.	A		B		C		Pkg. Qty.	Weight	Product Class
	Inches	mm	Inches	mm	Inches	mm			
56-125	1.65	40	1.65	40	4.00	101	90	0.36	45CO
56-150/125	1.90	48	1.65	40	4.00	101	75	0.41	45CO
56-150	1.90	48	1.90	48	4.00	101	75	0.41	45CO
56-2150	2.40	60	1.90	48	4.00	101	54	0.51	45CO
56-22	2.40	60	2.40	60	4.00	101	54	0.50	45CO
56-32	3.38	85	2.40	60	4.00	101	45	0.71	45CO
56-33	3.38	85	3.38	85	4.00	101	45	0.75	45CO
56-42	4.38	111	2.40	60	4.00	101	30	0.93	45CO
56-E43	4.38	111	3.38	85	4.00	101	24	1.37	45CO
56-43	4.38	111	3.38	85	4.00	101	25	1.08	45CO
56-44	4.42	112	4.42	112	4.00	101	24	1.66	45CO
56-44W	4.42	112	4.42	112	4.00	101	24	1.17	45CO
56-55	5.62	142	5.62	142	4.00	101	18	1.38	45CO
56-63	6.38	162	3.38	85	6.00	152	12	1.67	45CO
56-E64	6.38	162	4.38	111	6.00	152	10	2.20	45CO
56-64	6.38	162	4.38	111	6.00	152	12	2.16	45CO
56-66	6.38	162	6.38	162	6.00	152	15	2.13	45CO
56-86	8.50	215	6.38	162	6.00	152	8	3.37	45CO
56-88	8.50	215	8.50	215	6.00	152	12	3.50	45CO
56-1010	10.60	269	10.60	269	7.00	178	2	6.00	45CO
56-1212	12.83	326	12.83	326	6.00	152	3	5.00	45CO

NDS FLEXIBLE COUPLING SIZING CHART

Drain and Trap Connectors

NDS Drain & Trap Connectors are ideal for new installation, alterations and repairs. These connectors offer a quick, low-cost alternative to gluing or soldering and eliminate the need for special tools or threading. Simply place the ends over the pipes and tighten the stainless steel clamps.

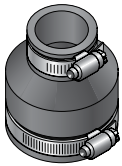

Part No.	Description	Color	Pkg. Qty.	Wt. Ea. (lbs.)	Product Class
57-125	1-1/4" or 1-1/2" Drain Piping x 1-1/4" or 1-1/2" Drain Piping	Black	180	0.17	45CO
57-125/125	1-1/4" DWV or 1-1/2" Copper x 1-1/4" or 1-1/2" Drain Piping	Black	140	0.22	45CO
57-150/125	1-1/2" DWV or 1-1/2" Copper x 1-1/4" or 1-1/2" Drain Piping	Black	120	0.25	45CO

Large Diameter Couplings

Large Diameter Couplings are available through NDS. The large couplings are engineered for use with all the common pipe material: clay, concrete, cast iron, plastic, fiberglass, ductile iron and asbestos/cement. When ordering please remember to provide the exact O.D. size in inches for both pipes. A difference of 6" between the two pipe O.D. sizes cannot be made. Please call for details 1-800-726-1994.

Expansion Joints

NDS Flexible Expansion Joints have a one-piece design which allows for the thermal contraction and expansion of drain, waste and vent. These couplings are maintenance free and rustproof. They are secured by series 300 stainless steel clamps. NDS expansion joints are made of tough elastomeric polyvinyl chloride (PVC). They are strong and resilient. Available in 2" and 3" sizes.

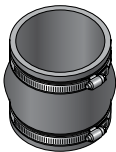
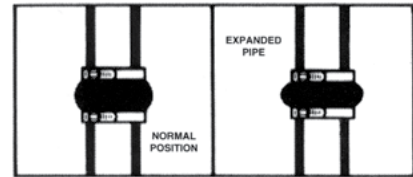

Part No.	Description	Color	Pkg. Qty.	Wt. Ea. (lbs.)	Product Class
XJ3	3" Expansion Joints	Black	24	0.67	45CO

Clamps for Flexible Couplings

CLAMP MIN. & MAX. DIAMETERS & OVERALL LENGTH							
Part No.	Max. Dia.	Min. Dia.	Length	Color	Weight	Pkg. Qty.	Product Class
33H020 CLAMP	1.75"	.75"	6-1/2"	Stainless Steel	0.05	500	45CO
33H032 CLAMP	2.50"	1.00"	8-3/4"	Stainless Steel	0.05	400	45CO
33H040 CLAMP	3.00"	2.06"	10-3/8"	Stainless Steel	0.05	400	45CO
33H056 CLAMP	4.00"	1.00"	13-1/2"	Stainless Steel	0.10	300	45CO
33H088 CLAMP	6.00"	2.00"	19-3/4"	Stainless Steel	0.10	200	45CO
33H116 CLAMP	7.75"	1.75"	25"	Stainless Steel	0.10	100	45CO
33H164 CLAMP	10.75"	1.75"	34-5/8"	Stainless Steel	0.15	100	45CO
33H188 CLAMP	12.25"	6.25"	39-1/2"	Stainless Steel	0.15	100	45CO
33H212 CLAMP	13.75"	11.75"	44"	Stainless Steel	0.20	100	45CO
33H250 CLAMP	12.62"	8.75"	40-1/2"	Stainless Steel	0.25	100	45CO
33S248 CLAMP	16"	3.625"	51-1/2"	Stainless Steel	0.25	100	45FS

NDS CONNECTORS AND O-RINGS

NDS Connectors for sewer pipe joints and drain waste & vent piping allow several points of seal between most types of sockets, hubs, bells and spigots. NDS Connectors are donut-shaped rings made of tough elastomeric polyvinyl chloride (PVC) and are available in a range of sizes up to 6". They install quickly and easily and offer the dimensional flexibility that ensures leakproof seals. They are also resistant to chemicals, fungus growth and normal sewer gases due to the inert nature and physical properties of the material. NDS O-Rings provide a quick and easy connection between most 4" house pipes and 6" sewer pipes. *NOTE: Connectors may not perform as intended due to improper or insufficient description of the pipes being connected or changes in pipe dimensions or design by the various manufacturers.*

SV Cast Iron Connectors



Part No.	Description	Color	Pkg. Qty.	Wt. Ea. (lbs.)	Product Class
44U-405	4" x 4" SV HUB x Sch40 (DWW) or Sch40 Steel or C.I.XH	Black	35	0.48	45C0

Asbestos Cement Connectors – John Manville and Capco



Part No.	Description	Color	Pkg. Qty.	Wt. Ea. (lbs.)	Product Class
44U-405	4" x 4" SW Duplex Adapter x C.I.XH or ABS/PVC DWV	Black	35	0.48	45C0

Cleanout or Test Caps

NDS Cleanout or Test Caps are designed to fit drain, waste and vent pipe materials. The 1-1/2" thru 4" NDS Caps are designed to fit schedule 40 nominal pipe sizes. The 6" thru 10" NDS Caps are designed to fit SDR 35 nominal pipe sizes. Our caps offer a quick and easy way to cap pipe ends and cleanouts. The reinforced convex face allows the cap to withstand greater pressure for testing and minimize ballooning. They are also low cost and reusable.

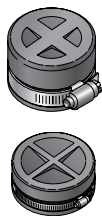

Part No.	Description	Color	Pkg. Qty.	Wt. Ea. (lbs.)	Product Calss	Product Class
150	1-1/2" Cap	Black	100	0.19	45CP	IAMPO Listed.
102	2" Cap	Black	100	0.21	45CP	
103	3" Cap	Black	50	0.90	45CP	
104	4" Cap	Black	50	0.44	45CP	
105	5" Cap	Black	24	0.87	45CP	
106	6" Cap	Black	24	0.95	45CP	
108	8" Cap	Black	16	1.81	45CP	

CONCRETE MANHOLE COVER ADAPTERS

NDS Concrete Manhole Cover Adapters are made of elastomeric polyvinyl chloride (PVC) and are available for 4", 6", 8", 10", and 12" pipe. Our adapters help eliminate leaks around pipe entering manhole walls and are flexible enough to permit some lateral pipe movement without compromising the integrity of the seal. However, NDS does not warrant this product as a positive water seal due to the many varying factors that can influence the product's effectiveness as a positive seal, such as: field conditions, quality of grout, workmanship and high-ground water tables.



Part No.	Description	Color	Pkg. Qty.	Wt. Ea. (lbs.)	Product Class
4MA	4" Manhole Adapter	Black	24	1.00	45C0
6MA	6" Manhole Adapter	Black	24	0.62	45C0
8MA	8" Manhole Adapter	Black	14	1.00	45C0
12MA	12" Manhole Adapter	Black	6	1.50	45C0

NDS FLEXIBLE SADDLES

For superior durability and flexibility, saddle up. A breakthrough in saddle design, the patented NDS Flexible Saddle demonstrates superior flexibility in more than one way. The saddle's elastomeric construction allows a single description to securely fit 6" sewer main pipe diameters and up. The saddle's flexibility eliminates the need for a large inventory of rigid PVC saddles of various descriptions.

NDS Flexible Saddle offers the following product benefits:

- Two configurations, a "Tee" and a "Wye" are available in 4" or 6" inlet descriptions
- Elastomeric construction provides maximum strength and flexibility
- Saddle design will accommodate polyethylene pipe used in slip lining sewer systems
- Inlet range from SCH-40 down to SDR-35 includes standard weight soil pipe
- Stainless steel series 300 clamps ensure tight seal
- Steel-reinforced edges prevent distortion when torque is applied to clamps
- Durable design and low unit price make the Flexible Saddle economical and environmentally wise
- Available saddle blanket, attached to pipe prior to saddle installation, will mend imperfections and cracks on clay pipe taps

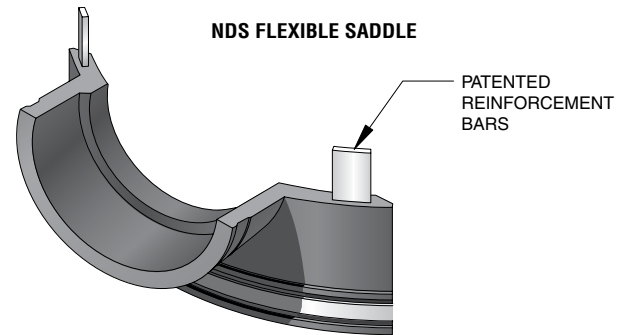

NDS Flexible Saddles

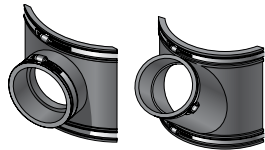

Part No.	Description	Color	Pkg. Qty.	Wt. Ea. (lbs.)	Product Class
4T/C	4" Tees with Clamps	Black	12	3.16	45FS
4T/WOC	4" Tees without Clamps	Black	12	2.66	45FS
4Y/C	4" Wyes with Clamps	Black	6	7.66	45FS
4Y/WOC	4" Wyes without Clamps	Black	6	7.12	45FS
6T/C	6" Tees with Clamps	Black	6	6.50	45FS
6T/WOC	6" Tees without Clamps	Black	6	6.0	45FS
6Y/C	6" Wyes with Clamps	Black	4	9.9	45FS
6Y/WOC	6" Flex Wye without Clamps	Black	4	11.75	45FS

Saddle Clamps

Part No.	Description	Color	Pkg. Qty.	Wt. Ea. (lbs.)	Product Class
33S248 CLAMP	Clamp for Flexible Coupling	Stainless Steel	100	0.25	45FS

ASTM Material Specification

Test	NDS Material	ASTM Test Material
Chemical Resistance 1N sulfuric acid 1N hydrochloric acid	No weight loss No weight loss	D543
Tensile Strength Elongation	1000 psi (7Mpa) min. 200% min. elongation @ break	D412 Die "C"
Duration Hardness	Shore durometer 50 min. to 75 max.	D2240
Compression Set	30% max. of original deflection	D395, Method B Type 2
Water Absorption	5% max.	D471, immersed 7 days @158 Method A
Ozone Resistance	No visible cracking under 7x magnification	D1149, D518 Method A
Oven Aging	75% min. of original tensile strength 65% min. of original elongation	D573 (158°F for 70 hours)
Cold Brittleness	Cold brittleness was determined to be -43°C	D476
Tear Strength	125 lbs./in.	D624 Die "C"

CLAMPS

Stainless Steel Pinch "Crimp" Hose Clamps



Part No.	Description	Pkg. Qty.	Case. Qty.	Product Class
NC-155000-003	133R 1/2" SS Crimp Clamp	100	100	45PC
NC-155000-008	157R 3/8" SS Crimp Clamp	100	100	45PC
NC-155000-009	170R SS Crimp Clamp	100	100	45PC
NC-155000-010	185R 23/32" SS Crimp Clamp	100	3000	45PC
NC-155000-011	198R 5/8" SS Crimp Clamp	100	3000	45PC
NC-155000-012	210R 13/16" SS Crimp Clamp	100	2500	45PC
NC-155000-013	226R SS Crimp Clamp	100	100	45PC
NC-155000-015	256R 3/4" SS Crimp Clamp	100	100	45PC
NC-155000-016	271R 3/4" SS Crimp Clamp	100	2000	45PC
NC-155000-017	286R SS Crimp Clamp	100	100	45PC
NC-155000-019	316R 15/16" SS Crimp Clamp	100	2000	45PC
NC-155000-020	331R 1" SS Crimp Clamp	100	2000	45PC
NC-155000-021	346R 1-3/8" SS Crimp Clamp	100	1500	45PC
NC-155000-022	361R SS Crimp Clamp	100	1500	45PC
NC-155000-025	396R SS Crimp Clamp	80	100	45PC
NC-155000-027	425R 1-1/4" SS Crimp Clamp	80	1500	45PC
NC-155000-028	440R 1-1/4" SS Crimp Clamp	80	100	45PC
NC-155000-031	485R 1-7/8" SS Crimp Clamp	50	1500	45PC
NC-155000-032	500R 1-1/2" SS Crimp Clamp	50	100	45PC
NC-155000-033	515R 1-1/2" SS Crimp Clamp	50	100	45PC
NC-155000-039	605R 2-3/8" SS Crimp Clamp	40	100	45PC
NC-155000-042	650R 2 SS Crimp Clamp	30	100	45PC

Stainless Steel Pinch Clamp Crimp Tool



Part No.	Description	Pkg. Qty.	Carton Qty.	Product Class
NCT-1098	Standard Jaw Crimp Tool	1	10	45PC

CLAMPS

Worm Drive Hose Clamps



Superior Longevity – 100% stainless steel construction

Added Strength – 4 piece design includes underside plate, Conical arched perforated slots

Smoother Worm Drive – Buttressed threads and more threads per screw

Primarily use to tighten around and secure pliable (soft) hose or tube

Plumbing: Connections for dishwashers, garbage disposals, water softeners, air conditioning

Irrigation: Secure poly tubing, stabilize risers to stake

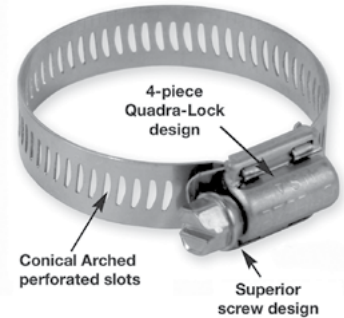

Part No.	Description	Pkg. Qty.	Case. Qty.	Product Class
3604	SAE 6, 5/16" Band Width, Effective Diameter Range: 7/16" Min., 25/32" Max.	10	200	45HC
3606	SAE 8, 5/16" Band Width, Effective Diameter Range: 1/2" Min., 29/32" Max.	10	200	45HC
64006H	SAE 6, 1/2" Band Width, Effective Diameter Range: 7/16" Min., 25/32" Max.	10	200	45HC
64008H	SAE 8, 1/2" Band Width, Effective Diameter Range: 1/2" Min., 29/32" Max.	10	200	45HC
64010H	SAE 10, 1/2" Band Width, Effective Diameter Range: 9/16" Min., 1-1/8" Max.	10	500	45HC
64012H	SAE 12, 1/2" Band Width, Effective Diameter Range: 11/16" Min., 1-1/4" Max.	10	500	45HC
64016H	SAE 16, 1/2" Band Width, Effective Diameter Range: 13/16" Min., 1-1/2" Max.	10	500	45HC
64020H	SAE 20, 1/2" Band Width, Effective Diameter Range: 13/16" Min., 1-3/4" Max.	10	500	45HC
64024H	SAE 24, 1/2" Band Width, Effective Diameter Range: 1-1/16" Min., 2" Max.	10	500	45HC
64028H	SAE 28, 1/2" Band Width, Effective Diameter Range: 1-5/16" Min., 2-1/4" Max.	10	500	45HC
64032H	SAE 32, 1/2" Band Width, Effective Diameter Range: 1-9/16" Min., 2-1/2" Max.	10	500	45HC
64036H	SAE 36, 1/2" Band Width, Effective Diameter Range: 1-13/16" Min., 2-3/4" Max.	10	500	45HC
64040H	SAE 40, 1/2" Band Width, Effective Diameter Range: 2-1/16" Min., 3" Max.	10	200	45HC
64044H	SAE 44, 1/2" Band Width, Effective Diameter Range: 2-5/16" Min., 3-1/4" Max.	10	200	45HC
64048H	SAE 48, 1/2" Band Width, Effective Diameter Range: 2-9/16" Min., 3-1/2" Max.	10	200	45HC
64052H	SAE 52, 1/2" Band Width, Effective Diameter Range: 2-13/16" Min., 3-3/4" Max.	10	200	45HC
64056H	SAE 56, 1/2" Band Width, Effective Diameter Range: 3-1/16" Min., 4" Max.	10	200	45HC
64064H	SAE 62, 1/2" Band Width, Effective Diameter Range: 3-9/16" Min., 4-1/2" Max.	10	200	45HC
64072H	SAE 72, 1/2" Band Width, Effective Diameter Range: 1-7/8" Min., 5" Max.	10	100	45HC
64080H	SAE 80, 1/2" Band Width, Effective Diameter Range: 2-1/2" Min., 5-1/2" Max.	10	100	45HC
64088H	SAE 88, 1/2" Band Width, Effective Diameter Range: 3-1/8" Min., 6" Max.	10	100	45HC
64096H	SAE 96, 1/2" Band Width, Effective Diameter Range: 3-5/8" Min., 6-1/2" Max.	10	100	45HC
64104H	SAE 104, 1/2" Band Width, Effective Diameter Range: 4-1/8" Min., 7" Max.	10	100	45HC

FITTINGS & CLAMPS

CLAMPS

Worm Drive Hose Clamps (cont.)



Part No.	Description	Pkg. Qty.	Case. Qty.	Product Class
200 06 H	SAE 6, 9/16" Band Width, Effective Diameter Range: 7/16" Min., 25/32" Max.	10	200	45HC
200 08 H	SAE 8, 9/16" Band Width, Effective Diameter Range: 1/2" Min., 29/32" Max.	10	200	45HC
200 10 H	SAE 10, 9/16" Band Width, Effective Diameter Range: 9/16" Min., 1-1/6" Max.	10	500	45HC
200 12 H	SAE 12, 9/16" Band Width, Effective Diameter Range: 11/16" Min., 1-1/4" Max.	10	500	45HC
200 16 H	SAE 16, 9/16" Band Width, Effective Diameter Range: 13/16" Min., 1-1/2" Max.	10	500	45HC
200 20 H	SAE 20, 9/16" Band Width, Effective Diameter Range: 13/16" Min., 1-3/4" Max.	10	500	45HC
200 24 H	SAE 24, 9/16" Band Width, Effective Diameter Range: 1-1/16" Min., 2" Max.	10	500	45HC
200 28 H	SAE 28, 9/16" Band Width, Effective Diameter Range: 1-5/16" Min., 2-1/4" Max.	10	500	45HC
200 32 H	SAE 32, 9/16" Band Width, Effective Diameter Range: 1-9/16" Min., 2-1/2" Max.	10	500	45HC
200 36 H	SAE 36, 9/16" Band Width, Effective Diameter Range: 1-13/16" Min., 2-3/4" Max.	10	500	45HC
200 40 H	SAE 40, 9/16" Band Width, Effective Diameter Range: 2-1/16" Min., 3" Max.	10	200	45HC
200 44 H	SAE 44, 9/16" Band Width, Effective Diameter Range: 2-5/16" Min., 3-1/4" Max.	10	200	45HC
200 48 H	SAE 48, 9/16" Band Width, Effective Diameter Range: 2-9/16" Min., 3-1/2" Max.	10	200	45HC
200 52 H	SAE 52, 9/16" Band Width, Effective Diameter Range: 2-13/16" Min., 3-3/4" Max.	10	200	45HC
200 56 H	SAE 56, 9/16" Band Width, Effective Diameter Range: 3-1/16" Min., 4" Max.	10	200	45HC
200 64 H	SAE 62, 9/16" Band Width, Effective Diameter Range: 3-9/16" Min., 4-1/2" Max.	10	200	45HC
200 72 H	SAE 72, 9/16" Band Width, Effective Diameter Range: 1-7/8" Min., 5" Max.	10	100	45HC
200 80 H	SAE 80, 9/16" Band Width, Effective Diameter Range: 2-1/2" Min., 5-1/2" Max.	10	100	45HC
200 88 H	SAE 88, 9/16" Band Width, Effective Diameter Range: 3-1/8" Min., 6" Max.	10	100	45HC
200 96 H	SAE 96, 9/16" Band Width, Effective Diameter Range: 3-5/8" Min., 6-1/2" Max.	10	100	45HC
200 104 H	SAE 104, 9/16" Band Width, Effective Diameter Range: 4-1/8" Min., 7" Max.	10	100	45HC
200 128 H	SAE 128, 9/16" Band Width, Effective Diameter Range: 5-5/8" Min., 8-1/2" Max.	10	100	45HC
200 152 H	SAE 152, 9/16" Band Width, Effective Diameter Range: 7-1/8" Min., 10" Max.	10	100	45HC
200 188 H	SAE 188, 9/16" Band Width, Effective Diameter Range: 9-3/8" Min., 12-1/4" Max.	10	100	45HC
200 212 H	SAE 212, 9/16" Band Width, Effective Diameter Range: 10-7/8" Min., 13-3/4" Max.	10	100	45HC

CLAMPS

Clamp-All® Hi-Torq Hubless Pipe Couplings



Part No.	Size	Description	Carton Qty.	Weight (lbs.)	Product Class
81015	1-1/2"	Hi-Torq 80 Couplings	80	34	45CA
81020	2"	Hi-Torq 80 Couplings	64	31	45CA
81030	3"	Hi-Torq 80 Couplings	36	23	45CA
81040	4"	Hi-Torq 80 Couplings	36	28	45CA
81050	5"	Hi-Torq 80 Couplings	12	17	45CA
81060	6"	Hi-Torq 80 Couplings	12	20	45CA
81080	8"	Hi-Torq 80 Couplings	8	16	45CA
81100	10"	Hi-Torq 80 Couplings	8	21	45CA
10015	1-1/2"	Hi-Torq 125 Couplings	80	41	45CA
10020	2"	Hi-Torq 125 Couplings	64	38	45CA
10030	3"	Hi-Torq 125 Couplings	36	28	45CA
10040	4"	Hi-Torq 125 Couplings	36	34	45CA
10050	5"	Hi-Torq 125 Couplings	12	21	45CA
10060	6"	Hi-Torq 125 Couplings	12	24	45CA
10080	8"	Hi-Torq 125 Couplings	8	22	45CA
10100	10"	Hi-Torq 125 Couplings	8	25	45CA
10120	12"	Hi-Torq 125 Couplings	8	34	45CA
10150	15"	Hi-Torq 125 Couplings	4	23	45CA

Clamp-All® Tools



Part No.	Size	Description	Carton Qty.	Product Class
99080	80	Hi-Torq 80 wrench	1	45CA
99125	125	Hi-Torq 125 wrench	1	45CA

Snap-All® Increaser/Reducer Transition Bushings



Part No.	Description	Carton Qty.	Weight (lbs.)	Product Class
31575	1-1/2" x 3/4" CU	12/144	29	45CA
30151	1-1/2" x 1" CU	12/144	23	45CA
31512	1-1/2" x 1-1/4" CU	12/144	15	45CA
31515	1-1/2" x 1-1/2" CU	12/144	12	45CA
30215	2" x 1-1/2" CU	6/72	15	45CA
20215	2" x 1-1/2" CI, STL, PVC	6/72	10	45CA
30022	2" x 2" CU, XH	6/72	7	45CA
30032	3" x 2" CU	9/108	50	45CA
20032	3" x 2" CI, STL, PVC	9/108	44	45CA
20325	3" x 2-1/2" CI, STL, PVC	9/108	38	45CA
30033	3" x 3" CU, XH	9/108	15	45CA
30043	4" x 3" CU	5/60	40	45CA
20043	4" x 3" CI, STL, PVC	5/60	34	45CA
30044	4" x 4" CU, XH	5/60	13	45CA
20054	5" x 4" CI, STL, PVC	4/48	40	45CA
20064	6" x 4" CI, STL, PVC	1/12	24	45CA
20065	6" x 5" CI, STL, PVC	1/12	14	45CA
20086	8" x 6" CI, STL, PVC	1/12	34	45CA

FITTINGS & CLAMPS PRODUCTS INDEX

Part No.	Page	Part No.	Page	Part No.	Page	Part No.	Page	Part No.	Page
01-44	178	6P06	172	56-1010	179	533	173	64036H	185
02-43	178	6P07	171	56-1212	179	575	176	64040H	185
02-44	178	6P07S	171	56-2150	179	575P	176	64044H	185
02-55	178	6P08	172	56-E43	179	613P	172	64048H	185
02-64	178	6P09	172	56-E64	179	650	174	64052H	185
02-66	178	6T/C	183	57-125	180	651	175	64056H	185
02-88	178	6T/WOC	183	57-125/125	180	675	176, 177	64064H	185
02-1010	178	6Y/C	183	57-150/125	180	675P	176, 177	64072H	185
02-1212	178	6Y/WOC	183	61P0	170	822-040-16	177	64080H	185
02-1515	178	8MA	182	61P8	172	822-060-16	177	64088H	185
2P41	173	8P01	170	64P01	170	822-080-16	177	64096H	185
2P42	173	8P02	170	64P08	172	880-136	177	64104H	185
2P43	173	8P03	170	84P01	170	880-202	177	81015	187
3C05	175	8P05	171	84P08	172	880-234	177	81020	187
3C06	175	8P06	172	86P01	170	880-237	177	81030	187
3P01	170	8P07	171	86P08	172	880-243	177	81040	187
3P02	170	8P08	172	102	181	880-253	177	81050	187
3P03	170	8P09	172	103	181	880-259	177	81060	187
3P03ST	171	9P03	174	104	181	880-271	177	81080	187
3P04	171	9P04	174	105	181	880-364	177	81100	187
3P05	171	9P06	174	106	181	1219	177	99080	187
3P05R	171	9P07	174	108	181	1220	177	99125	187
3P06	172	9P08	174	150	181	3604	185	1530202	177
3P07	171	9P09	174	200	186	3606	185	1530203	177
3P08	172	9P10	174	200 06 H	186	8051-020-040	177	1530204	177
3P09	172	9P11	174	200 10 H	186	8051-030-060	177	1530302	177
3P11	172	9P12	174	200 12 H	186	8051-040-080	177	1530303	177
3P12	173	9P13	174	200 16 H	186	8051-060-100	177	1530304	177
3P15	173	12MA	182	200 20 H	186	10015	187	1530402	177
3P16	173	31P0	170	200 24 H	186	10020	187	1530403	177
3P17	173	31P8	172	200 28 H	186	10030	187	1530404	177
4C06	175	31POST	170	200 32 H	186	10040	187	1530405	177
4C07	175	33H020 CLAMP	180	200 36 H	186	10050	187	1530602	177
4MA	182	33H032 CLAMP	180	200 40 H	186	10060	187	1530603	177
4P01	170	33H040 CLAMP	180	200 44 H	186	10080	187	1530605	177
4P1X	173	33H056 CLAMP	180	200 48 H	186	10100	187	NC-155000-003	184
4P02	170	33H088 CLAMP	180	200 52 H	186	10120	187	NC-155000-008	184
4P03	170	33H116 CLAMP	180	200 56 H	186	10150	187	NC-155000-009	184
4P03ST	171	33H164 CLAMP	180	200 64 H	186	20032	187	NC-155000-010	184
4P04	171	33H188 CLAMP	180	200 72 H	186	20043	187	NC-155000-011	184
4P05	171	33H212 CLAMP	180	200 80 H	186	20054	187	NC-155000-012	184
4P05R	171	33H250 CLAMP	180	200 88 H	186	20064	187	NC-155000-013	184
4P06	172	33S248 CLAMP	180, 183	200 96 H	186	20065	187	NC-155000-015	184
4P07	171	41P0	170	200 104 H	186	20086	187	NC-155000-016	184
4P08	172	41P8	172	200 128 H	186	20215	187	NC-155000-017	184
4P09	172	41POST	170	200 152 H	186	20325	187	NC-155000-019	184
4P11	172	44U-405	181	200 188 H	186	30022	187	NC-155000-020	184
4PVAF	169, 173	51-44	179	200 212 H	186	30032	187	NC-155000-021	184
4T/C	183	51-66	179	234CDS	175	30033	187	NC-155000-022	184
4T/WOC	183	56-22	179	275	176, 177	30043	187	NC-155000-025	184
4Y/C	183	56-32	179	275P	176, 177	30044	187	NC-155000-027	184
4Y/WOC	183	56-33	179	275PR	176, 177	30151	187	NC-155000-028	184
06-44	178	56-42	179	344CDS	175	30215	187	NC-155000-031	184
06-64	178	56-43	179	351	175	31512	187	NC-155000-032	184
06-66	178	56-44	179	375	176, 177	31515	187	NC-155000-033	184
06-88	178	56-44W	179	375P	176, 177	31575	187	NC-155000-039	184
6C05	175	56-55	179	375PR	176, 177	64006H	185	NC-155000-042	184
6C06	175	56-63	179	413P	172	64008H	185	NCT-1098	184
6MA	182	56-64	179	417P	170	64010H	185	WC100	174
6P01	170	56-66	179	451	175	64012H	185	WC100G	174
6P02	170	56-86	179	475	176, 177	64016H	185	WC100T	174
6P03	170	56-88	179	475P	176, 177	64020H	185	XJ3	180
6P03ST	171	56-125	179	475PR	176, 177	64024H	185		
6P04	171	56-150	179	475R	176, 177	64028H	185		
6P05	171	56-150/125	179	532	173	64032H	185		



ACCESS BOXES



VALVE BOXES

NDS® valve and meter boxes are proudly manufactured in Lindsay, CA, and span a wide variety of sizes, from 6" round to 17" x 30" rectangular. Available with black, green, purple, gray, and sand covers with designations including irrigation control valve, water, sewer, electric, reclaimed water, cable TV, telephone, and others, all NDS boxes and lids contain UV inhibitors for sustained durability and performance in direct sunlight.

NDS® PRO-SPEC™ SERIES VALVE BOXES – NEXT-GENERATION COMMERCIAL GRADE

The NDS Pro-Spec™ Series line is the next generation of valve boxes, ideal for the specification market. These boxes are engineered with unique corrugated sidewalls that provide added strength to the boxes while reducing material and weight. The Pro-Spec™ Series boxes are the strongest in the NDS offering, and they also come with reinforced lids.

Details

- Corrugated sidewalls provide greater strength
- Specification grade valve boxes for professional applications
- Reinforced covers for heavier loads
- Brass nut on boxes for bolt-down capability

Materials and Standards

- High-impact, high-density, injection-molded structural foam polyethylene construction with a melt index between 10-12
- Overlapping covers prevent dirt and grass from settling in between body and cover
- UV inhibitors prevent discoloration and cracking
- 5-year warranty
- Overlapping and drop-in covers available

NDS® STANDARD SERIES VALVE BOXES

Residential/Commercial Grade

NDS valve, meter and access boxes are offered in a wide range of sizes from the 6-inch round valve box to the 17" x 30" rectangular box. They are available with black, green, purple, gray and sand covers with designations including irrigation control valve, water, sewer, electric, reclaimed water, cable TV, telephone and others.

Details

- Covers are identified with ICV (Irrigation Control Valve) designation, unless otherwise specified
- Overlapping covers prevent dirt and grass from settling between body and cover
- The bayonet twist-on cover ensures easy removal on 6-inch and 10-inch round covers
- 6" Snap cover and body available
- The 10-inch round and all rectangular boxes include a brass nut, so bolts may be easily added for lockdown
- UV inhibitors prevent discoloration and deterioration, such as cracking or blistering

Materials and Standards

- Overlapping and drop-in covers available
- Available in round, oval, and rectangular
- One-piece molded of polyolefin with a melt index between 10-12
- UV inhibitors added to aid in preventing discoloration and cracking

NDS PRO-SPEC™ SERIES VALVE BOXES – NEXT-GENERATION COMMERCIAL GRADE

NDS Pro-Spec™ 10" Round Corrugated Valve Boxes

Specifications: The NDS Pro-Spec™ 10" round body is tapered and has a minimum wall thickness of 0.250". The cover seat area has 8 structural support ribs on the underside of the seat, each with a minimum thickness of 0.250". The bottom of the body has a 0.500" flange. The 10" round cover has an average thickness of 0.300". The valve box has a 3/8" Brass nut for the bolt-down as a standard feature.

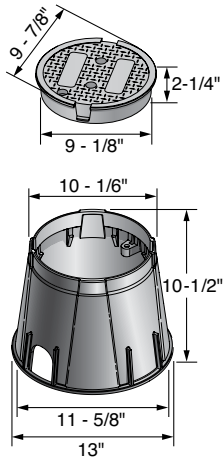

Part No.	Description	Color (Box/Cover)	Pallet Qty.	Weight Ea. (lbs.)	Product Class
Box & Cover					
311BC	10" Round Corrugated Box, Round Overlapping Cover - ICV	Black/Green	132	4.6	20PR
311BCB	10" Round Corrugated Box, Round Overlapping Bolt-Down Cover - ICV	Black/Green	132	4.6	20PR
311BCBLK	10" Round Corrugated Box, Round Overlapping Cover - ICV	Black/Black	132	4.6	20PR
311BCBW	10" Round Corrugated Box, Round Overlapping Bolt-Down Cover - Water	Black/Green	132	4.6	20PR
311BCR	10" Round Corrugated Box, Round Overlapping Cover - Reclaimed Water	Black/Purple	132	4.6	20PR
311BCS	10" Round Corrugated Box, Round Overlapping Cover - Sewer	Black/Green	132	4.6	20PR
311BCW	10" Round Corrugated Box, Round Overlapping Cover - Water	Black/Green	132	4.6	20PR
312BC	10" Round Corrugated Box, Round Overlapping Cover - ICV	Green/Green	132	4.6	20PR
312BC ELEC	10" Round Corrugated Box, Round Overlapping Cover - Electric	Gray/Gray	132	4.6	20PR
312BCB	10" Round Corrugated Box, Round Overlapping Bolt-Down Cover - ICV	Green/Green	132	4.4	20PR
312BCB ELEC	10" Round Corrugated Box, Round Overlapping Bolt-Down Cover - Electric	Gray/Gray	132	4.6	20PR
312BCBS	10" Round Corrugated Box, Round Overlapping Bolt-Down Cover - Sewer	Green/Green	132	4.6	20PR
312BCRBLK	10" Round Overlapping Reclaimed Cover	Black/Black	132	4.7	20PR
312BCRG	10" Round Corrugated Box, Round Overlapping Cover - Reclaimed Water	Green/Green	132	4.6	20PR
312BCS	10" Round Corrugated Box, Round Overlapping Cover - Sewer	Green/Green	132	4.6	20PR
312BCSAND	10" Round Corrugated Box, Round Overlapping Cover - ICV	Sand/Sand	132	4.4	20PR
312BCW	10" Round Corrugated Box, Round Overlapping Cover - Water	Green/Green	132	4.6	20PR
312PBCBR	10" Round Corrugated Box, Round Overlapping Bolt-Down Cover - Reclaimed Water	Purple/Purple	132	4.4	20PR
312PBCR	10" Round Corrugated Box, Round Overlapping Cover - Reclaimed Water	Purple/Purple	132	4.4	20PR
Cover Only					
311C	10" Round Overlapping Cover - ICV	Green	200	1.5	20PR
311C BLK	10" Round Overlapping Cover - ICV	Black	200	1.5	20PR
311C BRN	10" Round Overlapping Cover - ICV	Brown	200	1.5	20PR
311C ELEC	10" Round Overlapping Cover - Electric	Gray	200	1.5	20PR
311CR	10" Round Overlapping Cover - Reclaimed Water	Purple	200	1.4	20PR
311CRG	10" Round Overlapping Cover - Reclaimed Water	Green	200	1.5	20PR
311CS	10" Round Overlapping Cover - Sewer	Green	200	1.5	20PR
311CSAND	10" Round Overlapping Cover - ICV	Sand	200	1.4	20PR
311CW	10" Round Overlapping Cover - Water	Green	200	1.5	20PR
311CW BLK	10" Round Overlapping Cover - Water	Black	200	1.5	20PR
Box Only					
311B	10" Round Corrugated Box	Black	132	3	20PR
312B	10" Round Corrugated Box	Green	132	3	20PR
312PB	10" Round Corrugated Box	Purple	132	3	20PR
113BB	2-1/2" x 3/8" SS Bolt	Steel	n/a	0.1	20NM

NDS PRO-SPEC™ SERIES VALVE BOXES – NEXT-GENERATION COMMERCIAL GRADE

NDS Pro-Spec™ 14" x 19" Rectangular Valve Boxes

Specifications: The NDS Pro-Spec™ 14" x 19" body is tapered and has a minimum wall thickness of 0.187". The body has a double wall at the top cover seat area with a minimum thickness of 0.200". The cover seat area has 18 structural support ribs on the underside of the seat, each with a minimum thickness of 0.200". The bottom of the body has a 0.500" flange. The 14" x 19" cover has an average thickness of 0.200". The valve box has a 3/8" Brass nut for the bolt-down as a standard feature.

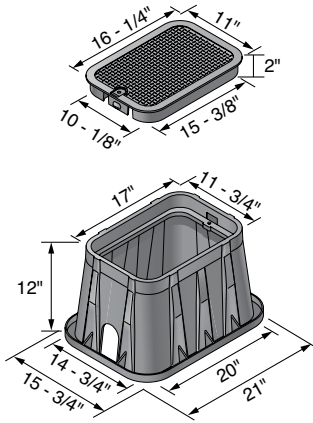

Part No.	Description	Color (Box/Cover)	Pallet Qty.	Weight Ea. (lbs.)	Product Class
Box & Cover					
313BC	14" x 19" Box, Overlapping Cover - ICV	Black/Green	84	8.4	20PR
313BCB	14" x 19" Corrugated Box, Overlapping Bolt-Down Cover - ICV	Black/Green	84	8.5	20PR
313BCBBLK	14" x 19" Corrugated Box, Overlapping Bolt-Down Cover - ICV	Black/Black	84	8.5	20PR
313BCBR	14" x 19" Corrugated Box, Overlapping Bolt-Down Cover - Reclaimed Water	Black/Purple	84	8.5	20PR
313BCBRBLK	14" x 19" Corrugated Box, Overlapping Bolt-Down Cover - Reclaimed Water	Black/Black	84	8.5	20PR
313BCBRG	14" x 19" Corrugated Box, Overlapping Bolt-Down Cover - Reclaimed Water	Black/Green	84	8.5	20PR
313BCBS	14" x 19" Corrugated Box, Overlapping Bolt-Down Cover - Sewer	Black/Green	84	8.5	20PR
313BCBW	14" x 19" Corrugated Box, Overlapping Bolt-Down Cover - Water	Black/Green	84	8.5	20PR
313BCBWBLK	14" x 19" Corrugated Box, Overlapping Bolt-Down Cover - Water	Black/Black	84	8.5	20PR
314BC	14" x 19" Box, Overlapping Cover - ICV	Green/Green	84	8.4	20PR
314BC ARNB	14" x 19" Box, Overlapping Cover - Recycled Water English / Spanish	Black/Black	84	8.4	20PR
314BCB	14" x 19" Corrugated Box, Overlapping Bolt-Down Cover - ICV	Green/Green	84	8.5	20PR
314BCB ELEC	14" x 19" Corrugated Box, Overlapping Bolt-Down Cover - Electric	Gray/Gray	84	8.5	20PR
314BCBRG	14" x 19" Corrugated Box, Overlapping Bolt-Down Cover - Reclaimed Water	Green/Green	84	8.5	20PR
314BCBS	14" x 19" Corrugated Box, Overlapping Bolt-Down Cover - Sewer	Green/Green	84	8.5	20PR
314BCBSAND	14" x 19" Corrugated Box, Overlapping Bolt-Down Cover - ICV	Sand/Sand	84	8.5	20PR
314BCBW	14" x 19" Corrugated Box, Overlapping Bolt-Down Cover - Water	Green/Green	84	8.5	20PR
314BCSAND	14" x 19" Box, Overlapping Cover - ICV	Sand/Sand	84	8.2	20PR
314PBCBR	14" x 19" Corrugated Box, Overlapping Bolt-Down Cover - Reclaimed Water	Purple/Purple	84	8.4	20PR
314PBCR	14" x 19" Box, Overlapping Cover - Reclaimed Water	Purple/Purple	84	7.3	20PR
Cover Only					
313C	14" x 19" Overlapping Cover - ICV	Green	300	2.3	20PR
313C ELEC	14" x 19" Overlapping Cover - Electric	Gray	300	2.3	20PR
313CBLK	14" x 19" Overlapping Cover - ICV	Black	300	2.3	20PR
313CBRN	14" x 19" Overlapping Cover - ICV	Brown	300	2.3	20PR
313CG ELEC	14" x 19" Overlapping Cover - Electric	Green	300	2.3	20PR
313CR	14" x 19" Overlapping Cover - Reclaimed Water	Purple	300	2.3	20PR
313CRBLK	14" x 19" Overlapping Cover - Reclaimed Water	Black	300	2.81	20PR
313CRG	14" x 19" Overlapping Cover - Reclaimed Water	Green	300	2.3	20PR
313CSAND	14" x 19" Overlapping Cover - ICV	Sand	300	2.3	20PR
313CW	14" x 19" Overlapping Cover - Water	Black	300	2.3	20PR
314CS	14" x 19" Overlapping Cover - Sewer	Green	300	2.3	20PR
314CW	14" x 19" Overlapping Cover - Water	Green	300	2.3	20PR
Box Only					
314B	14" x 19" Box	Green	84	5	20PR
314BBLK	14" x 19" Valve Box	Black	84	5.41	20PR
113BB	2-1/2" x 3/8" SS Bolt	Steel	n/a	0.1	20NM

VALVE BOXES

NDS PRO-SPEC™ SERIES VALVE BOXES – NEXT-GENERATION COMMERCIAL GRADE

NDS Pro-Spec™ 13" x 20" Rectangular Valve Boxes

Specifications: The NDS Pro-Spec™ 13" x 20" body is tapered and has a minimum wall thickness of 0.250". The body has a double wall at the top cover seat area with a minimum thickness of 0.250". The cover seat area has 22 structural support ribs on the underside of the seat, each with a minimum thickness of 0.130". The bottom of the body has a 0.500" flange. The 13" x 20" cover has an average thickness of 0.250". The valve box has a 3/8" Brass nut for the bolt-down as a standard feature.

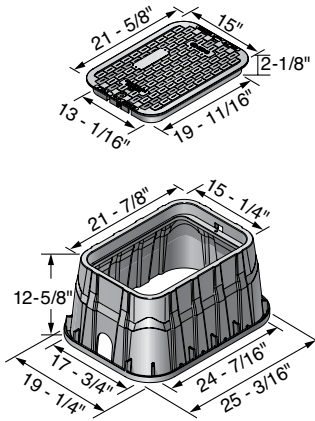

Part No.	Description	Color (Box/Cover)	Pallet Qty.	Weight Ea. (lbs.)	Product Class
Box & Cover					
317BCB	13" x 20" Jumbo Corrugated Box, Overlapping Bolt-Down Cover - ICV	Black/Green	56	14.6	20PR
317BCBBLK	13" x 20" Jumbo Corrugated Box, Overlapping Bolt-Down Cover - ICV	Black/Black	56	14.6	20PR
317BCBS	13" x 20" Jumbo Corrugated Box, Overlapping Bolt-Down Cover - Sewer	Black/Green	56	14.6	20PR
317BCBW	13" x 20" Jumbo Corrugated Box, Overlapping Bolt-Down Cover - Water	Black/Black	56	14.6	20PR
318BC	13" x 20" Jumbo Box, Overlapping Cover - ICV	Green/Green	56	14.6	20PR
318BCB	13" x 20" Jumbo Corrugated Box, Overlapping Bolt-Down Cover - ICV	Black/Green	56	14.6	20PR
318BCBRBLK	13" x 20" Jumbo Corrugated Box, Overlapping Bolt-Down Cover - Reclaimed Water	Black/Black	56	14.6	20PR
318BCBRG	13" x 20" Jumbo Corrugated Box, Overlapping Bolt-Down Cover - Reclaimed Water	Green/Green	56	14.6	20PR
318BCBS	13" x 20" Jumbo Corrugated Box, Overlapping Bolt-Down Cover - Sewer	Green/Green	56	14.6	20PR
318BCBSAND	13" x 20" Jumbo Corrugated Box, Overlapping Bolt-Down Cover - ICV	Sand/Sand	56	14.6	20PR
318BCBW	13" x 20" Jumbo Corrugated Box, Overlapping Bolt-Down Cover - Water	Green/Green	56	14.6	20PR
318PBCBR	13" x 20" Jumbo Corrugated Box, Overlapping Bolt-Down Cover Reclaimed Water	Purple/Purple	56	10.7	20PR
318PBCR	13" x 20" Jumbo Box, Overlapping Cover - Reclaimed Water	Purple/Purple	56	14.6	20PR
Cover Only					
317C	13" x 20" Overlapping Cover - ICV	Green	180	5.1	20PR
317C BLK	13" x 20" Overlapping Cover - ICV	Black	180	5.1	20PR
317C BRN	13" x 20" Overlapping Cover - ICV	Brown	180	5.1	20PR
317CR	13" x 20" Overlapping Cover - Reclaimed Water	Purple	180	5	20PR
317CS	13" x 20" Overlapping Cover - Sewer	Green	180	5.1	20PR
317CSAND	13" x 20" Overlapping Cover - ICV	Sand	180	5	20PR
317CW	13" x 20" Overlapping Cover - Water	Black	180	5.1	20PR
318CW	13" x 20" Overlapping Cover - Water	Green	180	5.1	20PR
Box Only					
318B	13" x 20" Jumbo Box	Green	56	9.2	20PR
318B BLK	13" x 20" Jumbo Box	Black	56	9.2	20PR
318PB	13" x 20" Jumbo Box	Purple	56	9.55	20PR
113BB	2-1/2" x 3/8" SS Bolt	Steel	n/a	0.1	20NM

NDS PRO-SPEC™ SERIES VALVE BOXES – NEXT-GENERATION COMMERCIAL GRADE

NDS Pro-Spec™ 13" x 24" Rectangular Valve Boxes

Specifications: The NDS Pro-Spec™ 13" x 24" body is tapered and has a minimum wall thickness of 0.270". The body has a double wall at the top cover seat area with a minimum thickness of 0.270". The cover seat area has 18 structural support ribs on the underside of the seat, each with a minimum thickness of 0.250". The bottom of the body has a 1.000" flange. The 13" x 24" cover has an average thickness of 0.320". The valve box has a 3/8" Brass nut for the bolt-down as a standard feature.

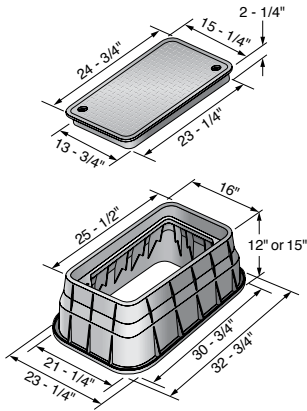

Part No.	Description	Color (Box/Cover)	Pallet Qty.	Weight Ea. (lbs.)	Product Class
Box & Cover					
321BCB	13" x 24" x 12" Box, Overlapping Bolt-Down Cover - ICV	Green/Green	12	24	20PR
321BCB-BG	13" x 24" x 12" Box, Overlapping Bolt-Down Cover - ICV	Black/Green	12	24	20PR
321BCBS	13" x 24" x 12" Box, Overlapping Bolt-Down Cover - Sewer	Green/Green	12	24	20PR
321BCBW	13" x 24" x 12" Box, Overlapping Bolt-Down Cover - Water	Green/Green	12	24	20PR
322BCB	13" x 24" x 15" Box, Overlapping Bolt-Down Cover - ICV	Green/Green	12	24	20PR
322PBCBR	13" x 24" x 12" Box, Overlapping Bolt-Down Cover - Reclaimed Water	Purple/Purple	12	24	20PR
325BCB	13" x 24" x 15" Box, Overlapping Bolt-Down Cover - ICV	Black/Green	12	24	20PR
Cover Only					
322C	13" x 24" Overlapping Cover - ICV	Green	125	7	20PR
322CS	13" x 24" Overlapping Cover - Sewer	Green	125	7	20PR
Box Only					
321B	13" x 24" x 12" Box	Green	12	19	20PR
322B	13" x 24" x 15" Box	Green	12	19	20PR
325B	13" x 24" x 15" Box	Black	12	19	20PR
121BB	3/8" x 3" SS Bolt	Steel	n/a	0.1	20NM

NDS PRO-SPEC™ SERIES VALVE BOXES – NEXT-GENERATION COMMERCIAL GRADE

NDS Pro-Spec™ 17" x 30" Rectangular Valve Boxes

Specifications: The NDS Pro-Spec™ 17" x 30" body is tapered and has a minimum wall thickness of 0.320". The body has a double wall at the top cover seat area with a minimum thickness of 0.320". The cover seat area has 20 structural support ribs on the underside of the seat, each with a minimum thickness of 0.250". The bottom of the body has a 1.000" flange. The 17" x 30" cover has an average thickness of 0.350". The valve box shall have a 3/8" Brass nut for the bolt-down as a standard feature.

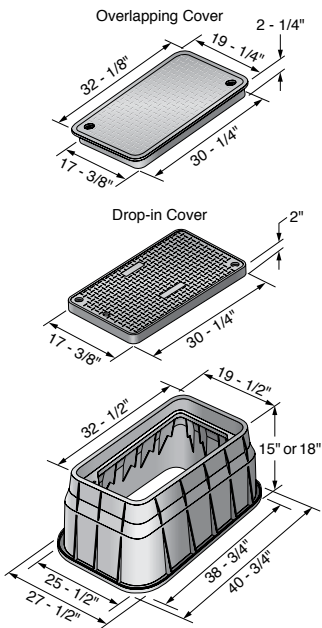

Part No.	Description	Color (Box/Cover)	Pallet Qty.	Weight Ea. (lbs.)	Product Class
Box & Cover					
324BCB	17" x 30" x 15" Box, Overlapping Bolt-Down Cover - ICV	Green/Green	6	28	20PR
324BCB-BG	17" x 30" x 15" Box, Overlapping Bolt-Down Cover - ICV	Black/Green	6	28	20ND
324BCBS	17" x 30" x 15" Box, Overlapping Bolt-Down Cover - Sewer	Green/Green	6	28	20PR
324BCDB	17" x 30" x 15" Box, Drop-in Bolt-Down Cover - ICV	Green/Green	6	28	20PR
326BCB	17" x 30" x 18" Box, Overlapping Bolt-Down Cover - ICV	Green/Green	6	39.3	20PR
326BCB-BG	17" x 30" x 18" Box, Overlapping Bolt-Down Cover - ICV	Black/Green	6	41.2	20ND
326BCDB	17" x 30" x 18" Box, Drop-in Bolt-Down Cover - ICV	Green/Green	6	37	20PR
326BCDB ELEC	17" x 30" x 18" Box, Drop-in Cover - Electric	Gray/Gray	6	37.05	20PR
326BCDB-BG	17" x 30" x 18" Box, Drop-in Bolt-Down Cover - ICV	Black/Green	6	37	20ND
326BCDBW	17" x 30" x 18" Box, Drop-in Bolt-Down Cover - Water	Black/Black	6	37	20ND
326PBCBR	17" x 30" x 18" Box, Overlapping Cover - Reclaimed Water	Purple/Purple	6	38	20PR
Cover Only					
323C	17" x 30" Overlapping Cover - ICV	Green	75	11	20PR
323CD	17" x 30" Drop-in Cover - ICV	Green	75	11	20PR
323CD ELEC	17" x 30" Drop-in Cover - Electric	Gray	75	11	20PR
323CDW	17" x 30" Overlapping Cover - Water	Black	75	11	20PR
323CR	17" x 30" Overlapping Cover - Reclaimed Water	Purple	75	11	20PR
323CS	17" x 30" Overlapping Cover - Sewer	Green	75	11	20PR
Box Only					
324B	17" x 30" x 15" Box	Green	6	20	20NM
324B BLK	17" x 30" x 15" Box	Black	6	20	20NM
326B	17" x 30" x 18" Box	Green	6	23	20NM
326B BLK	17" x 30" x 18" Box	Black	6	23	20NM

NDS STANDARD SERIES VALVE BOXES – RESIDENTIAL/COMMERCIAL GRADE

NDS Standard Series 6" Round Valve Boxes

Specifications: The NDS Standard Series 6" round body is tapered and has a minimum wall thickness of 0.200". The body has a double wall at the top cover seat area with a minimum thickness of 0.130". The bottom of the body has a 0.250" flange. The 6" round cover has an average thickness of 0.187".

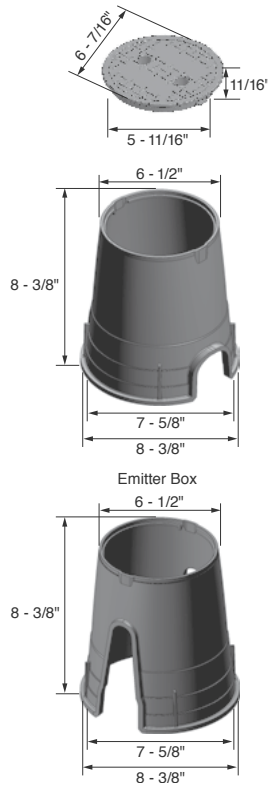

Part No.	Description	Color (Box/Cover)	Pallet Qty.	Weight Ea. (lbs.)	Product Class
Box & Cover					
107BC	6" Round Box, Round Overlapping Cover - ICV	Black/Green	250	1.5	20ND
107BC ARNB	6" Round Box, Round Overlapping Cover - Recycled Water English / Spanish	Black/Black	250	1.5	20ND
107BC BLK	6" Round Box, Round Overlapping Cover - ICV	Black/Black	250	1.5	20ND
107BC CTN	6" Round Box, Round Overlapping Cover - ICV - 4 per carton	Black/Green	108	1.05	20ND
107BC SAND	6" Round Box, Round Overlapping Cover - ICV	Sand/Sand	250	1.5	20ND
107BC SLV	6" Round Box, Round Overlapping Cover - ICV - 20 per sleeve	Black/Green	400	1.5	20ND
107BCH	6" Round Snap-in Valve Box, Round Snap-in Overlapping Cover - ICV	Black/Green	250	1.5	20ND
107BCR	6" Round Box, Round Overlapping Cover - Reclaimed Water	Black/Purple	250	1.5	20ND
107BCR BLK	6" Round Box, Round Overlapping Cover - Reclaimed Water	Black/Black	250	1.5	20ND
107BCS	6" Round Box, Round Overlapping Cover - Sewer	Black/Green	250	1.5	20NM
107BCW	6" Round Box, Round Overlapping Solid Plastic Cover - Water	Black/Green	250	1.5	20NM
107EBC	6" Round Emitter Box, Round Overlapping Cover - Emitter Box	Black/Green	250	1.5	20ND
107EBCR	6" Round Emitter Box, Round Overlapping Cover - Emitter Box	Black/Purple	250	1.5	20ND
107PBCR	6" Round Box, Round Overlapping Cover - Reclaimed Water	Purple/Purple	250	1.5	20ND
108BC	6" Round Box, Round Overlapping Cover - ICV	Green/Green	250	1.5	20ND
108BCS	6" Round Box, Round Overlapping Cover - Sewer	Green/Green	250	1.5	20ND
108BCW	6" Round Box, Round Overlapping Cover - Water	Green/Green	250	1.5	20ND
Cover Only					
107C	6" Round Overlapping Cover - ICV	Green	800	0.36	20ND
107C BLK	6" Round Cover ICV	Black	250	1.5	20ND
107C BRN	6" Round Cover ICV	Brown	250	1.5	20ND
107C SAND	6" Round Overlapping Cover - ICV	Sand	800	0.4	20ND
107CH	6" Round Snap-in Overlapping Cover - ICV	Green	1200	0.35	20ND
107CR	6" Round Overlapping Cover - Reclaimed Water	Purple	800	0.4	20ND
107CS	6" Round Overlapping Cover - Sewer	Green	800	0.4	20NM
107CW	6" Round Overlapping Cover - Water	Green	800	0.4	20NM
Box Only					
106B	6" Round Snap-in Valve Box	Black	250	0.9	20ND
107B	6" Round Box	Black	250	1.23	20ND
108B	6" Round Box	Green	250	1.23	20ND

VALVE BOXES

NDS STANDARD SERIES VALVE BOXES – RESIDENTIAL/COMMERCIAL GRADE

NDS Standard Series 10" Round Valve Boxes

Specifications: The NDS Standard Series 10" round body is tapered and has a minimum wall thickness of 0.200". The cover seat area has 6 structural support ribs on the underside of the seat, each with a minimum thickness of 0.250". The bottom of the body has a 0.500" flange. The 10" round cover has an average thickness of 0.250". The valve box has a 5/16" Brass nut for the bolt-down as a standard feature.

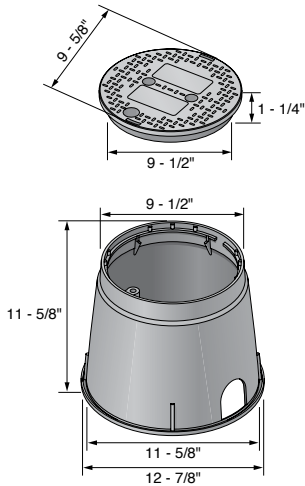

Part No.	Description	Color (Box/Cover)	Pallet Qty.	Weight Ea. (lbs.)	Product Class
Box & Cover					
111BC	10" Round Box, Round Overlapping Cover - ICV	Black/Green	180	3	20ND
111BC BLK	10" Round Box, Round Overlapping Cover - ICV	Black/Black	180	3	20ND
111BC CTN	10" Round Box, Round Overlapping Cover - ICV - 4 per carton	Black/Green	72	3.9	20ND
111BC SAND	10" Round Box, Round Overlapping Cover - ICV	Sand/Sand	180	3.2	20ND
111BCB	10" Round Box, Round Overlapping Bolt-Down Cover - ICV	Black/Green	180	3	20ND
111BCBW	10" Round Box, Round Overlapping Bolt-Down Cover - Water	Black/Black	180	3	20NM
111BCR	10" Round Box, Round Overlapping Cover - Reclaimed Water	Black/Purple	180	3	20ND
111BCR BLK	10" Round Box, Round Overlapping Cover - Reclaimed Water	Black/Purple	180	3	20ND
111BCS	10" Round Box, Round Overlapping Cover - Sewer	Black/Green	180	3	20NM
111BCW	10" Round Box, Round Overlapping Cover - Water	Black/Green	180	3	20NM
111PBCR	10" Round Box, Round Overlapping Cover - Reclaimed Water	Purple/Purple	180	3	20ND
112BC	10" Round Box, Round Overlapping Cover - ICV	Green/Green	180	3	20ND
112BCB	10" Round Box, Round Overlapping Bolt-Down Cover - ICV	Green/Green	180	3	20ND
112BCRG	10" Round Box, Round Overlapping Cover - Reclaimed Water	Green/Green	180	3	20ND
112BCS	10" Round Box, Round Overlapping Cover - Sewer	Green/Green	180	3.9	20NM
112BCW	10" Round Box, Round Overlapping Cover - Water	Green/Green	180	3.9	20NM
Cover Only					
111C	10" Round Overlapping Cover - ICV	Green	300	0.95	20ND
111C BLK	10" Round Overlapping Cover - ICV	Black	300	0.95	20ND
111C BRN	10" Round Overlapping Cover - ICV	Brown	300	0.95	20ND
111C SAND	10" Round Overlapping Cover - ICV	Sand	300	0.95	20ND
111CR	10" Round Overlapping Cover - Reclaimed Water	Purple	300	1	20ND
111CRG	10" Round Overlapping Cover - Reclaimed Water	Green	300	0.95	20ND
111CS	10" Round Overlapping Cover - Sewer	Green	300	1	20NM
111CW BLK	10" Round Overlapping Cover - Water	Black	300	0.95	20ND
111CW	10" Round Overlapping Cover - Water	Green	300	1	20NM
Box Only					
111B	10" Round Box	Black	180	2	20NM
111BBX2	1-3/4" x 5/16" SS Bolt	Steel	n/a	0.05	90WP
111BB	1-1/4" x 5/16" SS Bolt	Steel	n/a	0.05	20ND
112B	10" Round Box	Green	300	2	20ND

NDS STANDARD SERIES VALVE BOXES – RESIDENTIAL/COMMERCIAL GRADE

NDS Standard Series 14" x 19" Rectangular Valve Boxes

Specifications: The NDS Standard Series 14" x 19" body is tapered and has a minimum wall thickness of 0.200". The body has a double wall at the top cover seat area with a minimum thickness of 0.250". The cover seat area has 16 structural support ribs on the underside of the seat, each with a minimum thickness of 0.250". The bottom of the body has a 0.500" flange. The 14" x 19" cover has an average thickness of 0.250". The valve box has a 3/8" Brass nut for the bolt-down as a standard feature

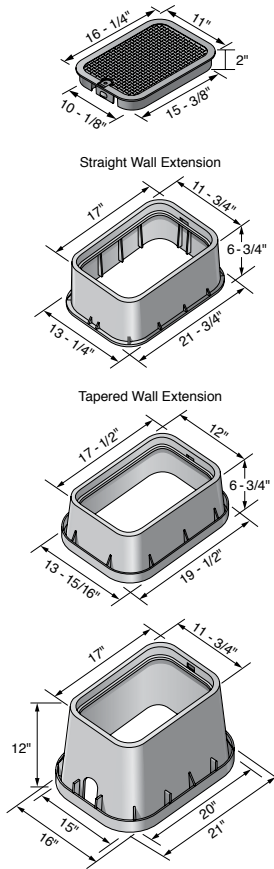

Part No.	Description	Color (Box/Cover)	Pallet Qty.	Weight Ea. (lbs.)	Product Class
Box & Cover					
115	14" x 19" x 6" Extension, Overlapping Cover - ICV	Black/Green	49	16.16	20ND
116	14" x 19" x 6" Extension, Overlapping Cover - ICV	Green/Green	49	6.16	20ND
113BC	14" x 19" Box, Overlapping Cover - ICV	Black/Green	78	9.1	20ND
113BC CTN	14" x 19" Valve Box Overlap ICV Cover	Black/Green	48	9.32	20ND
113BC SAND	14" x 19" Box, Overlapping Cover - ICV	Sand/Sand	78	9.25	20ND
113BCBLK	14" x 19" Box, Overlapping Cover - ICV	Black/Black	78	9.1	20ND
113BCD	14" x 19" Box, Drop-in Cover - ICV	Black/Green	78	8	20ND
113BCE	14" x 19" Box, Overlapping Cover - Electrical	Black/Green	78	9.32	20NM
113BCR	14" x 19" Box, Overlapping Cover - Reclaimed Water	Black/Purple	78	9.1	20ND
113BCRBLK	14" x 19" Box, Overlapping Cover - Reclaimed Water	Black/Black	78	9.1	20ND
113BCRG	14" x 19" Box, Overlapping Cover - Reclaimed Water	Black/Green	78	9.1	20ND
113BCS	14" x 19" Box, Overlapping Cover - Sewer	Black/Green	78	9.1	20ND
113BCW	14" x 19" Box, Overlapping Bolt-Down Cover - Water	Black/Black	300	9.32	20NM
113BCWG	14" x 19" Box, Overlapping Cover - Water	Black/Green	78	9.1	20ND
113PBCR	14" x 19" Box, Overlapping Cover - Reclaimed Water	Purple/Purple	78	9.29	20ND
114BC	14" x 19" Box, Overlapping Cover - ICV	Green/Green	78	9.95	20ND
114BCS	14" x 19" Box, Overlapping Cover - Sewer	Green/Green	78	9.95	20NM
114BCW	14" x 19" Box, Overlapping Cover - Water	Green/Green	78	9.95	20NM
115BCR	14" x 19" x 6" Box, Overlapping Cover - ICV	Black/Purple	42	7.29	20ND
115TBC	14" x 19" x 6" Tapered Box, Overlapping Cover - ICV	Black/Green	96	6	20ND
116TBC	14" x 19" x 6" Tapered Box, Overlapping Cover - ICV	Green/Green	96	5.55	20ND
116TBC SAND	14" x 19" x 6" Tapered Box, Overlapping Cover - ICV	Sand/Sand	96	6.16	20ND
Cover Only					
113C	14" x 19" Overlapping Cover - ICV	Green	300	2	20ND
113C BRN	14" x 19" Overlapping Cover - ICV	Brown	300	2	20ND
113C SAND	14" x 19" Overlapping Cover - ICV	Sand	300	2	20ND
113CB	14" x 19" Overlapping Cover - ICV	Black	300	2	20ND
113CE	14" x 19" Overlapping Cover - Electrical	Green	300	2.3	20NM
113CR	14" x 19" Overlapping Cover - Reclaimed Water	Purple	300	2.5	20ND
113CRB	14" x 19" Overlapping Cover - Reclaimed Water	Black	300	2	20ND
113CRG	14" x 19" Overlapping Cover - Reclaimed Water	Green	300	2	20ND
113CS	14" x 19" Overlapping Cover - Sewer	Green	300	2	20ND
113CW	14" x 19" Overlapping Cover - Water	Black	300	2	20ND
114CW	14" x 19" Overlapping Cover - Water	Green	300	2	20ND
Box Only					
113-6	14" x 19" x 6" Extension	Black	49	4.1	20ND
113B	14" x 19" Box	Black	78	6.03	20NM
114-6	14" x 19" x 6" Rectangular Extension	Green	49	3.86	20ND
114B	14" x 19" Box	Green	78	6.1	20ND
116-SAND	14" x 19" x 6" Extension	Sand	49	6	20ND
113BB	2-1/2" x 3/8" SS Bolt	Steel	n/a	0.1	20NM

NDS STANDARD SERIES VALVE BOXES – RESIDENTIAL/COMMERCIAL GRADE

NDS Standard Series 13" x 20" Rectangular Valve Boxes

Specifications: The NDS Standard Series 13" x 20" body is tapered and has a minimum wall thickness of 0.250". The body has a double wall at the top cover seat area with a minimum thickness of 0.250". The cover seat area has 16 structural support ribs on the underside of the seat, each with a minimum thickness of 0.250". The bottom of the body has a 0.500" flange. The 13" x 20" cover has an average thickness of 0.250". The valve box has a 3/8" Brass nut for the bolt-down as a standard feature.

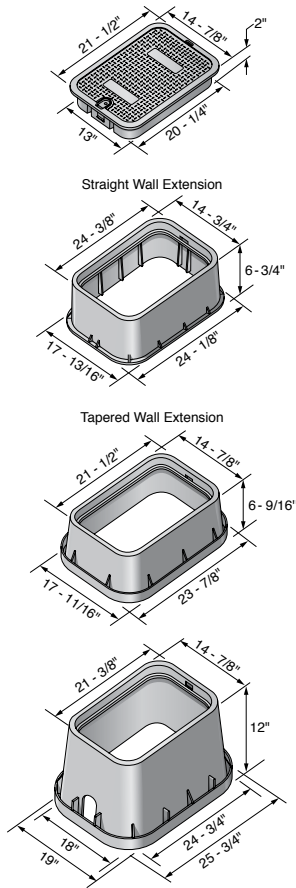

Part No.	Description	Color (Box/Cover)	Pallet Qty.	Weight Ea. (lbs.)	Product Class
Box & Cover					
119	13" x 20" x 6" Jumbo Extension, Overlapping Cover - ICV	Black/Green	32	12	20ND
120	13" x 20" x 6" Jumbo Extension, Overlapping Cover - ICV	Green/Green	32	12	20ND
117BC	13" x 20" Jumbo Box, Overlapping Cover - ICV	Black/Green	56	14	20ND
117BC BLK	13" x 20" Jumbo Box, Overlapping Cover - ICV	Black/Black	56	14	20ND
117BC SAND	13" x 20" Jumbo Box, Overlapping Cover - ICV	Sand/Sand	56	14	20ND
117BCD	13" x 20" Jumbo Box, Overlapping Cover - ICV	Black/Green	56	14	20ND
117BCR	13" x 20" Jumbo Box, Overlapping Cover - Reclaimed Water	Black/Black	56	14	20ND
117BCS	13" x 20" Jumbo Box, Overlapping Cover - Sewer	Black/Green	56	14	20NM
117BCW	13" x 20" Jumbo Box, Overlapping Cover - Water	Black/Black	56	14	20ND
117PBCR	13" x 20" Jumbo Box, Overlapping Cover - Reclaimed Water	Purple/Purple	56	14	20ND
118BC	13" x 20" Jumbo Box, Overlapping Cover - ICV	Green/Green	56	14	20ND
118BCS	13" x 20" Jumbo Box, Overlapping Cover - Sewer	Green/Green	56	14	20ND
118BCW	13" x 20" Jumbo Box, Overlapping Cover - Water	Green/Green	56	14	20ND
118TBC	13" x 20" x 6" Tapered Box, Overlapping Cover - ICV	Green/Green	56	11.15	20ND
119 SAND	13" x 20" x 6" Jumbo Extension, Overlapping Cover - ICV	Sand/Sand	32	10.95	20ND
119TBC	13" x 20" x 6" Tapered Box, Overlapping Cover - ICV	Black/Green	56	11.15	20ND
119TBCR	13" x 20" Tapered Box, Overlapping Cover - Reclaimed Water	Black/Purple	56	11.15	20ND
Cover Only					
117C	13" x 20" Overlapping Cover - ICV	Green	180	5.3	20ND
117C BRN	13" x 20" Overlapping Cover - ICV	Brown	180	5.3	20ND
117C SAND	13" x 20" Overlapping Cover - ICV	Sand	180	5	20ND
117CB	13" x 20" Overlapping Cover - ICV	Black	180	5.3	20ND
117CR	13" x 20" Overlapping Cover - Reclaimed Water	Purple	180	5.3	20ND
117CS	13" x 20" Jumbo Overlapping Cover - Sewer	Green	180	5	20NM
117CW	13" x 20" Overlapping Cover - Water	Black	180	5.3	20ND
118CW	13" x 20" Overlapping Cover - Water	Green	180	5.3	20ND
Box Only					
117-6	13" x 20" x 6" Jumbo Extension	Black	32	6.88	20ND
117B	13" x 20" Jumbo Box	Black	56	9.65	20NM
118-6	13" x 20" x 6" Jumbo Extension	Green	32	6.88	20ND
118B	13" x 20" Jumbo Box	Green	56	9.65	20NM
113BB	2-1/2" x 3/8" SS Bolt	Steel	n/a	0.1	20NM

NDS STANDARD SERIES VALVE BOXES – RESIDENTIAL GRADE

NDS 6" Round Valve Boxes

Specifications: NDS 6" round body is tapered and has a minimum wall thickness of 0.130". The body has a double wall at the top cover seat area with a minimum thickness of 0.125". The bottom of the body has a 0.250" flange. The 6" round cover has an average thickness of 0.150".

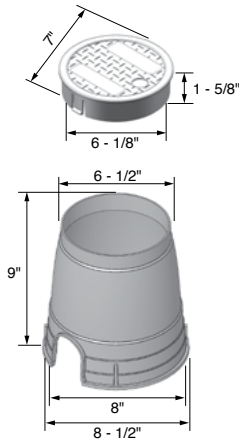

Part No.	Description	Color (Box/Cover)	Pallet Qty.	Weight Ea. (lbs.)	Product Class
Box & Cover					
D108-G	6" Valve Box and Overlapping Cover - ICV	Green/Green	600	1.2	20ND
D109-G	6" Round Box, 6" Round Cover - ICV	Black/Green	600	1.2	20ND
D109-P	6" Round Box, 6" Round Cover - Reclaimed Water	Black/Purple	600	1.21	20ND
D109-GBOX	6" Round Box, 6" Round Cover - ICV	Black/Green	36 Box/ 900 Pal.	1.2	20ND
Cover Only					
D109-GL	6" Round Cover - ICV	Green	600	0.4	20ND
D109-PL	6" Round Cover - Reclaimed Water	Purple	600	0.4	20ND
Box Only					
D109-B/O	6" Round Box	Black	600	0.8	20ME

NDS 8" x 12" Oval Valve Boxes

Specifications: NDS 8" x 12" body is tapered and has a minimum wall thickness of 0.187". The body has a double wall at the top cover seat area with a minimum thickness of 0.200". The cover seat area has 10 structural support ribs on the underside of the seat, each with a minimum thickness of 0.150". The bottom of the body has a 0.375" flange. The 8" x 12" cover shall have an average thickness of 0.150".

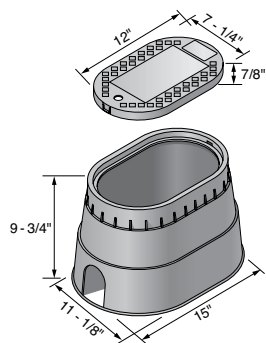

Part No.	Description	Color (Box/Cover)	Pallet Qty.	Weight Ea. (lbs.)	Product Class
Box & Cover					
M2-SG	8" x 12" Box, Drop-in Cover - Control Valve	Black/Green	132	4	20ND
Cover Only					
M2-SG-LID	8" x 12", Drop-in Cover	Green	132	0.719	20ND

VALVE BOXES

NDS STANDARD SERIES VALVE BOXES – RESIDENTIAL GRADE

NDS 8" x 14" Oval Valve Boxes

Specifications: NDS 8" x 14" body is tapered and has a minimum wall thickness of 0.187". The body has a double wall at the top cover seat area with a minimum thickness of 0.200". The cover seat area has 10 structural support ribs on the underside of the seat, each with a minimum thickness of 0.150". The bottom of the body has a 0.375" flange. The 8" x 14" cover has an average thickness of 0.150".

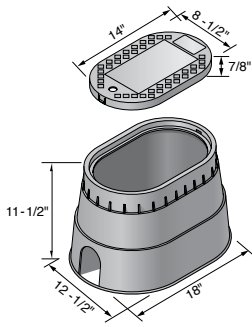

Part No.	Description	Color (Box/Cover)	Pallet Qty.	Weight Ea. (lbs.)	Product Class
Box & Cover					
M4-SG	8" x 14" Box, Drop-in Cover - Control Valve	Black/Green	96	4.6	20ND

NDS 10" x 15" Rectangular Valve Boxes

Specifications: NDS 10" x 15" x 10" body is tapered and has a minimum wall thickness of 0.130". The body has a double wall at the top cover seat area with a minimum thickness of 0.200". The cover seat area has 12 structural support ribs on the underside of the seat, each with a minimum thickness of 0.130". The bottom of the body has a 0.750" flange. The D1000 cover has an average thickness of 0.187". NDS D1000 valve boxes and covers are injection molded of structural foam recycled polyolefin material with a melt index between 10-12. Coloring and UV stabilizers are added, along with processing lubricants when needed.

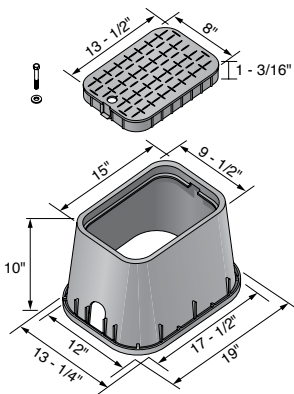

Part No.	Description	Color (Box/Cover)	Pallet Qty.	Weight Ea. (lbs.)	Product Class
Box & Cover					
D1000-SG	10" x 15" x 10" Box, Drop-in Cover - Valve Box	Black/Green	96	4.8	20ND
Cover Only					
D1000-SGL	10" x 15" Drop-in Cover - Valve Box	Green	360	1.4	20ND
Box Only					
D1000-B/O	10" x 15" x 10" Box	Black	96	3.4	20ME

VALVE BOXES PRODUCTS INDEX

Part No.	Page	Part No.	Page	Part No.	Page	Part No.	Page	Part No.	Page
106B	197	112BCB	198	117CB	200	313BCB	193	318CW	194
107B	197	112BCRG	198	117C BRN	200	313BCBLK	193	318PB	194
107BC	197	112BCS	198	117CR	200	313BCBR	193	318PBCBR	194
107BC ARNB	197	112BCW	198	117CS	200	313BCBRBLK	193	318PBCR	194
107BC BLK	197	113-6	199	117C SAND	200	313BCBRG	193	321B	195
107BC CTN	197	113B	199	117CW	200	313BCBS	193	321BCB	195
107BCH	197	113BB 192, 193, 194, 199, 200	200	117PBCR	200	313BCBW	193	321BCB-BG	195
107BCR	197	113BC	199	118-6	200	313BCBWBLK	193	321BCBS	195
107BCR BLK	197	113BCBLK	199	118B	200	313C	193	321BCBW	195
107BCS	197	113BC CTN	199	118BC	200	313CBLK	193	322B	195
107BC SAND	197	113BCD	199	118BCS	200	313CBRN	193	322BCB	195
107BC SLV	197	113BCE	199	118BCW	200	313C ELEC	193	322C	195
107BCW	197	113BCR	199	118CW	200	313CG ELEC	193	322CS	195
107C	197	113BCRBLK	199	118TBC	200	313CR	193	322PBCBR	195
107C BLK	197	113BCRG	199	119	200	313CRBLK	193	323C	196
107C BRN	197	113BCS	199	119 SAND	200	313CRG	193	323CD	196
107CH	197	113BC SAND	199	119TBC	200	313CSAND	193	323CD ELEC	196
107CR	197	113BCW	199	119TBCR	200	313CW	193	323CDW	196
107CS	197	113BCWG	199	120	200	314B	193	323CR	196
107C SAND	197	113C	199	121BB	195	314BBLK	193	323CS	196
107CW	197	113CB	199	311B	192	314BC	193	324B	196
107EBC	197	113C BRN	199	311BC	192	314BC ARNB	193	324B BLK	196
107EBCR	197	113CE	199	311BCB	192	314BCB	193	324BCB	196
107PBCR	197	113CR	199	311BCBLK	192	314BCB ELEC	193	324BCB-BG	196
108B	197	113CRB	199	311BCBW	192	314BCBRG	193	324BCBS	196
108BC	197	113CRG	199	311BCR	192	314BCBS	193	324BCDB	196
108BCS	197	113CS	199	311BCS	192	314BCBSAND	193	325B	195
108BCW	197	113C SAND	199	311BCW	192	314BCBW	193	325BCB	195
111B	198	113CW	199	311C	192	314BCSAND	193	326B	196
111BB	198	113PBCR	199	311C BLK	192	314CS	193	326B BLK	196
111BBX2	198	114-6	199	311C BRN	192	314CW	193	326BCB	196
111BC	198	114B	199	311C ELEC	192	314PBCBR	193	326BCB-BG	196
111BCB	198	114BC	199	311CR	192	314PBCR	193	326BCDB	196
111BC BLK	198	114BCS	199	311CRG	192	317BCB	194	326BCDB-BG	196
111BCBW	198	114BCW	199	311CS	192	317BCBBLK	194	326BCDB ELEC	196
111BC CTN	198	114CW	199	311CSAND	192	317BCBS	194	326BCDBW	196
111BCR	198	115	199	311CW	192	317BCBW	194	326PBCBR	196
111BCR BLK	198	115BCR	199	311CW BLK	192	317C	194	D108-G	201
111BCS	198	115TBC	199	312B	192	317C BLK	194	D109-B/O	201
111BC SAND	198	116	199	312BC	192	317C BRN	194	D109-G	201
111BCW	198	116-SAND	199	312BCB	192	317CR	194	D109-GBOX	201
111C	198	116TBC	199	312BCB ELEC	192	317CS	194	D109-GL	201
111C BLK	198	116TBC SAND	199	312BCBS	192	317CSAND	194	D109-P	201
111C BRN	198	117-6	200	312BC ELEC	192	317CW	194	D109-PL	201
111CR	198	117B	200	312BCRBLK	192	318B	194	D1000-B/O	202
111CRG	198	117BC	200	312BCRG	192	318B BLK	194	D1000-SG	202
111CS	198	117BC BLK	200	312BCS	192	318BC	194	D1000-SGL	202
111C SAND	198	117BCD	200	312BCSAND	192	318BCB	194	M2-SG	201
111CW	198	117BCR	200	312BCW	192	318BCBRBLK	194	M2-SG-LID	201
111CW BLK	198	117BCS	200	312PB	192	318BCBRG	194	M4-SG	202
111PBCR	198	117BC SAND	200	312PBCBR	192	318BCBS	194		
112B	198	117BCW	200	312PBCR	192	318BCBSAND	194		
112BC	198	117C	200	313BC	193	318BCBW	194		

NDS AUTOMATIC METER READER (AMR) BOXES – STANDARD COMMERCIAL GRADE



Superior signal transmission versus products made of concrete materials or cast iron.

Lighter weight material eases installation and lowers freight and handling costs.

Designed specifically for the Automatic Meter reading industry, the newest line of AMR boxes builds on the NDS tradition of strength, durability and value. Like our current automatic Meter Reading products, this new line of AMR boxes and covers are injection-molded of polyoefins and contain UV inhibitors to prevent discoloration and cracking.

Bottom Mounts

- Concealed antennae are completely protected from landscape equipment damage and are less likely to draw attention from vandals
- Exceptional antennae signal transmissions
- Offset cavities eliminate the physical interference between antennae and meter
- Bracket accommodates a majority of the industry antennae

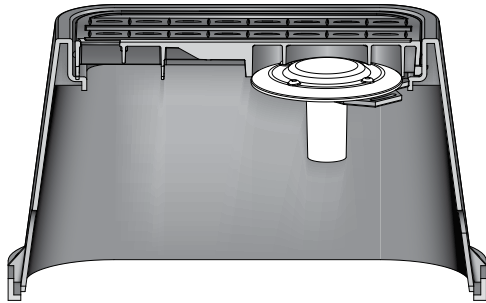

Single AMR bottom mount
(pre-assembled bracket)

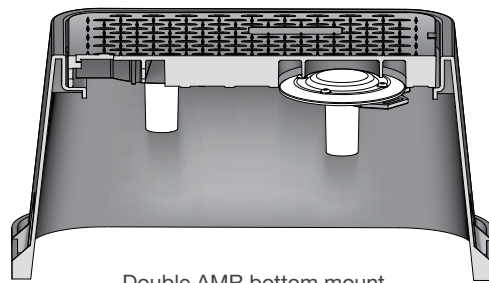

Double AMR bottom mount
(pre-assembled bracket)

Top Mounts

- Recess reduces the probability of damage caused by landscape equipment and vandals
- Offset recesses eliminate the physical interference between the antennae and meter
- Recess and holes accommodate most of the industry antennae
- Compatible with many of the industry Touch Read antennae

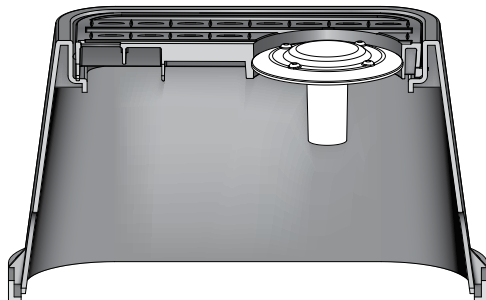

Single AMR top mount

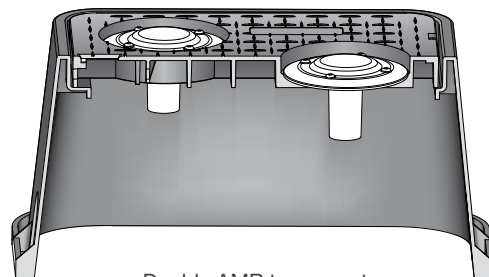

Double AMR top mount

NDS AUTOMATIC METER READER (AMR) BOXES – STANDARD COMMERCIAL GRADE

NDS 14" x 19" AMR Meter Boxes & Covers

Specifications: NDS 14" x 19" AMR meter boxes and covers are injection molded of structural foam recycled polyolefin material with a melt index between 10-12. Coloring and UV stabilizers are added, along with processing lubricants when needed. NDS 14" x 19" x 12" body is tapered and has a minimum wall thickness of 0.250". The body has a double wall at the top cover seat area with a minimum thickness of 0.187". The cover seat area has 30 structural support ribs on the underside of the seat, each with a minimum thickness of 3/16". The bottom of the body has a 1" flange. The 14" x 19" cover has a minimum thickness of 0.250".

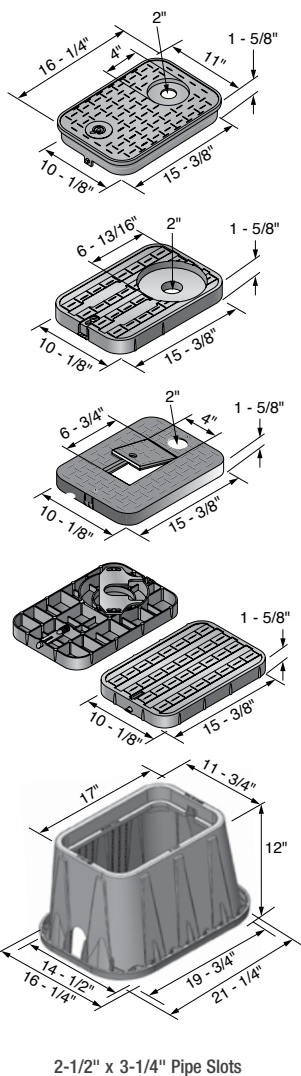

Part No.	Description - Marking	Color (Box/Cover)	Pallet Qty.	Wt. Ea. lbs.	Product Class
Drop-in Box & Cover					
D12-BAMR	14" x 19" x 12" Box, Drop-in Locking Solid Plastic, Single Bottom Mount AMR Bracket Cover - Water Meter	Black/Black	72	8.90	20ME
D12-TAMR	14" x 19" x 12" Box, Drop-in Locking Solid Plastic, Single 2" AMR/TR Hole w/ 7" Top Recess Cover - Water Meter	Black/Black	72	9.22	20ME
D1200-DITR	14" x 19" x 12" Box, Drop-in Solid Plastic, Single 2" AMR/TR Hole Cover - Water Meter	Black/Black	72	9.00	20ME
Overlapping Box & Cover					
D12AMR-OLLOCTRBLUL	14" x 19" Blue Overlapping Solid Plastic, Single 1.75" AMR/TR Hole w/ 4" Top Recess Cover - Water Meter	Blue	100	2.80	20ME
D1200-OLTR	14" x 19" x 12" Box, Overlapping Solid Plastic, Single 2" AMR/TR Hole Cover - Water Meter	Black/Black	72	9.20	20ME
Drop-in Cover Only					
D12-BAMRL	14" x 19" Drop-in Locking Solid Plastic, Single Bottom Mount AMR Bracket Cover - Water Meter	Black	100	2.10	20ME
D12-TAMRL	14" x 19" Drop-in Locking Solid Plastic, Single 2" AMR/TR Hole w/ 7" Top Recess Cover - Water Meter	Black	100	2.42	20ME
D1200-DITRL	14" x 19" Drop-in Solid Plastic, Single 2" AMR/TR Hole Cover - Water Meter	Black	100	2.20	20ME
D12-TAMRBLUL	12" x 17" AMR Top Mount Locking Lid	Blue	100	2.42	20ME
Overlapping Cover Only					
D12AMR-OLLOCL	14" x 19" Overlapping Solid Plastic, Single 4" Top Recess Cover - Water Meter	Black	100	2.80	20ME
D12AMR-OLLOCTRL	14" x 19" Overlapping Solid Plastic, Single 1.75" AMR/TR Hole w/ 4" Top Recess Cover - Water Meter	Black	100	2.80	20ME
Box Only					
D1200-B/O	14" x 19" x 12" Box	Black	72	6.80	20ME
D600E-EXT	14" x 19" x 6" Extension	Black	42	4.20	20ME
D1800-B/O	14" x 19" x 18" Box	Black	48	10.00	20ME
Box with Overlapping Cover					
D600E-DISG	12" x 6" Extension Drop-in Solid Plastic Cover	Black/Green	42	6.40	20ME

NDS AUTOMATIC METER READER (AMR) BOXES – STANDARD COMMERCIAL GRADE

NDS 13" x 20" AMR Boxes & Covers

Specifications: NDS 13" x 20" AMR meter boxes and covers are injection molded of structural foam recycled polyolefin material with a melt index between 10-12. Coloring and UV stabilizers are added, along with processing lubricants when needed. The 13" x 20" body is tapered and has a minimum wall thickness of 0.250". The body has a double wall at the top cover seat area with a minimum thickness of 0.187". The cover seat area has 30 structural support ribs on the underside of the seat, each with a minimum thickness of 3/16". The bottom of the body has a 1" flange. The 14" x 19" cover has an average thickness of 0.250".

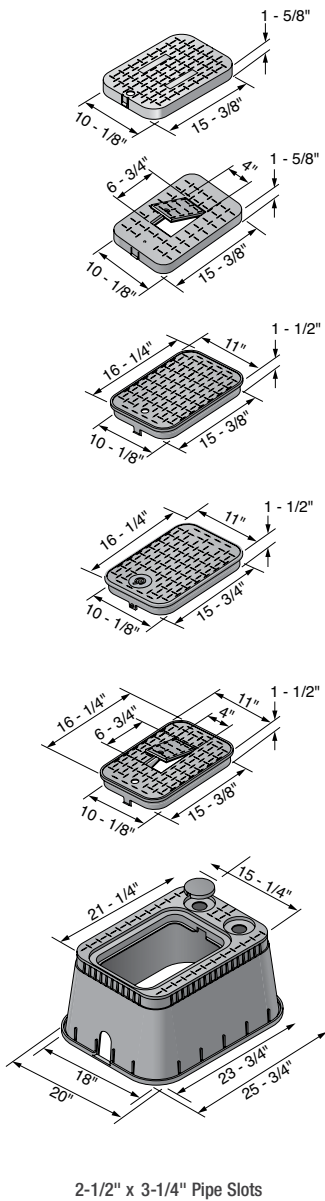

METER BOXES

Part No.	Description - Marking	Color (Box/Cover)	Pallet Qty.	Wt. Ea. lbs.	Product Class
Drop-in Box & Cover					
D15AMR2-DI	13" x 20" x 12" Jumbo AMR Box, Drop-in Solid Plastic Cover - Water Meter	Black/Black	48	16.20	20ME
D1200-DICIRBLU	12" x 17" Box with Drop-in Plastic Cover with cast Iron Meter Reader	Black/Blue	72	10.20	20ME
Overlapping Box & Cover					
D15AMR2-OLLOC	13" x 20" x 12" Jumbo AMR Box, Overlapping Locking Solid Plastic Cover - Water Meter	Black/Black	48	16.60	20ME
D15AMR2-OLR	13" x 20" x 12" Jumbo AMR Box, Overlapping Meter Reader Plastic w/ Plastic Reader Cover - Water Meter	Black/Black	48	16.40	20ME
Drop-in Cover Only					
D1200-DISBL	14" x 19" Drop-in Solid Plastic Cover - Water Meter	Black	216	2.20	20ME
D1200-DIRBL	14" x 19" Drop-in Meter Reader Plastic w/ Plastic Reader Cover - Water Meter	Black	216	2.20	20ME
D1200-DICIRLID	14" x 19" Drop-in Meter Reader Plastic w/ Cast Iron Reader Cover - Water Meter	Black	216	3.40	20ME
Overlapping Cover Only					
D1200-OLSBL	14" x 19" Overlapping Solid Plastic Cover - Water Meter	Black	216	2.40	20ME
D1200-OLLOCBLD	14" x 19" Overlapping Locking Solid Plastic Cover - Water Meter	Black	100	2.60	20ME
Box Only					
D15AMR2-B/O	13" x 20" x 12" Jumbo AMR Box with No Pipe Slots	Black	48	12.09	20ME
D15AMR2-DU B/O	13" x 20" x 12" Jumbo AMR Box with Dual Pipe Slots Reader End	Black	48	10.20	20ME
D15AMR2-PS B/O	Jumbo AMR Box with Pipe Slots	Black	48	10.20	20ME

NDS AUTOMATIC METER READER (AMR) BOXES – STANDARD COMMERCIAL GRADE

NDS 13" x 20" Jumbo Boxes & AMR Covers

Specifications: NDS 13" x 20" meter boxes and AMR covers are injection molded of structural foam recycled polyolefin material with a melt index between 10-12. Coloring and UV stabilizers are added, along with processing lubricants when needed. The 13" x 20" body is tapered and has a minimum wall thickness of 0.250". The body has a double wall at the top cover seat area with a minimum thickness of 0.187". The cover seat has 56 structural support ribs on the underside of the seat, each with a minimum thickness of 1/50". The bottom of the body has a 1" flange. The 13" x 20" cover has an average thickness of 0.25".

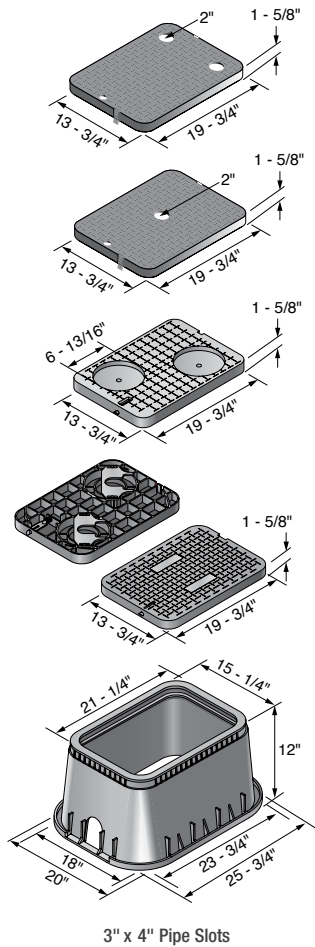

Part No.	Description - Marking	Color (Box/Cover)	Pallet Qty.	Wt. Ea. lbs.	Product Class
Drop-in Box & Cover					
D15-BAMR	13" x 20" x 12" Jumbo Box, Drop-in Locking Solid Plastic w/ Double Bottom Mount AMR Brackets Cover - Water Meter	Black/Black	48	24.40	20ME
D15DU-BAMR	13" x 20" x 12" Dual Pipe Slot Box, Drop-in Locking Solid Plastic w/ Double Bottom Mount AMR Brackets Cover - Water Meter	Black/Black	48	23.91	20ME
D1500-DISBTR	13" x 20" x 12" Jumbo Box, Drop-in Solid Plastic w/ Single Custom AMR/TR Hole Cover - Water Meter	Black/Black	48	13.20	20ME
Drop-in Cover Only					
D15-BAMRL	13" x 20" Drop-in Locking Solid Plastic w/ Double Bottom Mount AMR Brackets Cover - Reclaimed Water	Black	96	15.00	20ME
D15-BAMRLP-AM	13" x 20" x 12" Drop in Solid Plastic Cover - Reclaimed Water	Purple	96	15.00	20ME
D15-BAMRP	13" x 20" x 12" Drop in Solid Plastic Cover with Lid - Reclaimed Water	Purple/Purple	48	15.00	20ME
Box Only					
D1500-B/O	13" x 20" x 12" Jumbo Box	Black	48	9.40	20ME
D1500-DUB/O	13" x 20" x 12" Dual Pipe Slot Box	Black	48	8.91	20ME
D750E-EXT	13" x 20" x 6" Extension	Black	36	5.60	20ME

NDS METER BOXES – STANDARD COMMERCIAL GRADE

NDS D109 Meter Boxes

Specifications: NDS 6" round meter boxes and covers are injection molded of recycled polyolefin material with a melt index between 10-12. Coloring and UV stabilizers are added, along with processing lubricants when needed. The 6" round body is tapered and has a minimum wall thickness of 0.13". The body has a double wall at the top cover seat area with a minimum thickness of 0.125". The bottom of the body has a 0.250" flange. The 6" round cover has an average thickness of 0.15".

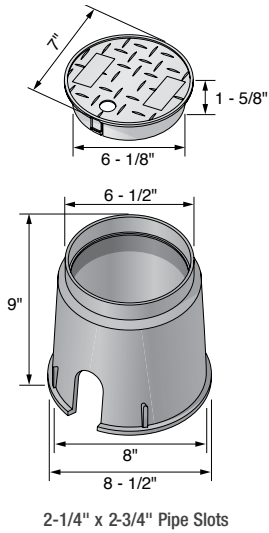

Part No.	Description - Marking	Color (Box/Cover)	Pallet Qty.	Wt. Ea. lbs.	Product Class
Box & Cover					
D109-B	6" Round Box, Overlapping Solid Plastic Cover - Water Meter	Black/Black	900	1.21	20ME
D109-P	6" Round Box, Overlapping Solid Plastic Cover - Reclaimed Water	Purple/Purple	900	1.21	20ME
Cover Only					
D109-PL	6" Round Overlapping Solid Plastic Cover - Reclaimed Water	Purple	900	0.40	20ME
D1100-SPL	10" Overlapping Cover - Reclaimed	Purple	350	0.80	20ME
Box Only					
D109-B/O	6" Round Box	Black	600	0.80	20ME

NDS D1000 Meter Boxes

Specifications: NDS D1000 meter boxes and covers are injection molded of structural foam recycled polyolefin material with a melt index between 10-12. Coloring and UV stabilizers are added, along with processing lubricants when needed. NDS 10" x 15" x 10" body is tapered and has a minimum wall thickness of 0.13". The body has a double wall at the top cover seat area with a minimum thickness of 0.20". The cover seat area has 12 structural support ribs on the underside of the seat, each with a minimum thickness of 0.13". The bottom of the body has a 0.75" flange.

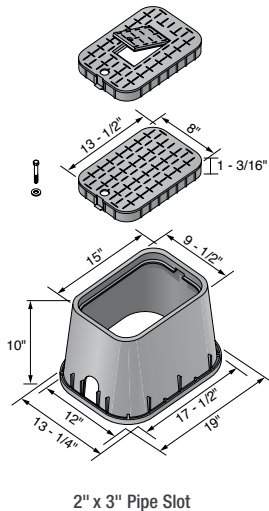

Part No.	Description - Marking	Color (Box/Cover)	Pallet Qty.	Wt. Ea. lbs.	Product Class
Drop-in Box & Cover					
D1000-SB	10" x 15" x 10" Box, Drop-in Solid Plastic Cover - Water Meter	Black/Black	96	5	20ME
D1000-RB	10" x 15" x 10" Box, Drop-in Meter Reader Plastic w/ Plastic Reader Cover - Water Meter	Black/Black	96	5	20ME
Drop-in Cover Only					
D1000-SBL	10" x 15" Drop-in Meter Solid Plastic Cover - Water Meter	Black	300	1.4	20ME
D1000-RBL	10" x 15" Drop-in Meter Reader w/ Plastic Reader Cover - Water Meter	Black	300	1.6	20ME

NDS METER BOXES – STANDARD COMMERCIAL GRADE

NDS D1200 Meter Boxes

Specifications: NDS D1200 meter boxes and covers are injection molded of structural foam recycled polyolefin material with a melt index between 10-12. Coloring and UV stabilizers are added, along with processing lubricants when needed. NDS 14" x 19" x 12" body is tapered and has a minimum wall thickness of 0.25". The body has a double wall at the top cover seat area with a minimum thickness of 0.187". The cover seat area has 30 structural support ribs on the underside of the seat, each with a minimum thickness of 3/16". The bottom of the body has a 1" flange. The D1200 cover has a minimum thickness of 0.250".

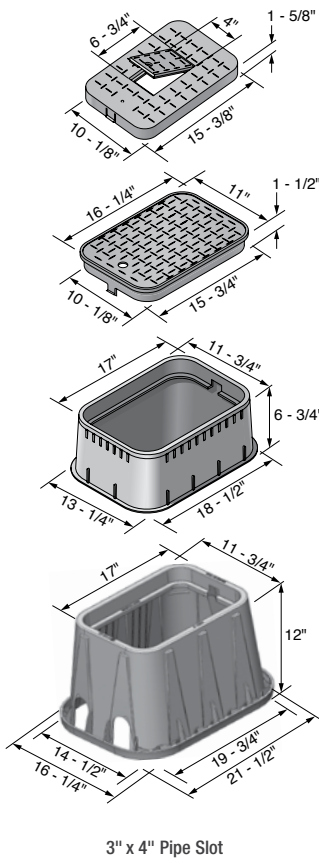

Part No.	Description - Marking	Color (Box/Cover)	Pallet Qty.	Wt. Ea. lbs.	Product Class
Drop-in Box & Cover					
D1200-DISB	14" x 19" x 12" Standard Box, Drop-in Solid Plastic Cover - Water Meter	Black/Black	72	9.00	20ME
D1200-DUDISB	14" x 19" x 12" Standard Dual Pipe Slot Box, Drop-in Solid Plastic Cover - Water Meter	Black/Black	72	9.00	20ME
D1200-DISBSWR	14" x 19" x 12" Standard Box, Drop-in Solid Plastic Cover - Sewer	Black/Black	72	9.00	20ME
D1200-DISGSWR	14" x 19" x 12" Standard Box, Drop-in Solid Plastic Cover - Sewer	Black/Green	72	9.00	20ME
D1200-DISBLU	14" x 19" x 12" Standard Box, Drop-in Solid Plastic Cover - Water Meter	Black/Blue	72	9.00	20ME
D1200-DIRB	14" x 19" x 12" Standard Box, Drop-in Meter Reader Plastic w/ Plastic Reader Cover - Water Meter	Black/Black	72	9.00	20ME
D1200-DUDIRB	14" x 19" x 12" Standard Dual Pipe Slot Box, Drop-in Meter Reader Plastic w/ Plastic Reader Cover - Water Meter	Black/Black	72	9.00	20ME
D1200-DIBLRD	14" x 19" x 12" Standard Box, Drop-in Meter Reader Plastic w/ Plastic Reader Cover - Water Meter	Black/Blue	72	9.00	20ME
D1200-DIRG	14" x 19" x 12" Standard Box, Drop-in Meter Reader Plastic w/ Plastic Reader Cover - Water Meter	Black/Green	72	9.00	20ME
D1200-DICIR	14" x 19" x 12" Standard Box, Drop-in Meter Reader Plastic w/ Cast Iron Reader Cover - Water Meter	Black/Black	72	10.20	20ME
D1200-DUDICIR	14" x 19" x 12" Standard Dual Pipe Slot Box, Drop-in Meter Reader Plastic w/ Cast Iron Reader Cover - Water Meter	Black/Black	72	10.20	20ME
D1200P-DICIRP	14" x 19" x 12" Standard Box, Drop-in Meter Reader Plastic w/ Cast Iron Reader Cover - Reclaimed Water	Purple/Purple	72	10.20	20ME
Cover Only					
D1200-DISBLUL	12" Drop in Solid Plastic Cover - Meter Reader	Blue	216	2.20	20ME

NDS METER BOXES – STANDARD COMMERCIAL GRADE

NDS D1200 Meter Boxes (continued)

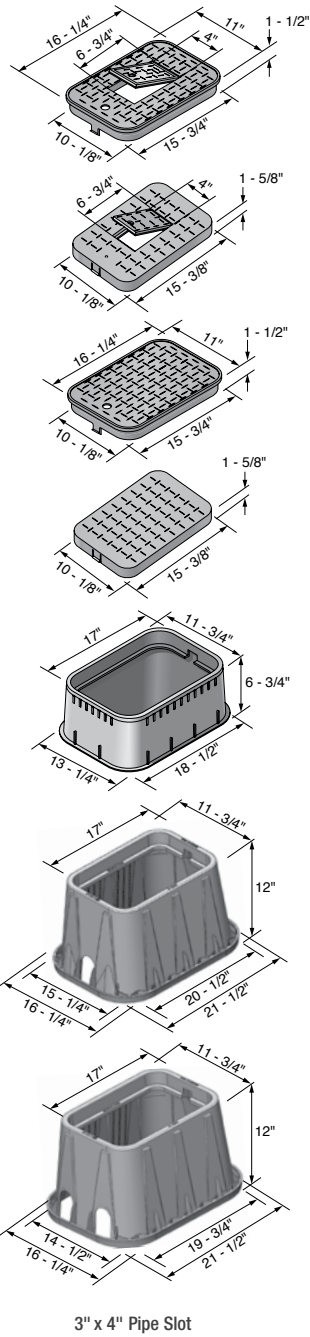

Part No.	Description - Marking	Color (Box/Cover)	Pallet Qty.	Wt. Ea. lbs.	Product Class
Overlapping Box & Cover					
D1200-OLSB	14" x 19" x 12" Standard Box, Overlapping Solid Plastic Cover – Water Meter	Black/Black	72	9.20	20ME
D1200-DUOLSB	14" x 19" x 12" Standard Dual Pipe Slot Box, Overlapping Solid Plastic Cover – Water Meter	Black/Black	72	9.20	20ME
D1200-OLLOCB	14" x 19" x 12" Standard Box, Overlapping Locking Solid Plastic Cover – Water Meter	Black/Black	72	9.40	20ME
D1200-CI	14" x 19" x 12" Standard Box, Overlapping Solid Cast Iron Cover – Water Meter	Black/Black	72	19.00	20ME
D1200-OLRB	14" x 19" x 12" Standard Box, Overlapping Meter Reader Plastic with Plastic Reader Cover – Water Meter	Black/Black	72	9.20	20ME
D1200-OLCIR	14" x 19" x 12" Standard Box, Overlapping Meter Reader Plastic with Cast Iron Reader Cover – Water Meter	Black/Black	72	10.60	20ME
D1200-OLRBLU	12" Overlapping Cover with Plastic Meter Reader	Black/Blue	72	9.20	20ME
D1200-CICIR	14" x 19" x 12" Standard Box, Overlapping Meter Reader Cast Iron w/ Cast Iron Reader Cover – Water Meter	Black/Black	72	10.28	20ME
Drop-in Cover Only					
D1200-DISBL	14" x 19" Drop-in Solid Plastic Cover – Water Meter	Black	216	2.20	20ME
D1200-DISBSWRL	14" x 19" Drop-in Solid Plastic Cover – Sewer	Black	216	2.20	20ME
D1200-DISGL	12" Drop in Solid Plastic Cover – Meter Reader	Green	216	2.20	20ME
D1200-DISGSWRL	14" x 19" Drop-in Solid Plastic Cover – Sewer	Green	216	2.20	20ME
D1200-DIRBL	14" x 19" Drop-in Meter Reader with Plastic Reader Cover – Water Meter	Black	216	2.20	20ME
D1200-DIBLRDL	14" x 19" Drop-in Meter Reader with Plastic Reader Cover – Water Meter	Blue	216	2.20	20ME
D1200-DICIRLID	14" x 19" Drop-in Meter Reader with Cast Iron Reader Cover – Water Meter	Black	216	3.40	20ME
Overlapping Cover Only					
D1200-CICIR LD	14" x 19" Overlapping Cast Iron Lid with Cast Iron Reader – Water Meter	Black	216	2.40	20ME
D1200-OLSBL	14" x 19" Overlapping Solid Plastic Cover – Water Meter	Black	216	2.40	20ME
D1200-OLSGL	12" Overlapping Cover with Solid Plastic Meter Reader	Green	216	2.40	20ME
D1200-OLLOCBLD	14" x 19" Overlapping Locking Solid Plastic Cover – Water Meter	Black	100	2.60	20ME
D1200-OLBLL	14" x 19" Overlapping Solid Plastic Cover – Water Meter	Blue	216	2.40	20ME
D1200-CIL	14" x 19" Overlapping Meter Reader Solid Cast Iron Cover – Water Meter	Black	216	12.20	20ME
D1200-OLRBLUL	14" x 19" Overlapping Meter Reader Plastic with Plastic Reader Cover – Water Meter	Blue	216	2.40	20ME
D1200-OLCIR LD	14" x 19" Overlapping Meter Reader Plastic with Cast Iron Reader Cover – Water Meter	Black	216	3.80	20ME
D1200-OLCIRSS	12" Overlapping Cover with Cast Iron Meter Reader	Black/Black	72	10.33	20ME
Box Only					
D1200-B/O	14" x 19" x 12" Standard Box	Black	72	6.80	20ME
D1200-DUB/O	14" x 19" x 12" Standard Dual Pipe Slot Box	Black	72	6.80	20ME
D1200G-B/O	14" x 19" x 12" Standard Box	Green	72	6.80	20ME
D600E-EXT	14" x 19" x 6" Extension Only	Black	42	4.20	20ME

NDS METER BOXES – STANDARD COMMERCIAL GRADE

NDS D1500 Meter Boxes

Specifications: NDS 13" x 20" meter boxes and covers are injection molded of structural foam recycled polyolefin material with a melt index between 10-12. Coloring and UV stabilizers are added, along with processing lubricants when needed. The 13" x 20" body is tapered and has a minimum wall thickness of 0.250". The body has a double wall at the top cover seat area with a minimum thickness of 0.187". The cover seat area has 30 structural support ribs on the underside of the seat, each with a minimum thickness of 1/50". The bottom of the body has a 1" flange. The 13" x 20" cover has an average thickness of 0.250".

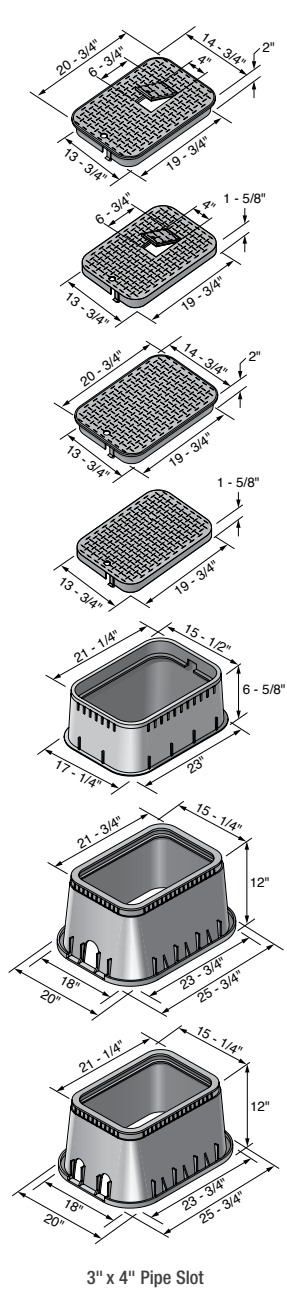

3" x 4" Pipe Slot

Part No.	Description - Marking	Color (Box/Cover)	Pallet Qty.	Wt. Ea. lbs.	Product Class
Drop-in Box & Cover					
D1500-DISB	13" x 20" x 12" Jumbo Box, Drop-in Solid Plastic Cover – Water Meter	Black/Black	48	13.20	20ME
D1500-DUDISB	13" x 20" x 12" Dual Pipe Slot Jumbo Box, Drop-in Solid Plastic Cover – Water Meter	Black/Black	48	13.49	20ME
D1500-DIRB	13" x 20" x 12" Jumbo Box, Drop-in Meter Reader Plastic w/ Plastic Reader Cover – Water Meter	Black/Black	48	13.20	20ME
D1500-DUDIRB	13" x 20" x 12" Dual Pipe Slot Jumbo Box, Drop-in Meter Reader Plastic with Plastic Reader Cover – Water Meter	Black/Black	48	13.49	20ME
D1500-DICIR	13" x 20" x 12" Jumbo Box, Drop-in Meter Reader Plastic w/ Cast Iron Reader Cover – Water Meter	Black/Black	48	14.40	20ME
D1500-DUDICIR	13" x 20" x 12" Dual Pipe Slot Jumbo Box, Drop-in Meter Reader Plastic with Cast Iron Reader Cover – Water Meter	Black/Black	48	13.20	20ME
D1500P-DU-DICP	13" x 20" x 12" Dual Pipe Slot Jumbo Box, Drop-in Meter Reader Plastic with Cast Iron Reader Cover – Water Meter	Purple/Purple	48	14.60	20ME
D1500-DIRBLU	13" x 20" Drop-in Plastic Cover with Plastic Meter Reader – Water Meter	Blue/Blue	48	11.60	20ME
Overlapping Box & Cover					
D1500-OLSB	13" x 20" x 12" Jumbo Box, Overlapping Solid Plastic Cover – Water Meter	Black/Black	48	13.20	20ME
D1500-OLRB	13" x 20" x 12" Jumbo Box, Overlapping Meter Reader Plastic w/ Plastic Reader Cover – Water Meter	Black/Black	48	13.20	20ME
Drop-in Cover Only					
D1500-DISBL	13" x 20" Drop-in Solid Plastic Cover – Water Meter	Black	96	3.80	20ME
D1500-DIRBL	13" x 20" Drop-in Meter Reader Plastic with Plastic Reader Cover – Water Meter	Black	96	3.80	20ME
D1500-DICIR LD	13" x 20" Drop-in Meter Reader Plastic with Cast Iron Reader Cover – Water Meter	Black	96	5.00	20ME
Overlapping Cover Only					
D1500-OLSBL	13" x 20" Jumbo Overlapping Solid Plastic Cover – Water Meter	Black	96	3.80	20ME
D1500-OLRBL	13" x 20" Overlapping Plastic Cover with Plastic Meter Reader – Water Meter	Black	96	3.80	20ME
D1500-OLSGL	13" x 20" Overlapping Plastic Cover with Plastic Meter Reader – Water Meter	Green	96	3.80	20ME
Box Only					
D1500-B/O	13" x 20" x 12" Jumbo Box	Black	48	9.40	20ME
D1500-DUB/O	13" x 20" x 12" Dual Pipe Slot Jumbo Box	Black	48	8.91	20ME
D750E-EXT	13" x 20" x 6" Extension Only	Black	36	5.60	20ME
D1500-DICIRBLU	13" x 20" Drop-in Meter Reader Cover, Blue Plastic with Cast Iron Reader Cover – Water Meter	Blue	96	5.00	20ME

NDS METER BOXES – STANDARD COMMERCIAL GRADE

NDS D1800 Meter Boxes

Specifications: NDS 14" x 19" x 18" meter boxes and covers are injection molded of structural foam recycled polyolefin material with a melt index between 10-12. Coloring and UV stabilizers are added, along with processing lubricants when needed. The 14" x 19" body is tapered and has a minimum wall thickness of 0.250". The body has a double wall at the top cover seat area with a minimum thickness of 0.22". The cover seat area has 26 structural support ribs on the underside of the seat, each with a minimum thickness of 0.12". The bottom of the body has a 0.50" flange. The 14" x 19" cover has an average thickness of 0.20".

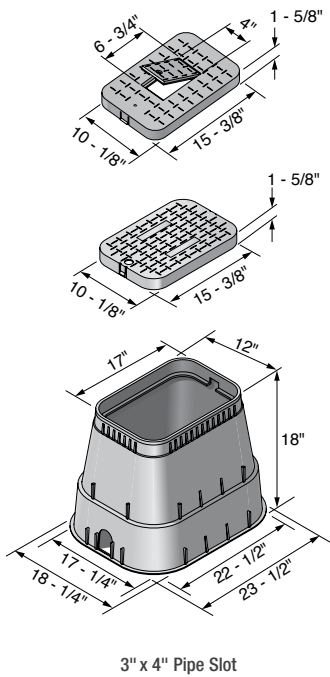

Part No.	Description - Marking	Color (Box/Cover)	Pallet Qty.	Wt. Ea. lbs.	Product Class
Drop-in Box & Cover					
D1800-DISB	14" x 19" x 18" Box, Drop-in Solid Plastic Cover - Water Meter	Black/Black	48	12.20	20ME
D1800-DIRB	14" x 19" x 18" Box, Drop-in Meter Reader Plastic w/ Plastic Reader Cover - Water Meter	Black/Black	48	12.20	20ME
D1800-DICIR	14" x 19" x 18" Box, Drop-in Meter Reader Plastic w/ Cast Iron Reader Cover - Water Meter	Black/Black	48	13.40	20ME
Drop-in Cover Only					
D1200-DISBL	14" x 19" Drop-in Box Solid Plastic Cover - Water Meter	Black	216	2.20	20ME
D1200-DIRBL	14" x 19" Drop-in Meter Reader w/ Plastic Reader Cover - Water Meter	Black	216	2.20	20ME
D1200-DICIRLID	14" x 19" Drop-in Meter Reader w/ Cast Iron Reader Cover - Water Meter	Black	216	3.40	20ME
D1200-DISBSWRL	14" x 19" Drop-in Solid Plastic Cover - Sewer	Black	216	2.20	20ME
Overlapping Cover Only					
D1800-OLSG	14" x 19" Overlapping Cover - ICV	Black/Green	48	12.40	20ME
Box Only					
D1800-B/O	14" x 19" x 18" Box	Black	48	10.00	20ME
D1800-B/O NH	14" x 19" x 18" Box, No Pipe Slots	Black	48	10.00	20ME
D1800-B/O WHT	14" x 19" Box	White	48	10.00	20ME

NDS METER BOXES – STANDARD COMMERCIAL GRADE

NDS D2400 Meter Boxes

Specifications: NDS 16" round meter pits and covers are injection molded of structural foam recycled polyolefin material with a melt index between 10-12. Coloring and UV stabilizers are added, along with processing lubricants when needed. The 16" round meter pit body is tapered and has a minimum wall thickness of 0.2615". The body has a double wall at the top cover seat area with a minimum thickness of 0.2780". The cover seat area has 8 structural support ribs on the underside of the seat, each with a minimum thickness of 0.0995". The bottom of the body has a 1/2" flange which flares to 1-1/4" at bolt hole. The 12-3/8" cover has an average thickness of 0.375".

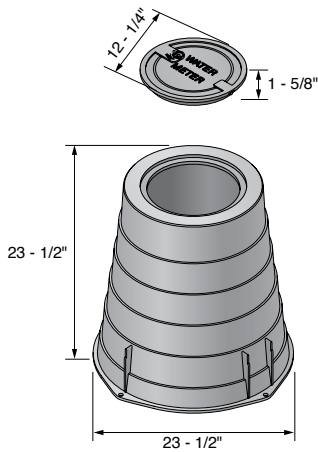

Part No.	Description - Marking	Color (Box/Cover)	Pallet Qty.	Wt. Ea. lbs.	Product Class
Box & Cover					
D2400-18LOCSB	18" Meter Pit, Overlapping Locking Solid Plastic Cover - Water Meter	Black/Black	52	11.40	20ME
D2400-LOCSB	24" Meter Pit, Overlapping Locking Solid Plastic Cover - Water Meter	Black/Black	52	17.53	20ME
Cover Only					
D2400-LOCSWBL	Overlapping Locking Solid Plastic Cover - Water Meter	Black	52	1.60	20ME
Box Only					
D2400-18 B/O	18" Meter Pit	Black	52	9.80	20ME
D2400-B/O	24" Meter Box	Black	52	14.00	20ME

NDS Replacement Parts

Part No.	Description - Marking	Color (Box/Cover)	Pallet Qty.	Wt. Ea. lbs.	Product Class
DKEY	Brass Locking Key	Brass	1	0.50	20ME

NDS PRO SERIES METER BOXES – PREMIUM COMMERCIAL GRADE

NDS 6" Round Meter Boxes

Specifications: The NDS 6" round meter boxes and covers are injection molded of structural foam polyolefin material with a melt index between 10-12. Coloring and UV stabilizers are added, along with processing lubricants when needed. The 6" round body is tapered and has a minimum wall thickness of 0.20". The body has a double wall at the top cover seat area with a minimum thickness of 0.13". The bottom of the body has a 0.250" flange. The 6" round cover has an average thickness of 0.187".

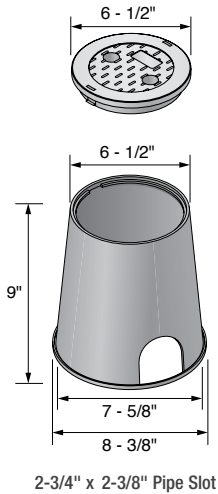

Part No.	Description - Marking	Color (Box/Cover)	Pallet Qty.	Wt. Ea. lbs.	Product Class
Box & Cover					
107BCW	6" Round Box, Overlapping Solid Plastic Cover - Water Meter	Black/Green	250	1.50	20NM
107BCR	6" Round Box, Overlapping Solid Plastic Cover - Reclaimed Water	Black/Purple	250	1.50	20ND
107PBCR	6" Round Box, Overlapping Solid Plastic Cover - Reclaimed Water	Purple/Purple	250	1.50	20ND
107BCS	6" Round Box, Overlapping Solid Plastic Cover - Sewer	Black/Green	250	1.50	20NM
208BCS	6" Round Box, Round Overlapping Solid Plastic Cover - Sewer	Green/Green	250	1.50	20PR
Cover Only					
107CW	6" Overlapping Solid Plastic Cover - Water Meter	Green	800	0.40	20NM
107CR	6" Overlapping Solid Plastic Cover - Reclaimed Water	Purple	800	0.40	20ND
107CS	6" Overlapping Solid Plastic Cover - Sewer	Green	800	0.40	20NM
Box Only					
107B	6" Round Box	Black	250	1.23	20ND

NDS 10" Round Meter Boxes

Specifications: The NDS 10" round meter boxes and covers are injection molded of structural foam polyolefin material with a melt index between 10-12. Coloring and UV stabilizers are added, along with processing lubricants when needed. The 10" round body is tapered and has a minimum wall thickness of 0.30". The cover seat area has 8 structural support ribs on the underside of the seat, each with a minimum thickness of 0.250". The bottom of the body has a 0.50" flange. The 10" round cover has an average thickness of 0.30". The meter box has a 3/8" 304 Brass nut for the bolt-down as a standard feature.

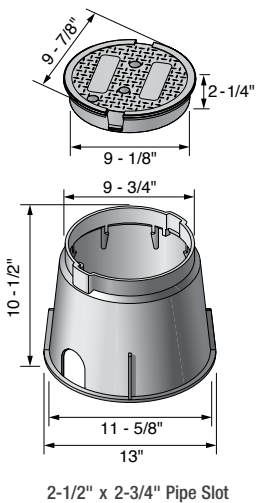

Part No.	Description - Marking	Color (Box/Cover)	Pallet Qty.	Wt. Ea. lbs.	Product Class
Box & Cover					
211PBCR	10" Round Box, Overlapping Reclaimed Solid Plastic Cover - Water Meter	Purple/Purple	120	4.50	20PR
111BCS	10" Round Box, Overlapping Solid Plastic Cover - Sewer	Black/Green	180	3.00	20NM
212BCS	10" Round Box, Round Overlapping Solid Plastic Cover - Sewer	Green/Green	120	4.50	20PR
212BCBS	10" Round Box, Round Overlapping Bolt-Down Solid Plastic Cover - Sewer	Green/Green	120	4.50	20PR
212BC ELEC	10" Round Box, Overlapping Solid Plastic Cover - Electrical	Gray/Gray	120	4.50	20PR
212BCB ELEC	10" Round Box, Overlapping Bolt-Down Solid Plastic Cover - Electrical**	Gray/Gray	120	4.50	20PR
Cover Only					
211CW	10" Overlapping Water Solid Plastic Cover - Water Meter	Black	200	1.34	20PR
211CR	10" Overlapping Reclaimed Solid Plastic Cover - Water Meter	Purple	200	1.50	20PR
111CS	10" Round Overlapping Solid Plastic Cover - Sewer	Green	300	1.00	20NM
211CRG	10" Round Overlapping Solid Plastic Cover - Reclaimed Water	Green	200	1.34	20PR
211CS	10" Round Overlapping Solid Plastic Cover - Sewer	Green	200	1.50	20PR
211C ELEC	10" Overlapping Solid Plastic Cover - Electrical	Gray	200	1.50	20PR
Box Only					
212B	10" Round Box	Green	120	3.00	20PR
211BB	Bolt for 10" Cover	Steel	(Bag of 10)	0.05	20PR

**Note – Installer responsible for ensuring product meets local building/electrical code requirements.

NDS PRO SERIES METER BOXES – PREMIUM COMMERCIAL GRADE

NDS 14" x 19" Meter Boxes

Specifications: The NDS 14" x 19" meter boxes and covers are injection molded of structural foam polyolefin material with a melt index between 10-12. Coloring and UV stabilizers are added, along with processing lubricants when needed. The 14" x 19" body is tapered and has a minimum wall thickness of 0.250". The body has a double wall at the top cover seat area with a minimum thickness of 0.250". The cover seat area has 16 structural support ribs on the underside of the seat, each with a minimum thickness of 0.250". The bottom of the body has a 0.50" flange. The 12" x 20" cover shall have an average thickness of 0.250". The meter box has a 3/8" 304 Brass nut for the bolt-down as a standard feature.

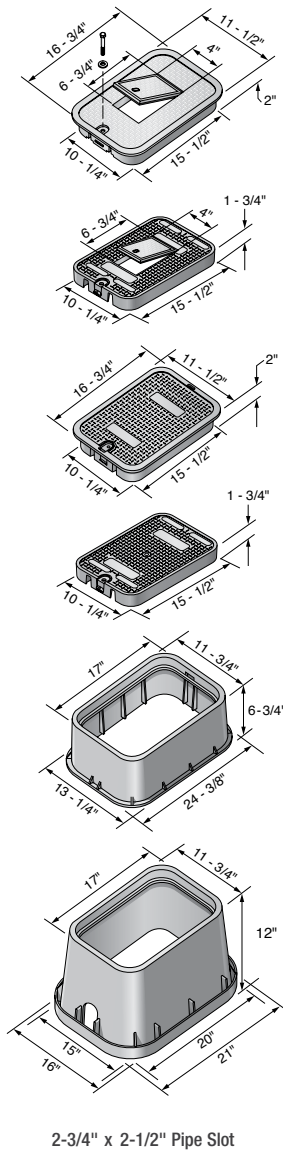

Part No.	Description - Marking	Color (Box/Cover)	Pallet Qty.	Wt. Ea. lbs.	Product Class
Drop-in Box & Cover					
113BCDW	14" x 19" x 12" Box, Drop-in Solid Plastic Cover - Water Meter	Black/Black	78	8.00	20NM
113BCDS	14" x 19" x 12" Box, Drop-in Solid Plastic Cover - Sewer	Black/Green	78	8.00	20NM
113BCDMCIF	14" x 19" x 12" Box, Drop-in Meter Reader Plastic w/ Cast Iron Reader Cover - Water Meter	Black/Black	78	12.00	20NM
Overlapping Box & Cover					
113BCW	14" x 19" x 12" Box, Overlapping Solid Plastic Cover - Water Meter	Black/Black	78	9.32	20NM
113BCS	14" x 19" x 12" Box, Overlapping Solid Plastic Cover - Sewer	Black/Green	78	9.32	20NM
113BCE	14" x 19" x 12" Box, Overlapping Solid Plastic Cover - Electrical	Green/Green	78	9.32	20NM
113BCR	14" x 19" x 12" Box, Overlapping Solid Plastic Cover - Reclaimed Water	Black/Purple	78	9.10	20ND
113PBCR	14" x 19" x 12" Box, Overlapping Solid Plastic Cover - Reclaimed Water	Purple/Purple	78	9.29	20ND
113BCM	14" x 19" x 12" Box, Overlapping Meter Reader Plastic w/ Plastic Reader Cover - Water Meter	Black/Black	78	8.92	20NM
113BCMCIF	14" x 19" x 12" Box, Overlapping Meter Reader Plastic w/ Cast Iron Reader Cover - Water Meter	Black/Black	78	9.38	20NM
213PBCR	14" x 19" Box, Overlapping Solid Plastic Cover - Reclaimed Water	Purple/Purple	78	9.00	20PR
214BCS	14" x 19" Box, Overlapping Solid Plastic Cover - Sewer	Green/Green	78	9.00	20PR
214BCB ELEC	14" x 19" Box, Overlapping Bolt-Down Solid Plastic Cover - Electrical**	Gray/Gray	78	9.00	20PR
Drop-in Cover Only					
113CDMCIF	14" x 19" Drop-in Meter Reader Plastic w/ Cast Iron Reader Cover - Water Meter	Black	300	3.80	20NM
Overlapping Cover Only					
113CW	14" x 19" Overlapping Solid Plastic Cover - Water Meter	Black	300	2.30	20NM
114CW	14" x 19" Overlapping Solid Plastic Cover - Water Meter	Green	300	2.30	20NM
113CR	14" x 19" Overlapping Solid Plastic Cover - Reclaimed Water	Purple	300	2.50	20ND
113CE	14" x 19" Overlapping Solid Plastic Cover - Electric	Green	300	2.30	20NM
113CM	14" x 19" Overlapping Meter Reader Plastic w/ Plastic Reader Cover - Water Meter	Black	300	2.50	20NM
113CMCIF	14" x 19" Overlapping Meter Reader Plastic w/ Cast Iron Reader Cover - Water Meter	Black	300	3.65	20NM
213CS	14" x 19" Overlapping Solid Plastic Cover - Sewer	Green	300	2.50	20PR
213C ELEC	14" x 19" Overlapping Solid Plastic Cover - Electrical**	Gray	300	2.50	20PR
Box Only					
113B	14" x 19" x 12" Box	Black	78	6.00	20NM
113-6	14" x 19" x 6" Extension	Black	49	4.00	20ND
114-6	14" x 19" x 6" Extension	Green	49	3.86	20ND
113BB	2-1/2" x 3/8" SS Bolt	Steel	(Bag of 10)	0.10	20NM

**Note – Installer responsible for ensuring product meets local building/electrical code requirements.

NDS PRO SERIES METER BOXES – PREMIUM COMMERCIAL GRADE

NDS 13" x 20" Meter Boxes

Specifications: The NDS 13" x 20" meter boxes and covers are injection molded of structural foam polyolefin material with a melt index between 10-12. Coloring and UV stabilizers are added, along with processing lubricants when needed. The 13" x 20" body is tapered and has a minimum wall thickness of 0.250". The body has a double wall at the top cover seat area with a minimum thickness of 0.250". The cover seat area has 16 structural support ribs on the underside of the seat, each with a minimum thickness of 0.250". The bottom of the body has a 0.50" flange. The 13" x 20" cover has an average thickness of 0.250". The meter box has a 3/8" 304 Brass nut for the bolt-down as a standard feature.

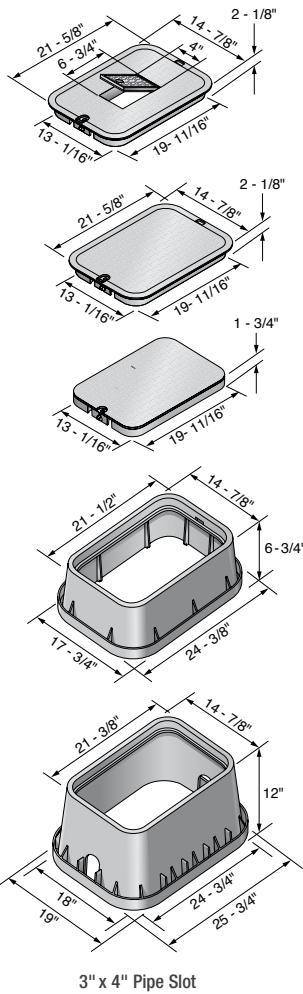

Part No.	Description - Marking	Color (Box/Cover)	Pallet Qty.	Wt. Ea. lbs.	Product Class
Drop-in Box & Cover					
117BCDW	13" x 20" x 12" Box, Drop-in Solid Plastic Cover - Water	Black/Black	56	13.25	20NM
Overlapping Box & Cover					
117BCS	13" x 20" x 12" Box, Overlapping Solid Plastic Cover - Sewer	Black/Green	56	14.00	20NM
117B12CW	13" x 20" x 12" Valve Box with Overlapping Cover - Water	Black	56	14.00	20NM
217PBCR	13" x 20" Jumbo Box, Overlapping Solid Plastic Cover - Reclaimed Water	Purple	56	13.69	20PR
218BCS	13" x 20" Jumbo Box, Overlapping Solid Plastic Cover - Sewer	Green/Green	56	14.00	20PR
Drop-in Cover Only					
117CDMCF	13" x 20" Drop-in Meter Reader Plastic w/ Cast Iron Reader Cover - Water Meter	Black	180	7.50	20NM
Overlapping Cover Only					
117CW	13" x 20" Overlapping Solid Plastic Cover - Water Meter	Black	180	5.00	20NM
117CS	13" x 20" Overlapping Solid Plastic Cover - Sewer	Green	180	5.00	20NM
217CR	13" x 20" Jumbo Overlapping Solid Plastic Cover - Reclaimed Water	Purple	180	4.51	20PR
Box Only					
117B	13" x 20" x 12" Box, Single Inlet, Single Outlet	Black	56	8.14	20NM
117-6	13" x 20" Jumbo Extension	Black	32	6.88	20ND
113BB	2-1/2" x 3/8" SS Bolt	Steel	(Bag of 10)	0.10	20NM

NDS PRO SERIES METER BOXES – PREMIUM COMMERCIAL GRADE

NDS 13" x 24" Meter Boxes

Specifications: The NDS 13" x 24" meter boxes and covers are injection molded of structural foam polyolefin material with a melt index between 10-12. Coloring and UV stabilizers are added, along with processing lubricants when needed. The 13" x 24" body is tapered and has a minimum wall thickness of 0.27". The body has a double wall at the top cover seat area with a minimum thickness of 0.27". The cover seat area has 18 structural support ribs on the underside of the seat, each with a minimum thickness of 0.250". The bottom of the body has a 1" flange. The 13" x 24" cover has an average thickness of 0.32". The meter box has a 3/8" 304 Brass nut for the bolt-down as a standard feature.

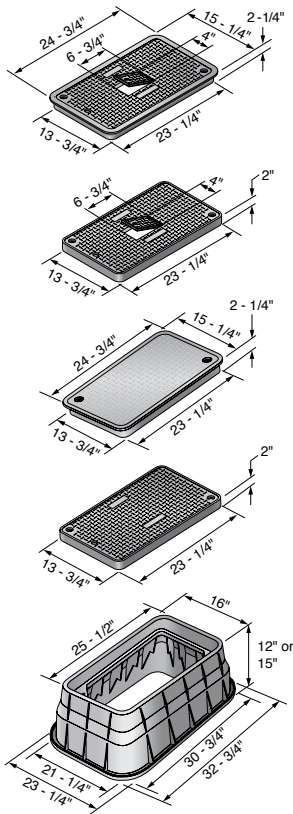

Part No.	Description - Marking	Color (Box/Cover)	Pallet Qty.	Wt. Ea. lbs.	Product Class
Drop-in Box & Cover					
121BCDWB	13" x 24" x 12" Box, Bolt-Down Drop-in Solid Plastic Cover - Water Meter	Black/Black	12	22.78	20NM
121BCDMCIFB	13" x 24" x 12" Box, Bolt-Down Drop-in Meter Reader Plastic w/ Cast Iron Reader Cover - Water Meter	Black/Black	12	23.13	20NM
125BCDMCIFB	13" x 24" x 15" Box, Bolt-Down Drop-in Meter Reader Plastic w/ Cast Iron Reader Cover - Water Meter	Black/Black	12	26.13	20NM
**Note – Installer responsible for ensuring product meets local building/electrical code requirements. Insulate bolt with 1/2" x 2-3/4" heat shrink tube and/or a ground rod clamp (such as Thomas & Betts Part Number 63) to reduce the chance of electrical shock.					
Overlapping Box & Cover					
125PBCRB	13" x 24" x 15" Box, Bolt-Down Overlapping Solid Plastic Cover - Reclaimed Water	Purple/Purple	12	26.44	20ND
Drop-in Cover Only					
121CDMCI	13" x 24" Drop-in Meter Reader Plastic w/ Cast Iron Reader Cover - Water Meter	Black	125	7.13	20NM
Box Only					
125B	13" x 24" x 15" Box	Black	12	19.00	20NM

**Note – Installer responsible for ensuring product meets local building/electrical code requirements.

NDS PRO SERIES METER BOXES – PREMIUM COMMERCIAL GRADE

NDS 17" x 30" Meter Boxes

Specifications: The NDS 17" x 30" meter boxes and covers are injection molded of structural foam polyolefin material with a melt index between 10-12. Coloring and UV stabilizers are added, along with processing lubricants when needed. The 17" x 30" body is tapered and has a minimum wall thickness of 0.32". The body has a double wall at the top cover seat area with a minimum thickness of 0.32". The cover seat area has 20 structural support ribs on the underside of the seat, each with a minimum thickness of 0.250". The bottom of the body has a 1" flange. The 17" x 30" cover has an average thickness of 0.35". The meter box has a 3/8" 304 SS Brass for the bolt-down as a standard feature.

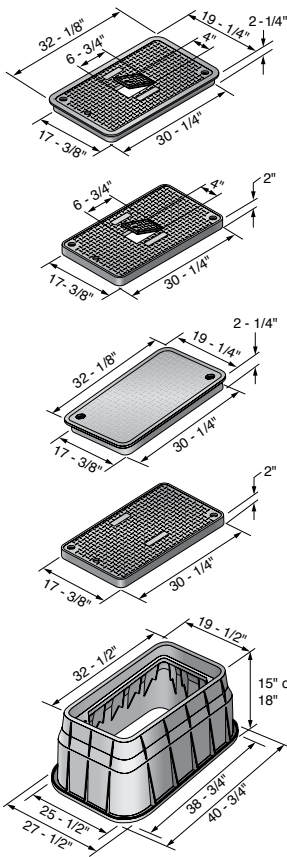

METER BOXES

Part No.	Description - Marking	Color (Box/Cover)	Pallet Qty.	Wt. Ea. lbs.	Product Class
Drop-in Box & Cover					
124BCDWB	17" x 30" x 15" Box, Bolt-Down Drop-in Solid Plastic Cover - Water Meter	Black/Black	12	34.70	20NM
126BCDWB	17" x 30" x 18" Box, Bolt-Down Drop-in Solid Plastic Cover - Water Meter	Black/Black	10	37.65	20NM
126BCDMB	17" x 30" x 18" Box, Bolt-Down Drop-in Plastic w/ Plastic Reader Cover - Water Meter	Black/Black	10	41.00	20NM
124BCDMCIFB	17" x 30" x 15" Box, Bolt-Down Drop-in Plastic w/ Cast Iron Reader Cover - Water Meter	Black/Black	12	33.70	20NM
126BCDMCIFB	17" x 30" x 18" Box, Bolt-Down Drop-in Plastic w/ Cast Iron Reader Cover - Water Meter	Black/Black	10	37.65	20NM
226BCDB ELEC	17" x 30" x 18" Box, Bolt-Down Drop-in Solid Plastic Cover - Electric**	Gray/Gray	10	37.05	20PR
Overlapping Cover Only					
223CR	17" x 30" Overlapping Solid Plastic Cover - Reclaimed Water	Purple	75	11.60	20ND
Drop-in Cover Only					
123CDMCF	17" x 30" Drop In Cover with Cast Iron Meter Reader	Black	75	10.30	20NM
123CDW	17" x 30" Drop in Cover - Water	Black	75	1.50	20NM
Box Only					
124B	17" x 30" x 15" Box	Black	12	20.00	20NM
126B	17" x 30" x 18" Box	Black	10	23.80	20NM

**Note – Installer responsible for ensuring product meets local building/electrical code requirements.

METER BOXES PRODUCT INDEX

Part No.	Page	Part No.	Page	Part No.	Page	Part No.	Page	Part No.	Page
107B	214	117CS	216	218BCS	216	D1200-CICIR LD	210	D1200-OLSBL	206, 210
107BCR	214	117CW	216	223CR	218	D1200-CIL	210	D1200-OLSGL	210
107BCS	214	121BCDMCIFB	217	226BCDB ELEC	218	D1200-DIBLRD	209	D1200-OLTR	205
107BCW	214	121BCDWB	217	D12AMR-OLLOCL	205	D1200-DIBLRDL	210	D1200P-DICIRP	209
107CR	214	121CDMCIF	217	D12AMR-OLLOCTRL	205	D1200-DICIR	209	D1500-B/O	207, 211
107CS	214	123CDMCIF	218	D12AMR-OLLOCTRL	205	D1200-DICIRBLU	206	D1500-DICIR	211
107CW	214	123CDW	218	D12-BAMR	205	D1200-DICIRLID	206, 210, 212	D1500-DICIRBLU	211
107PBCR	214	124B	218	D12-BAMRL	205	D1200-DIRB	209	D1500-DICIR LD	211
111BCS	214	124BCDMCIFB	218	D12-TAMR	205	D1200-DIRBL	206, 210, 212	D1500-DIRB	211
111CS	214	124BCDWB	218	D12-TAMRBLUL	205	D1200-DIRG	209	D1500-DIRBL	211
113-6	215	125B	217	D12-TAMRBLUL	205	D1200-DISB	209	D1500-DIRBLU	211
113B	215	125BCDMCIFB	217	D15AMR2-B/O	206	D1200-DISBL	206, 210, 212	D1500-DISB	211
113BB	215, 216	125PBCRB	217	D15AMR2-DI	206	D1200-DISBLU	209	D1500-DISBL	211
113BCDMCIF	215	126B	218	D15AMR2-DU B/O	206	D1200-DISBLU	209	D1500-DISBTR	207
113BCDS	215	126BCDMB	218	D15AMR2-OLLOC	206	D1200-DISBSWR	209	D1500-DUB/O	207, 211
113BCDW	215	126BCDMCIFB	218	D15AMR2-OLR	206	D1200-DISBSWRL	210, 212	D1500-DUDICIR	211
113BCE	215	126BCDWB	218	D15AMR2-PS B/O	206	D1200-DISGL	210	D1500-DUDIRB	211
113BCM	215	208BCS	214	D15-BAMR	207	D1200-DISGSWR	209	D1500-DUDISB	211
113BCMCIF	215	211BB	214	D15-BAMRL	207	D1200-DISGSWRL	210	D1500-OLRB	211
113BCR	215	211C ELEC	214	D15-BAMRLP-AM	207	D1200-DITR	205	D1500-OLRBL	211
113BCS	215	211CR	214	D15-BAMRP	207	D1200-DITRL	205	D1500-OLSB	211
113BCW	215	211CRG	214	D15DU-BAMR	207	D1200-DUB/O	210	D1500-OLSBL	211
113CDMCIF	215	211CS	214	D109-B	208	D1200-DUDICIR	209	D1500-OLSGL	211
113CE	215	211CW	214	D109-B/O	208	D1200-DUDIRB	209	D1500P-DU-DICP	211
113CM	215	211PBCR	214	D109-P	208	D1200-DUDISB	209	D1800-B/O	205, 212
113CMCIF	215	212B	214	D109-PL	208	D1200-DUOLSB	210	D1800-B/O NH	212
113CR	215	212BCB ELEC	214	D600E-DISG	205	D1200G-B/O	210	D1800-B/O WHT	212
113CW	215	212BCBS	214	D600E-EXT	205, 210	D1200-OLBLL	210	D1800-DICIR	212
113PBCR	215	212BC ELEC	214	D750E-EXT	207, 211	D1200-OLCIR	210	D1800-DIRB	212
114-6	215	212BCS	214	D1000-RB	208	D1200-OLCIR LD	210	D1800-DISB	212
114CW	215	213C ELEC	215	D1000-RBL	208	D1200-OLCIRSS	210	D1800-OLSG	212
117-6	216	213CS	215	D1000-SB	208	D1200-OLLOCB	210	D2400-18 B/O	213
117B	216	213PBCR	215	D1000-SBL	208	D1200-OLLOCBLD	206, 210	D2400-18LOCSB	213
117B12CW	216	214BCB ELEC	215	D1100-SPL	208	D1200-OLRB	210	D2400-B/O	213
117BCDW	216	214BCS	215	D1200-B/O	205, 210	D1200-OLRBLU	210	D2400-LOCSB	213
117BCS	216	217CR	216	D1200-CI	210	D1200-OLRBLUL	210	D2400-LOCSWBL	213
117CDMCIF	216	217PBCR	216	D1200-CICIR	210	D1200-OLSB	210	DKEY	213

You Click, You Order. No Waiting.

Getting connected is easy... set up your account online, or call customer service. 800-7261994. Se Habla Español.

ndspro.net

The 24 hour online dealer
tool that helps you manage
your NDS Business

Pricing Query

Instant Order Entry, No Wait

Check Discount Schedules

Check Order Status

Invoice Printing

Inventory Query

Manage Your Account

News Updates

Links to ndspro.com
and Literature Direct

METER BOXES



NEW! Shopping Cart
Easy to Use & Convenient

TERMS AND CONDITIONS OF SALE

Terms: Standard terms are NET 30 days. All invoices are to be paid in US Currency. Title and risk of loss pass to buyer upon shipment.

Freight Allowance: Freight prepaid on orders of \$1500.00 NET or more, with the exception of shipments to HI, Canada, AK, and PR Prepaid freight levels are based on shipments to one location only. It is the responsibility of the customer to determine if his purchase order meets the minimum freight allowance required. NDS reserves the right to select the carrier and point of shipment.

Canada, Hawaii, Puerto Rico & Alaska orders that include EZflow must be a minimum of \$4000 for prepaid freight Terms.

Canada, Puerto Rico & Alaska: Freight prepaid on orders of \$2500.00 (US\$) NET or more.

Hawaii Orders: Freight prepaid on orders of \$3500 NET or more.

Errors & Claims: All claims for shortage in shipment or damaged material must be noted on the “Bill of Lading” and a written request for credit submitted to NDS within 15 days of shipment. NDS responsibility ceases upon delivery to the carrier.

Returned Goods: Returned goods will be accepted only after written approval and shipping instructions are received from NDS. A return goods authorization number is required and must be on all cartons, documents, and correspondence. All returns are subject to a 25% restocking charge, freight cost of returned goods (plus “out freight if applicable”). A higher restocking charge may be assessed against any return requiring extraordinary handling costs.

Minimum Order: \$100.00 minimum order net billing.

Broken Box Charge: A 25% broken box charge will be added for other than full box quantities. 21DI Drip Components, 25DS Dura Slope Channel and 25FC Filcoten Channel are excluded from this policy.

Limited One Year Warranty: The liabilities of NDS are limited solely and exclusively to replacement as set forth in our standard “Statement of Warranty”, alone and do not include any liability for incidental, consequential or other damage of any kind whatsoever, whether any claim is based upon theories of contract, warranty, negligence or tort and without any limitations and do not include shipping charges, labor, installation or any other losses or expenses incurred in operation of any replacement specialty item or fitting. NDS drainage products are designed to be used for exterior surface drainage only.

All NDS products are guaranteed against defects resulting from faulty workmanship or materials. Claims for labor costs and other expenses required to replace defective products or repair of any damage resulting from the use thereof will not be allowed by NDS. Our liability is limited to replacement of products acknowledged by NDS to be defective.

Exclusive Warranties and Remedies: The foregoing remedies are exclusive and are given and accepted in lieu of (i) any and all other warranties, expressed or implied, including without limitation the implied warranties of merchantability and fitness for particular purpose; and (ii) any obligation, liability, right, claim or remedy in contract or tort, whether or not arising from NDS, Inc.’s negligence, actual or imputed. The remedies of customer shall be limited to those provided herein to the exclusion of any and all other remedies including, without limitation, incidental or consequential damages. No agreement varying or extending the foregoing warranties or these limitations will be binding on NDS, Inc., unless such is signed in writing by an authorized officer of NDS, Inc.

The liability of NDS, Inc., hereunder shall be limited to restoring to good working order, provided that NDS, Inc., is not required to restore the product to good working order when such failure is due to causes beyond NDS, Inc.’s control, including but not limited to, acts of God, acts of civil or military authority, priorities, strikes, floods, epidemics, war, riots, and other causes that are beyond the manufacturers control.

These provisions are complete and exclusive statements of all terms and conditions between NDS, Inc., and the consumer. These provisions may not be varied, supplemented, qualified or interpreted by any prior course of dealings, written or oral or by trade usage. No NDS, Inc. agent, officer or employee has authority to make any representation, promise or warranty concerning these provisions.

FOR TECHNICAL INFORMATION, CONTACT: Technical Services, (888) 825-4716, TechService@ndspro.com

Visit [ndspro.com](https://www.ndspro.com) for more information.



YEARS AS YOUR KNOWLEDGEABLE AND TRUSTED PARTNER IN WATER MANAGEMENT SOLUTIONS.



Our products are engineered and produced for performance, durability, ease of installation and the efficient use of resources.

Visit ndspro.com for:



Videos



Tools/
Calculators



Downloads



Case
Studies



Design
Worx



Request
a Quote



California Prop 65 Warning | To meet the requirements of California Proposition 65, it is our responsibility to inform you of the following:
Warning Some products sold contain chemicals known to the state of California to cause cancer, birth defects, or other reproductive harm.
For more information, please go to www.P65Warnings.ca.gov

ndspro.com

NDS Customer Service
851 N. Harvard Ave., Lindsay, CA 93247
Phone: 800.726.1994 · 559.562.9888
Fax: 800.726.1998 · 559.562.4488
Se Habla Español

**Download our
Mobile App - Search
for NDS Drainage**



A Proud Member of

