

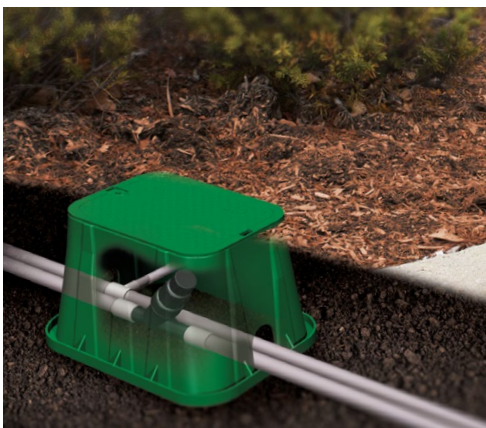

Your knowledgeable and trusted partner  
for the best in water management solutions.

## Product Catalog



Residential and Commercial Drainage | Professional Irrigation | Valve and Meter Boxes | Flow Management

MADE IN  
**USA**

2025-2026 | [ndspro.com](https://ndspro.com)



Since 1972, NDS has been producing plastic drainage and landscape products. From the beginning, our commitment to leading the industry has been unwavering, leading to remarkable innovations and state-of-the-art products that fit every environment, every schedule, every need.

Today, our commitment to providing one-source solutions has led to the development of superior quality drainage products, landscape products, fittings, valve and meter boxes, and drip and micro irrigation products. No product is added to our line without meeting exhaustive testing and extensive research requirements. Plus, NDS is uniquely able to offer our complete inventory of products from regional warehouses in the US and Puerto Rico. Our goal: one-business-day delivery. Our track record: outstanding.

Take a moment to look through this catalog, noting the depth of our product offering. If you have any questions or to place an order, just call 1-800-726-1994 from 5 a.m. to 5 p.m. PST and let us offer the best solution to you.

## Brand Promise



**NDS<sup>®</sup> is your knowledgeable and trusted partner for the best in water management solutions.**

We care about your success and provide industry-leading products, expert guidance, and dedicated support you won't find anywhere else.

# Table of Contents

Drainage	4
Channel & Trench Drains	36
Permeable Pavers	74
Landscape	78
Professional Irrigation	82
Flow Management	112
Fittings & Clamps	142
Access Boxes	164





# Drainage

NDS offers innovative and proven products for subsurface drainage and stormwater management. Our products are the preferred choice of contractors, engineers, landscape architects and even homeowners.



## Product Applications

NDS Drainage products are designed to meet the needs of any size project. We offer solutions that meet capacity and needs for residential and commercial properties including:



### Downspout Runoff

NDS offers solutions to safely and efficiently drain water away from downspouts to avoid pooling water near foundations.



### Landscape Areas and Yards

NDS offers drain grates and subsurface solutions to eliminate muddy and messy areas and protect landscaping.



### Subsurface and Foundation

Engineered solutions such as EZflow® French Drain system, NDS® StormChamber® and Flo-Well® dry well offer proven performance and are lightweight and easy to install.



**Catch Basins**

NDS provides a range of catch basins and grates for stormwater management, from 6" round to 24" square. They include sump areas to collect debris and prevent clogging.



**Grates**

Drain grates prevent leaves and debris from blocking drainage systems. NDS offers a variety of grates, including decorative solutions, brass and cast iron, and colors that work with any environment.



**Pop-Up Drain Emitters**

NDS pop-up emitters safely release captured drainage water away from structures and landscapes. NDS emitters lay flat to blend in, and open only when needed to discharge water.



**EZflow®**

A labor-saving, gravel-free alternative to a traditional French Drain system. EZflow® is available with and without pipe and offers better flow capacity than traditional stone and pipe systems.



**Flo-Well®**

An engineered dry well system, Flo-Well® can be installed with or without gravel or heavy equipment. Units are modular and can be connected for larger volume needs.



**StormChamber® Systems**

StormChamber® systems offer flexibility and easy installation and are a lower cost alternative to drainage pipes with the added benefits of groundwater recharge and water quality enhancement.

## EZflow® Gravel-Free French Drain

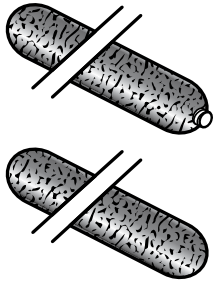

Part No.	Description	Color	Bundle Qty/ Linear Feet	Wt. per Bundle (lbs.)	Product Class	Specifications
EZ-0701F	7" O.D. mesh with 3" slotted pipe (center)	Black	90	36.0	11RP	10 ft. polyethylene slotted drain pipe surrounded by 100% recycled polystyrene aggregate and enclosed in 30-sieve polyethylene geotextile mesh.
EZ-1001F	10" O.D. mesh with 4" slotted pipe (center)	Black	50	30.0	11RP	
EZ-1501F	15" O.D. mesh with 6" slotted pipe (center)	Black	20	26.0	11RP	
EZ-0701A	7" O.D. mesh without pipe – aggregate only	Black	90	18.0	11RP	10 ft. segment of 100% recycled polystyrene aggregate only, enclosed in 30-sieve polyethylene geotextile mesh.
EZ-1001A	10" O.D. mesh without pipe – aggregate only	Black	50	17.0	11RP	
EZ-1501A	15" O.D. mesh without pipe – aggregate only	Black	20	15.0	11RP	

EZflow must be ordered in full bundle quantities, and is not returnable, exchangeable, or refundable.

## EZflow® Storage and Flow Rate (45% void space among consolidated EPS aggregate)

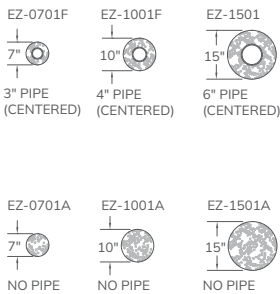

	Storage Volume	Flow Capacity
<b>Slotted Pipe</b>		
EZ-0701F	11.4 gallons per 10 ft. piece	80.8 GPM @ 1% slope
EZ-1001F	21.5 gallons per 10 ft. piece	130.9 GPM @ 1% slope
EZ-1501F	45.8 gallons per 10 ft. piece	345.0 GPM @ 1% slope
<b>Aggregate Only</b>		
EZ-0701A	8.8 gallons per 10 ft. piece	37.1 GPM @ 1% slope
EZ-1001A	17.2 gallons per 10 ft. piece	75.7 GPM @ 1% slope
EZ-1501A	36.5 gallons per 10 ft. piece	170.3 GPM @ 1% slope

## EZflow® Internal Couplings & End Caps

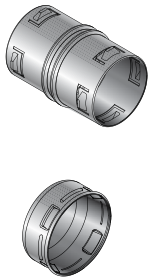

Part No.	Description	Color	Pkg. Qty.	Wt. Ea. (lbs.)	Product Class
3C05	3" Corrugated Internal Coupling	Black	60/box	0.30	11RP
4C07	4" Corrugated Internal Coupling	Black	36/box	0.30	11RP
6C07	6" Corrugated Internal Coupling	Black	12/box	0.80	11RP
3C06	3" Corrugated End Cap	Black	33/box	0.30	11RP
4C06	4" Corrugated End Cap	Black	21/box	0.50	11RP
6C06	6" Corrugated End Cap	Black	15/box	0.50	11RP

We put water in its place™

## NDS® StormChamber® and Accessories



		Dimensions						
Part No.	Description	Color	Length	Width	Height	Weight (lbs.)	Quantity Per Pallet	Product Class
<b>20 Cubic Ft</b>								
SC-1820-S-O	Start Chamber	Orange	102"	39"	18"	53	45	10SC
SC-1820-E-O	End Chamber	Orange	101"	39"	18"	53	45	10SC
SC-1820-M-O	Middle Chamber	Orange	101"	39"	18"	53	45	10SC
SC-1820-C-O	Closed Chamber	Orange	102"	39"	18"	53	45	10SC
<b>75 Cubic Ft</b>								
SC-3475-S-O	Start Chamber	Orange	103"	61"	34"	100	30	10SC
SC-3475-E-O	End Chamber	Orange	103"	61"	34"	100	30	10SC
SC-3475-M-O	Middle Chamber	Orange	103"	61"	34"	100	30	10SC
SC-3475-C-O	Closed Chamber	Orange	103"	61"	34"	100	30	10SC
<b>105 Cubic Ft</b>								
SC-44105-S-O	Start Chamber	Orange	87"	80"	41"	120	20	10SC
SC-44105-E-O	End Chamber	Orange	87"	80"	41"	120	9	10SC
SC-44105-M-O	Middle Chamber	Orange	87"	80"	41"	120	9	10SC
SC-44105-C-O	Closed Chamber	Orange	87"	80"	41"	120	20	10SC
<b>Accessories</b>								
SC-ST	Sediment Trap	Black	47" OD	–	2'	3	4	10SC
SC-2412P	24" X 12" HDPE Pipe, Use with SC-18	Black	24"	–	12"	9.25	20	10SC
SC-NWFF-500	Filter Fabric Non-Woven, Light	Black	360'	12.5'	1.5' OD roll	220	3	10SC
SC-WFF-75	Stabilization Fabric Woven, Medium	Green	75'	7.5'	0.75' OD roll	75	16	10SC
SC-FL-10	10" Frame and Lid for 10" Pipe	Black	16" OD	–	3"	24	–	10SC
SC-3020P	30" X 20" HDPE Pipe	Black	36" OD	–	20"	45	4	10SC

For additional specifications, Refer to Technical Specification documents at [ndspro.com/specifications](https://ndspro.com/specifications)

## Flo-Well® Engineered Dry Well

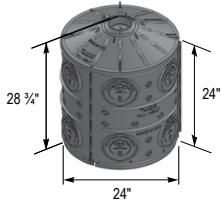

Part No.	Description	Color	Pkg. Qty.	Wt. Ea. (lbs.)	Product Class	Specifications
FWAS24WH	24" diam. x 28.75"H Flo-Well® Stormwater Leaching System	Black	1	18.96	10FW	NDS #FWAS24WH structural foam polyolefin round drywell system with UV inhibitors. 50 gal. storage capacity.
	Includes 3 side panels, 1 top component. Fits 4" Sch. 40 Pipe and 4" DWV Pipe.					

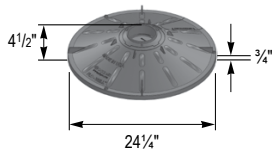

Part No.	Description	Color	Pkg. Qty.	Wt. Ea. (lbs.)	Product Class	Specifications
FWAS24CWH	24" diam. Flo-Well® Cover	Black	2	5.92	10FW	Structural foam polyolefin round drywell system cover with UV inhibitors. 24-1/4" dia., 4-1/2" height, 3/4" outer lip, 4.5" center knockout fits NDS #FWSD69, std pipe and 4" Sch. 40 pipe.
	Use with #FWAS24.					

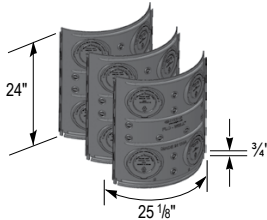

Part No.	Description	Color	Pkg. Qty.	Wt. Ea. (lbs.)	Product Class	Specifications
FWSPS3WH	Flo-Well® Side Panels/Extension Only	Black	1	4.35	10FW	Structural foam polyolefin side panels with UV inhibitors with 22 1-1/2" knockout leaching ports and 4 4.5" knockout inlet/outlet ports per panel. 0.75" lip for firm stacking.
	Includes 3 side panels; makes 1 round drywell. (May also be used as a durable compost bin)					

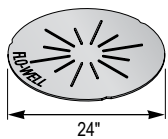

Part No.	Description	Color	Pkg. Qty.	Wt. Ea. (lbs.)	Product Class	Specifications
FWBP24	24" diam. Flo-Well® Bottom	Black	5	3.41	10FW	Structural foam polyolefin round Flo-Well® bottom with UV inhibitors. 24" diameter with six 1-1/2" leaching ports. Collects debris for easy cleanout.
	Fits #FWAS24. (Not included in #FWAS24 kit)					

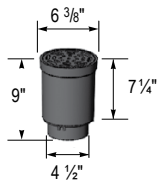

Part No.	Description	Color	Pkg. Qty.	Wt. Ea. (lbs.)	Product Class	Specifications
FWSD69	4" Sch. 40 Surface Drain Inlet with Grate	Black	8	1.85	10FW	Structural foam polyolefin 6" grate with 4" inlet with UV inhibitors. 6" diameter at inlet. 9" high. 4.5" OD fits Sch. 40 PVC fittings. Open surface area 8.22 square inches. 25.15 GPM.
	Fits #FWAS24 and #FWAS24C. ADA Compliant.					

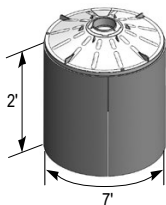

Part No.	Description	Color	Pkg. Qty.	Wt. Ea. (lbs.)	Product Class	Specifications
FWFF67	Porous Filter Fabric Wrap for Flo-Well®	Black	1	0.35	10FW	7' long x 2' wide to surround Flo-Well® Drywell System. Non-woven fabric. Weight 1 oz. Mullen burst 175 psi. 200 GPM flow-through.
	Use with #FWAS24.					



## Catch Basins

### Spee-D® Basins

Use our compact 6" round Spee-D Basins with grates to collect runoff water while its sump area collects debris and prevents clogging. Also use Spee-D Basins with 6" Pop-Up Emitters to provide a point of discharge or overflow in a drainage system.

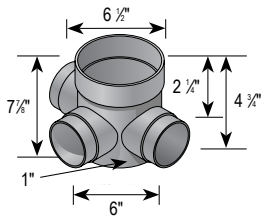
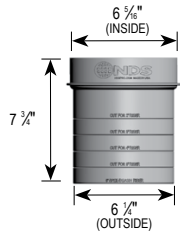
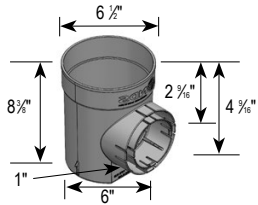

Part No.	Description	Color	Pkg. Qty.	Wt. Ea. (lbs.)	Product Class	Specifications
101	Spee-D Basin with one 3" and 4" Locking Outlet	Black	10	1.60	10ND	<p>Kits contain 1-outlet Spee-D Basin &amp; Grate as described.</p>
101GRKIT	Spee-D Basin with 6" Green Round Grate	Green Grate	6	2.10	10ND	
201	Spee-D Basin with two 3" and 4" Locking Outlets	Black	10	1.83	10ND	
Spee-D Basins and kits fit 3" or 4" Sewer & Drain Pipe, 3" or 4" Corrugated Pipe, 4" Sch. 40 and 3" & 4" Triple Wall Pipe. Use new Spee-D Riser or 6" Sewer and Drain Pipe as a riser for all 6" round catch basins. Use waterproof silicone to make water-tight connections. Locking Outlet snaps on to most 3" and 4" corrugated pipe.						
101R	Spee-D Basin Riser	Black	12	1.07	10ND	6" Riser for Spee-D Basin. Styrene.  Use with any Spee-D Basin to add from 2" to 6" to top of basin. Can be cut to size and has guidelines in 1" increments. Compatible with all grates that fit Spee-D Basin.
Spee-D Basins and kits fit 3" or 4" Sewer & Drain Pipe, 3" or 4" Corrugated Pipe, 4" Sch. 40 and 3" & 4" Triple Wall Pipe. Use new Spee-D Riser or 6" Sewer and Drain Pipe as a riser for all 6" round catch basins. Use waterproof silicone to make water-tight connections. Locking Outlet snaps on to most 3" and 4" corrugated pipe.						
250	Spee-D Basin with wo - 4" 90° Outlets	Black	12	1.64	10ND	6" styrene catch basin with pipe outlets. 153 GPM per outlet capacity.  
300	Spee-D Basin with hree - 4" Outlets	Black	12	1.82	10ND	
350	Spee-D Basin with four - 4" Outlets	Black	12	2.00	10ND	
Fits 4" Sewer & Drain Fittings, use 4P05 Coupling to Connect 4" Sewer & Drain pipe. Use Spee-D Basin Riser 101R or 6" Sewer & Drain pipe as riser extension.						

## 9" Catch Basin Series

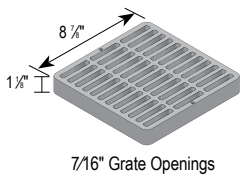
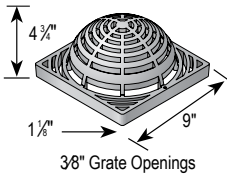
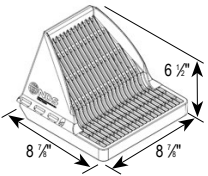
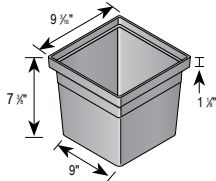
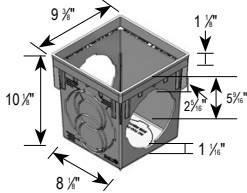

Part No.	Description	Color	Pkg. Qty.	Wt. Ea. (lbs.)	Product Class	Specifications
900FF	9" Catch Basin Filter	Blue Frame/ Black Bag	8	0.18	10ND	Polypropylene Frame Fabric is non-woven geotextile 95 PM/SM.
Compatible with these basins: 900, 900-4 and 916 NDS Catch Basins, Risers and Kits						

900BLKIT	9" x 9" Catch Basin Kit w/ #980 Grate	Black Grate	4	5.30	10ND	9" x 9" tapered Catch Basin. Polypropylene. Kits include 2-opening Catch Basin, Grate, Screws, (1) 1243 Outlet, (1) 1245 offset outlet, and (1) Plug.
900GRKIT	9" x 9" Catch Basin Kit w/ #990 Grate	Green Grate	4	5.30	10ND	
900SKIT	9" x 9" Catch Basin Kit w/ #990 Grate	Sand Grate	4	5.30	10ND	
900KITDISP	9" x 9" Catch Basin Kits in Display Box	Blk/Grn Grates	8	5.0 each	10ND	
900	9" x 9" Catch Basin 2-opening	Black	4	3.0	10ND	
900-4	9" x 9" Catch Basin 4-opening	Black	4	2.00	10ND	DISP includes 4 kits with (4) black grates and (4) green.
900MTLKIT	9" x 9" Catch Basin Kit, Galvanized Grate	Galvanized Grate	1	6.75	10ND	
Requires either #1206, #1243, #1245 or #1266 Universal Outlet to connect pipe to basin (see page 18)						

916	9" x 9" Catch Basin Riser	Black	4	1.75	10ND	6" Riser for 9" x 9" Catch Basin. Styrene.
Use with 9" x 9" Catch Basin Series. Stacks on top of 9" catch basins to add up to 6" to top of basin. Can be cut to size.						

900DSG	9" x 9" Downspout Defender Grate	Black	4	0.8	10ND	9" x 9" Downspout Grate, Structural Foam Polyolefin with UV inhibitors. 146 GPM.
Fits all NDS 9" square Catch Basins, Risers and Low-Profile Adapters						
900DSGKIT	9" x 9" Low-Profile Downspout Kit	Black	4	2.25	10ND	Kit includes 9" Downspout Defender Grate, (1) 930 low-profile adapter and (1) 1243 outlet adapter. 146 GPM.
Receives downspouts from 2" to 4" round or square. Fits 3" & 4" Corrugated Pipe, 3" & 4" Sewer and Drain Pipe, 4" Sewer and Drain Fittings, 4" Schedule 40 Pipe, and 3" & 4" Triple Wall Pipe.						

981	9" x 9" Atrium Grate	Black	6	0.87	10ND	9" Structural Foam Polyolefin Dome Atrium Grate with UV inhibitor. Open surface area: 31.50 square inches. 96.36 GPM.
991	9" x 9" Atrium Grate	Green	6	0.87	10ND	
Use with 9" x 9" Catch Basin Series.						

980	9" Square Grate	Black	8	1.50	10ND	9" Square Structural Foam Polyolefin Grate with UV inhibitor. Open surface area: 37.49 square inches. 114.69 GPM.
990	9" Square Grate	Green	8	1.50	10ND	
999	9" Square Grate	Gray	8	1.50	10ND	
999S	9" Square Grate	Sand	8	1.50	10ND	
Use with 9" x 9" Catch Basin Series. PH # 6 - 1 1/2" screws required. NDS #980, 990, 999, 999S: Class A Load Rated. ADA Compliant, see page 71.						

9" Catch Basin Series, continued

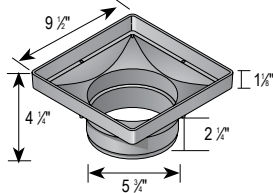
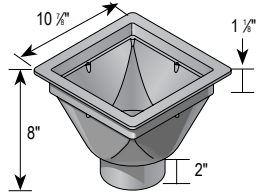
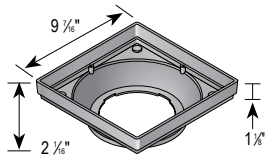
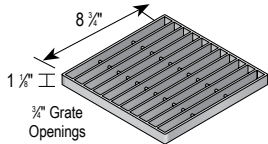
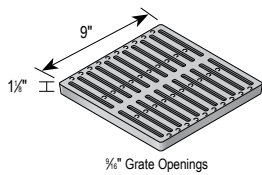
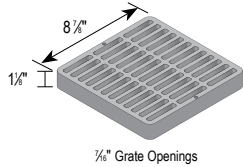

Part No.	Description	Color	Pkg. Qty.	Wt. Ea. (lbs.)	Product Class	Specifications
930B	9" Square Brass Grate	Brass	1	5.11	15BR	Open surface area: 34.00 square inches. 104.01 GPM. Includes SS Screws.
	Use with 9" x 9" Catch Basin Series. Class B Load Rated. ADA Compliant, see page 71.					

913	9" Square Ductile Iron Grate	Black*	4	8.0	10ND	9" Square Heavy-Duty Ductile Iron Grate. Open surface area: 21.70 square inches. 66.38 GPM.
	No screws required. Use with 9" x 9" Catch Basin Series. Class C Load Rated, see page 71. *Painted for shipping & display only; grate will form iron-oxide patina					

915	9" Square Galvanized Steel Grate	Galvanized Steel	4	3.80	10ND	9" Square Heavy-Duty Galvanized Steel Bar Grate. Open surface area: 61.94 square inches. 189.48 GPM.
	No screws required. Use with 9" x 9" Catch Basin Series. Class D Load Rated, see page 71.					

930	9" x 9" Low-Profile Adapter	Black	8	0.75	10ND	9" x 9" Low-Profile Adapter. Styrene. Kits contain Low-Profile Adapter, 3" & 4" Universal Locking Outlet and Grate as described.
930GRKIT	9" x 9" Low-Profile Adapter with Flat Green Grate and 3" & 4" Universal Locking Outlet	Green Grate	8	n/a	10ND	
Adapter alone requires #1243, #1245, #1266 or #1889 Universal Outlets (see page 18) to connect to 3", 4", 6" or 8" Sewer and Drain or Corrugated Pipes. Kits contain #1243 outlet.						

931	9" x 9" Deep Housing Spigot Adapter	Black	10	2.40	10ND	9" x 9" Square Deep Housing Spigot Adapter. Styrene. Fits 4" Corrugated Pipe.

932	9" x 9" Low-Profile Housing Adapter	Black	8	1.13	10ND	NDS #932, 9" x 9" Square Low-Profile Housing Adapter with 6" Outlet. Styrene. Fits 6" Spee-D® Basin and 6" Sewer and Drain Pipe & Fittings.

## 12" Catch Basin Series

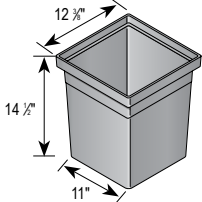
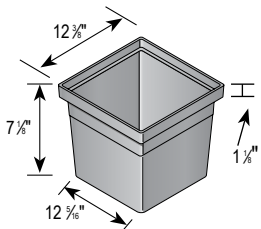
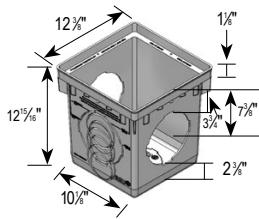
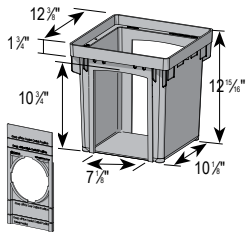

Part No.	Description	Color	Pkg. Qty.	Wt. Ea. (lbs.)	Product Class	Specifications
1200FF	12" Catch Basin Filter	Blue Frame/ Black Bag	8	0.10	10ND	Polypropylene Frame Fabric is non-woven geotextile 95 PM/SM.
	Compatible with all NDS 12"x12" grates except plastic botanical 1218, 1218GR, 1218GY, 1218S.					

1200NGBKIT	12" x 12" Catch Basin, 2 Open Slides	Black	4	4.65	10ND	Adjustable Outlet Catch Basin. Sides adjust to 3 different outlet elevations. Polypropylene basin and styrene sides.
	Compatible with 12" x 12" Catch Basin Risers and Grates. Does not include grate or outlets					

1200BLKIT	12" x 12" Catch Basin Kit	Black Grate	4	7.59	10ND	12" x 12" Tapered Catch Basin. Polypropylene.
1200GRKIT	12" x 12" Catch Basin Kit	Green Grate	4	7.59	10ND	
1200SKIT	12" x 12" Catch Basin Kit	Sand Grate	4	7.59	10ND	
1200MTLKIT	12" x 12" Catch Basin Kit w/Galvanized Steel Grate	Galvanized Steel	1	9.79	10ND	
1200KITDISP	12" x 12" Catch Basin Kits in Display Box	Blk/Grn Grates	8	7.59	10ND	Kits include 2-opening Catch Basin, Grate, Screws, (1) 1243 Outlet, (1) 1245 offset outlet, and (1) Plug
1200	12" x 12" Catch Basin, 2 Openings	Black	4	4.25	10ND	DISP includes 4 kits with (4) black grates and (4) green
1203	12" x 12" Catch Basin, 3 Openings	Black	4	3.75	10ND	
1204	12" x 12" Catch Basin, 4 Openings	Black	4	3.75	10ND	
	1200, 1203, and 1204 do not include grate or outlets. Requires #1206, #1243, #1245, #1266 or #1889 Universal Outlet to connect pipe to basin (see page 18). Bottom cutout can be removed.					

1216	12" x 12" Catch Basin Riser	Black	8	2.75	10ND	6" Riser for 12" Catch Basin. Styrene.
	Use with 12" x 12" Catch Basin Series. Stacks on top of 12" catch basins to add up to 6" to top of basin. Can be cut to size.					

1225	12" x 12" Sump Box	Black	4	6.75	10ND	One-piece 12" Sump Box. Styrene.
	Use with 12" x 12" Grate #1216 or #1220 Sump/Valve Box Cover					

## 12" Catch Basin Series, continued

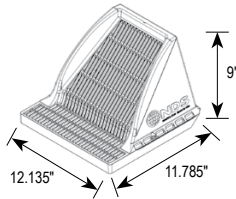

Part No.	Description	Color	Pkg. Qty.	Wt. Ea. (lbs.)	Product Class	Specifications
1200DSG	12" x 12" Downspout Defender Gate	Black	8	n/a	10ND	12" x 12" Downspout Gate. Structural Foam Polyolefin with UV inhibitor. 247 GPM.
Receives downspouts from 2" to 6" round or square. Fits all NDS 12" square Catch Basins, Risers and Low-Profile adapters.						

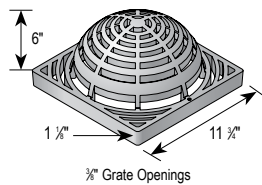

1280	12" x 12" Atrium Gate	Green	8	1.74	10ND	12" Structural Foam Polyolefin Dome Atrium Gate with UV inhibitor. Open surface area 50.60 square inches. 154.79 GPM.
1290	12" x 12" Atrium Gate	Black	8	1.74	10ND	
Use with 12" x 12" Catch Basin Series.						

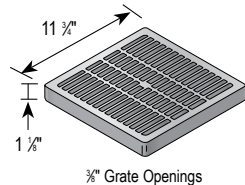

1210	12" x 12" Square Gate	Gray	8	2.33	10ND	12" Square Structural Foam Polyolefin Gate with UV inhibitor. Open surface area 50.76 square inches. 155.28 GPM.
1211	12" x 12" Square Gate	Black	8	2.33	10ND	
1212	12" x 12" Square Gate	Green	8	2.33	10ND	
1212S	12" x 12" Square Gate	Sand	8	2.33	10ND	
Use with 12" x 12" Catch Basin Series. ADA Compliant, see page 71.						

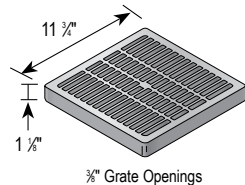

1230B	12" Square Brass Gate	Brass	1	9.24	15BR	Open surface area 42.87 square inches. 131.14 GPM. Includes SS Screws. Class B load rated.
*Painted for shipping & display only; grate will form iron-oxide patina. ADA Compliant, see page 71.						

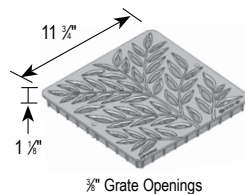

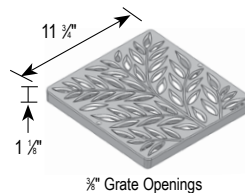

1218S	12" x 12" Square Botanical Gate	Sand	8	3.27	10ND	12" Square Structural Foam Polyolefin Botanical Gate with UV inhibitor. Open surface area 24.44 square inches. 74.77 GPM.
1218GR	12" x 12" Square Botanical Gate	Green	8	3.27	10ND	
1218GY	12" x 12" Square Botanical Gate	Gray	8	3.27	10ND	
1218	12" x 12" Square Botanical Gate	Black	8	3.27	10ND	
ADA Compliant, see page 71.						



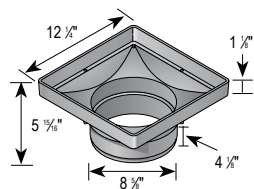
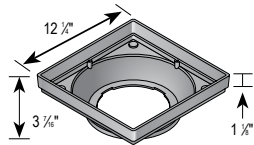
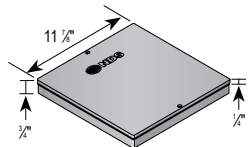
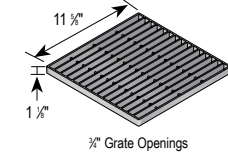
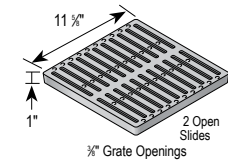
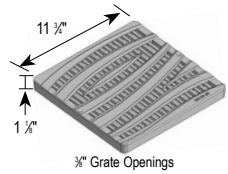
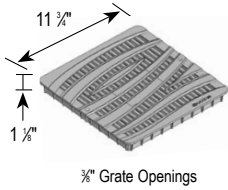

1218CI	12" x 12" Square Botanical Cast Iron Gate	Black*	1	12.67	10ND	12" Square Cast Iron Botanical Gate. Open surface area 24.44 square inches. 74.77 GPM. Class B load rated.
629	Stainless Steel Screws, FH 1/4-20 x 1-3/4"	Metal	40/Bag	n/a	10ND	
*Painted for shipping & display only; grate will form iron-oxide patina. ADA Compliant, see page 71.						

## 12" Catch Basin Series, continued



Part No.	Description	Color	Pkg. Qty.	Wt. Ea. (lbs.)	Product Class	Specifications
1224S	12" x 12" Square Wave Grate	Sand	8	2.68	10ND	12" Square Structural Foam Polyolefin Wave Grate with UV inhibitor. Open surface area 25.67 square inches. 78.53 GPM.
1224GR	12" x 12" Square Wave Grate	Green	8	2.68	10ND	
1224GY	12" x 12" Square Wave Grate	Gray	8	2.68	10ND	
1224	12" x 12" Square Wave Grate	Black	8	2.68	10ND	
	ADA Compliant, see page 71.					

1224CI	12" x 12" Square Wave Cast Iron Grate	Black*	1	13.90	10ND	12" Square Cast Iron Wave Grate. Open surface area 25.60 square inches. 78.31 GPM. Class B load rated.
629	Stainless Steel Screws, FH 1/4-20 x 1-3/4"	Metal	40	n/a	10ND	
	*Painted for shipping & display only; grate will form iron-oxide patina ADA Compliant/Heel-proof, see page 71.					

1213	12" x 12" Square Ductile Iron Grate	Black*	1	15.30	10ND	12" Square Heavy-Duty Ductile Iron Grate. Open surface area 37.20 square inches. 113.80 GPM. Class C load rated.
	Use with 12" x 12" Catch Basin Series. *Painted for shipping & display only; grate will form iron-oxide patina ADA Compliant, see page 71.					

1215	12" x 12" Square Galvanized Steel Grate	Galvanized Steel	1	5.85	10ND	12" Square Heavy-Duty Galvanized Steel Bar Grate. Open surface area 113.78 square inches. 348.07 GPM. Class C load rated.
	Use with 12" x 12" Catch Basin Series. See page 71.					

1220	12" x 12" Sump/Valve Box Cover	Black	8	2.23	10ND	NDS #1220, 12" Square Structural Foam Polyolefin Solid Cover.
	Use with NDS 12" x 12" Catch Basin Series, #1225 Sump Box and #1219 Backwater Valve Box.					

1230	12" x 12" Low-Profile Adapter	Black	8	1.25	10ND	12" x 12" Low-Profile Adapter. Styrene.
	Adapter #1242, #1243, #1245, #1266 or #1889 Universal Outlets to connect to 3", 4", 6" or 8" Sewer and Drain or Corrugated Pipes.					

1221	12" x 12" Square, Low-Profile Spigot Adapter – Fits 8" Sewer and Drain Pipe and Schedule 40 Pipe and Dual-wall N-12 Corrugated Pipe	Black	12	1.92	10ND	12" x 12" Low-Profile Adapter. Styrene.
1222	12" x 12" Square, Low-Profile Spigot Adapter – Fits 8" single-wall corrugated pipe.	Black	12	1.92	10ND	
	Use with NDS 12" x 12" Grates					

18" Catch Basin Series

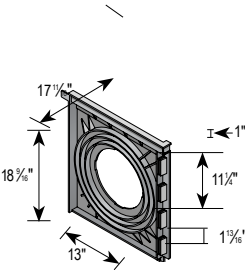

Part No.	Description	Color	Pkg. Qty.	Wt. Ea. (lbs.)	Product Class	Specifications
1882	18" One-Piece Catch Basin 2 Openings	Black	1	10.00	10ND	18"x18" One-Piece Tapered Catch Basin. Structural Foam Polyolefin. Kits include 2-opening Catch Basin, Grate, Screws, 6" Outlet, 8" Outlet, Reducer Rings and Plug
1882BLKIT	18" Catch Basin Kit with Black Plastic Grate	Black Grate		21.00	10ND	
1882GRKIT	18" Catch Basin Kit with Green Plastic Grate	Green Grate	1	21.00	10ND	
1884	18" One-Piece Catch Basin 4 Openings	Black	1	9.65	10ND	
Requires either #1206, #1242, #1243, #1245, #1266, #1888 or #1889 Universal Outlet to connect pipe to basin. Includes 2 or 4 #1890 Reducer Rings.						

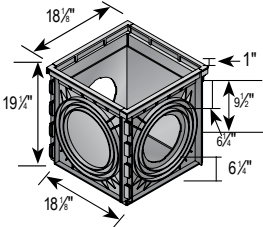

1800	18" x 18" Catch Basin 2 Openings	Black	1	16.00	10ND	18" x 18" Modular Catch Basin with Locking Tabs. Styrene.
1804	18" x 18" Catch Basin 4 Openings	Black	1	16.00	10ND	
Assembly Required. #1800 includes: 2 #1822, 2 #1820, 1 #1828. #1804 includes: 4 #1822, 1 #1828. Use #1800 and #1804 with #1206, #1243, #1245, #1266 or #1888 Universal Outlets to connect pipes to basin. Includes 2 or 4 #1890 Reducer Rings. (Note: Use Silicone to seal joints.)						

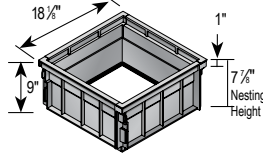

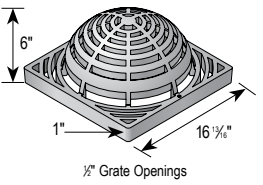

1816	8" Riser for 18" Catch Basin	Black	1	6.00	10ND	8" Riser for 18" x 18" Catch Basin. Styrene.
Riser package includes 4 sides. Use with #1800, #1804, #1882 or #1884.						

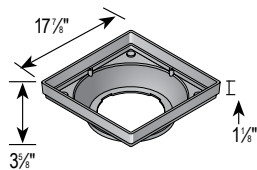
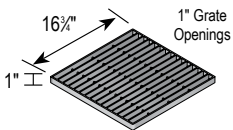
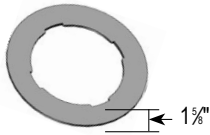
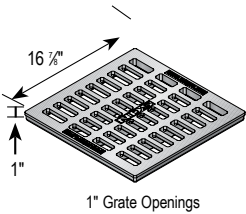
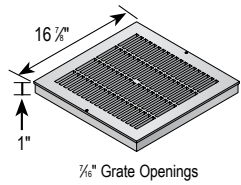

1881	18" x 18" Atrium Grate	Black	2	6.51	10ND	18" Structural Foam Polyolefin Dome Atrium Grate with UV inhibitor. Open surface area 89.40 square inches. 273.49 GPM.
1891	18" x 18" Atrium Grate	Green	2	6.51	10ND	
Use with 18" x 18" Catch Basin Series.						

## 18" Catch Basin Series, continued



Part No.	Description	Color	Pkg. Qty.	Wt. Ea. (lbs.)	Product Class	Specifications
1810	18" x 18" Square Grate	Gray	4	7.72	10ND	18" Square Structural Foam Polyolefin Grate with UV inhibitor. Open surface area 86.31 square inches. 264.03 GPM.
1811	18" x 18" Square Grate	Black	4	7.72	10ND	
1812	18" x 18" Square Grate	Green	4	7.72	10ND	
	Use with 18" x 18" Catch Basin Series. ADA Compliant, see page 71.					

1813	18" x 18" Cast Iron Square Grate	Black*	1	46.00	10ND	18" Square Heavy-Duty Cast Iron Grate. Open surface area 110.70 square inches. 338.65 GPM. Class C Load Rated.
	No screws required. Use with 18" x 18" Catch Basin Series. *Painted for shipping & display only; grate will form iron-oxide patina					

1890	Universal Outlet Reducer Ring	Black	8	0.33	10ND	Styrene. Required on #1821 basin side when using 3", 4" or 6" pipe. Required on #1821 basin side when connecting to #1206, #1243, #1245, #1266 or #1889 Universal Outlets.

1815	18" Square Galvanized Steel Grate	Galvanized Steel	1	10.78	10ND	18" Square Heavy-Duty Galvanized Steel Bar Grate. Open surface area 239.00 square inches. 731.13 GPM. Class C Load Rated.
	No screws required. Use with 18" x 18" Catch Basin Series.					

1830	18" x 18" Low-Profile Adapter	Black	4	4.75	10ND	18" x 18" Low-Profile Adapter. Styrene. Includes NDS #1890 Reducer Ring. Requires either an NDS #1243, #1245, #1266 or #1888 Universal Outlet to connect to pipe, see .



## 24" Catch Basin Series

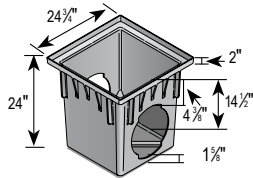

Part No.	Description	Color	Pkg. Qty.	Wt. Ea. (lbs.)	Product Class	Specifications
2400	24" x 24" Catch Basin, 2 Openings	Black	1	18.00	10ND	24" x 24" One-Piece Tapered Catch Basin. HDPE with Structural Foam.  Kits include 2-opening Catch Basin, Grate, 12"/10" Outlets, 8" Outlet, Reducer Rings and Plug
2400BLKIT	24" Catch Basin Kit with Black Plastic Grate	Black Grate		50.00	10ND	
2400GRKIT	24" Catch Basin Kit with Green Plastic Grate	Green Grate	1	50.00	10ND	
2404	24" x 24" Catch Basin, 4 Openings	Black	1	15.00	10ND	
#2400 & #2404 Require 2 or 4 #2410 Universal Outlets.						

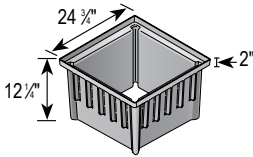

2418	24" x 24" Catch Basin Extension (No Bottom)	Black	1	14.60	10ND	8" Extension for 24" x 24" Catch Basin. HDPE with Structural Foam.
Use with 24" x 24" Catch Basin Series.						

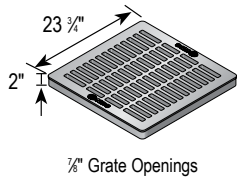

2411	24" x 24" Square Grate	Black	1	19.75	10ND	24" Square HDPE with Structural Foam Grate with UV inhibitor. Open surface area 231.69 square inches. 708.77 GPM.
2412	24" x 24" Square Grate	Green	1	19.75	10ND	
No screws required. Use with 24" x 24" Catch Basin Series. See page 71.						

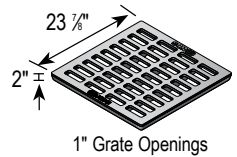

2413	24" x 24" Square Cast Iron Grate	Black*	1	147.00	10ND	24" Square Heavy-Duty Cast Iron Grate. Open surface area 197.00 square inches. 602.65 GPM.
No screws required. Use with 24" x 24" Catch Basin Series. See page 71. *Painted for shipping & display only; grate will form iron-oxide patina						

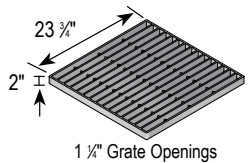

2415	24" x 24" Square Galvanized Steel Grate	Galvanized Steel	1	62.88	10ND	24" Square Heavy-Duty Galvanized Steel Bar Grate. Open surface area 422.45 square inches. 1292.33 GPM. Class C Load Rated.
No screws required. Use with 24" x 24" Catch Basin Series. See page 71.						

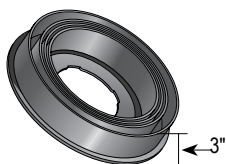

2410	10" & 12" Universal Adapter	Black	1	4.20	10ND	10"/12" Universal Adapter. HDPE.
Includes #1890 (comes pre-inserted). Fits 10" and 12" Sewer and Drain Pipe; 10" and 12" Dual Wall Corrugated Pipe; 12" Single Wall Corrugated Pipe (does not fit 10" Single Wall Corrugated Pipe). Reduces opening to fit most 3" to 8" adapters above (all except #1889) for use with 3", 4", 6" and 8" Sewer and Drain Pipe; 3", 4", 6" and 8" Corrugated Pipe; and 4" Sch. 40 Pipe (select corresponding adapter above). Use with 24" Catch Basin Series.						

## Catch Basin Universal Outlets

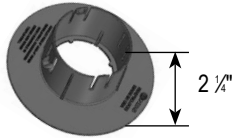

Part No.	Description	Color	Pkg. Qty.	Wt. Ea. (lbs.)	Product Class	Specifications
1243	3" & 4" Universal Locking Outlet*	Black	20	0.60	10ND	3" & 4" Patented Universal Locking Outlet. Styrene.
	Fits 3" & 4" Corrugated Pipe, 3" & 4" Sewer and Drain Pipe, 4" Sch. 40 Pipe and 3" & 4" Triple Wall Pipe. Use with 9", 12", 18" and 24" Catch Basin Series and #930, #1230, #1830 and #2410 Adapters. Use with 24" Catch Basin also requires #2410 Adapter. *Locking Outlet snaps on to most 3" and 4" corrugated pipe.					

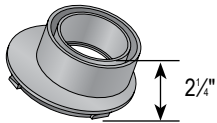

1245	3" & 4" Offset Universal Outlet	Black	20	0.50	10ND	3" & 4" Offset Universal Outlet. Styrene.
	Fits 3" & 4" Corrugated Pipe, 3" & 4" Sewer and Drain Pipe, 4" Sch. 40 Pipe, 4" Triple Wall Pipe. Allows for adjusting inlet height. Use with 9", 12", 18" and 24" Catch Basin Series. Use with 24" Catch Basin also requires #2410 Adapter.					

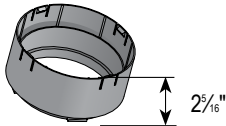

1266	6" Universal Locking Outlet*	Black	20	0.55	10ND	6" Universal Locking Outlet. Styrene.
	Fits 6" Sewer and Drain Pipe, 6" Corrugated Pipe. Use with 9", 12", 18" and 24" Catch Basin Series and #930, #1230 and #1830 Low-Profile Adapters. Use with 24" Catch Basin also requires #2410 Adapter. *Locking Outlet snaps on to most 6" corrugated pipe.					

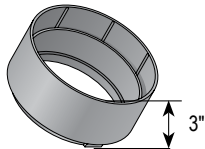

1888	8" Universal Outlet	Black	8	1.05	10ND	8" Universal Outlet. Styrene.
	Fits 8" Sewer and Drain Pipe, 8" Corrugated Pipe. Use with 18" and 24" Catch Basin Series. Use with 24" Catch Basin also requires #2410 Adapter.					

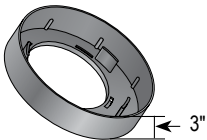

1889	8" Offset Universal Adapter	Black	10	0.74	10ND	8" Offset Universal Adapter. Styrene.
	Fits 8" Sewer and Drain Pipe, 8" Corrugated Pipe. Use with 12" and most 18" Catch Basin Series (except 1800 and 1804).					

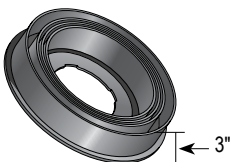

2410	10" & 12" Universal Adapter	Black	1	4.20	10ND	10"/12" Universal Adapter. HDPE.
	Includes #1890 (comes pre-inserted). Fits 10" and 12" Sewer and Drain Pipe; 10" and 12" Dual Wall Corrugated Pipe; 12" Single Wall Corrugated Pipe (does not fit 10" Single Wall Corrugated Pipe). Reduces opening to fit most 3" to 8" adapters above (all except #1889) for use with 3", 4", 6" and 8" Sewer and Drain Pipe; 3", 4", 6" and 8" Corrugated Pipe; and 4" Sch. 40 Pipe (select corresponding adapter above). Use with 24" Catch Basin Series.					

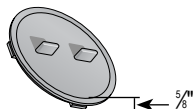

1206	6" Universal Adapter Plug	Black	20	0.35	10ND	Universal Plug. Styrene.
------	---------------------------	-------	----	------	------	--------------------------

Pop-Up Drainage Emitters

3" & 4" Pop-up Drainage Emitters

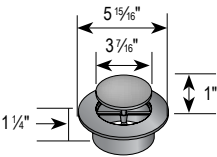

Part No.	Description	Color	Pkg. Qty.	Wt. Ea. (lbs.)	Product Class	Specifications
420	3" & 4" Pop-up Drainage Emitter	Green	20	0.28	10ND	3" and 4" polyolefin spring-loaded Pop-up Drainage Emitter with UV inhibitor. 43 GPM outflow capacity with 1" system head. 0.04 psi or 1" of head to raise top.
	Fits 3" and 4" Sewer and Drain Fittings. Ideal for discharging excess water from stormwater management system. Spring automatically retracts.					

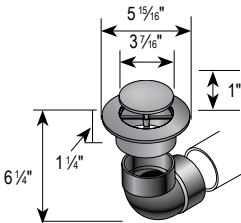

321	Emitter with 3" Elbow	Green	25	0.60	10ND	NDS #420 polyolefin spring-loaded Pop-up Drainage Emitter with UV inhibitor, 3" styrene 90 degree elbow with 1/4" drain hole. 40 GPM outflow capacity with 1" system head. 0.04 psi or 1" of head to raise top.
	Fits 3" Sewer and Drain Pipe. Ideal for discharging excess water from stormwater management system. Spring automatically retracts.					

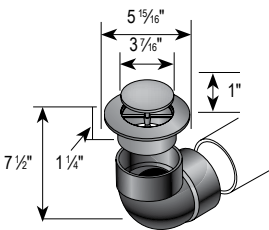

421	Emitter with 4" Elbow	Green	20	0.85	10ND	NDS #420 polyolefin spring-loaded Pop-up Drainage Emitter with UV inhibitor, 4" styrene 90 degree elbow with 1/4" drain hole. 43 GPM outflow capacity with 1" system head. 0.04 psi or 1" of head to raise top.
	Fits 4" Sewer and Drain Pipe. Ideal for discharging excess water from stormwater management system. Spring automatically retracts.					

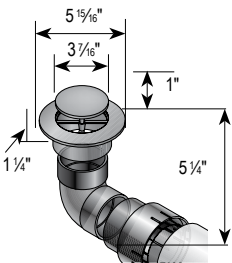

430	Pop-up Drainage Emitter with 3" Elbow and Universal Adapter	Green	20	1.00	10ND	NDS #420 polyolefin spring-loaded Pop-up Drainage Emitter with UV inhibitor, 3" styrene 90 degree elbow with 1/4" drain hole and #1241 universal pipe adapter. 43 GPM outflow capacity with 1" system head. 0.04 psi or 1" of head to raise top.
	Universal Adapter fits 3" and 4" corrugated pipe, 3" and 4" sewer and drain pipe, 4" Sch. 40 pipe, and 3" and 4" triple wall pipe. Ideal for discharging excess water from stormwater management system. Spring automatically retracts.					

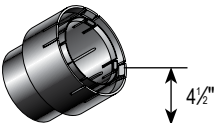

1241	3" & 4" Universal Adapter w/4" Spigot	Black	20	0.70	10ND	3" & 4" Patented Universal Adapter. Styrene.
	Connects 3" & 4" Sewer and Drain Fittings with 3" & 4" Corrugated Pipe, 3" & 4" Sewer and Drain Pipe, 4" Sch. 40 Pipe and 3" & 4" Triple Wall Pipe.					

## 6" Pop-up Drainage Emitters

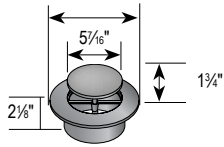

Part No.	Description	Color	Pkg. Qty.	Wt. Ea. (lbs.)	Product Class	Specifications
620	6" Pop-up Drainage Emitter	Green	15	0.61	10ND	6" polyolefin spring-loaded Pop-up Drainage Emitter with UV inhibitor. 125 GPM outflow capacity with 1" system head. 0.04 psi or 1" of head to raise top.
	Can be used with Flo-Well to relieve overflow.					

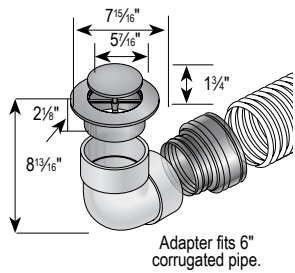

624	6" Pop-up Emitter with Elbow and Corrugated Pipe Adapter	Green	10	3.45	10ND	NDS #620 polyolefin spring-loaded Pop-up Drainage Emitter with UV inhibitor, 6" styrene 90 degree elbow with 1/4" drain hole and corrugated pipe adapter. 125 GPM outflow capacity with 1" system head. 0.04 psi or 1" of head to raise top.
-----	--	-------	----	------	------	--

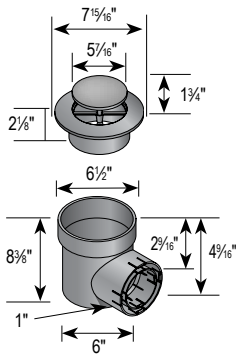

625	6" Pop-up Emitter with Spee-D® Basin	Green	8	2.21	10ND	NDS #620 polyolefin spring-loaded Pop-up Drainage Emitter with UV inhibitor and Spee-D basin. 125 GPM outflow capacity with 1" system head. 0.04 psi or 1" of head to raise top.
	3" - 4" S & D, Corrugated, Single Wall, Dual Wall, Triple Wall.					

## Common Drainage Fittings

### 90 Degree PVC Elbow

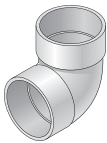

Part No.	Description	Color	Pkg. Qty.	Wt. Ea. (lbs.)	Product Class
3P02	3" PVC 90 Degree Elbow (HUB x HUB)	White	40	0.40	30PV
4P02	4" PVC 90 Degree Elbow (HUB x HUB)	White	25	0.68	30PV
6P02	6" PVC 90 Degree Elbow (HUB x HUB)	White	12	3.00	30PV

### Corrugated Adapter

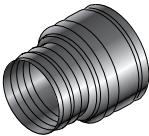

Part No.	Description	Color	Pkg. Qty.	Wt. Ea. (lbs.)	Product Class
351	3" Polyethylene Corrugated Adapter (CORR HUB x S&D SPT or HUB)	Black	50	0.10	30ST
451	4" Polyethylene Corrugated Adapter (CORR HUB x S&D SPT or HUB)	Black	25	0.20	30ST
651	6" Polyethylene Corrugated Adapter (CORR HUB x S&D SPT or HUB)	Black	12	0.25	30ST

### Corrugated Internal Couplings

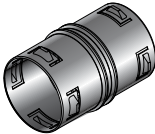

Part No.	Description	Color	Pkg. Qty.	Wt. Ea. (lbs.)	Product Class
3C05	3" Corrugated Coupling	Black	60	0.07	30PE
4C07	4" Corrugated Coupling	Black	36	0.08	30PE
6C07	6" Corrugated Coupling	Black	12	0.08	30PE

### Corrugated End Caps

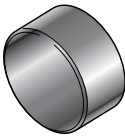



Part No.	Description	Color	Pkg. Qty.	Wt. Ea. (lbs.)	Product Class
3C06	3" Corrugated Endcap	Black	33	0.05	30PE
4C06	4" Corrugated Endcap	Black	30	0.06	30PE
6C06	6" Corrugated Endcap	Black	15	0.50	30PE

See Fittings section, pages 142-162, for additional fitting options.

## Grates: Metal, Decorative & Standard

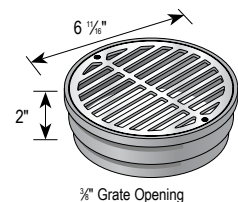
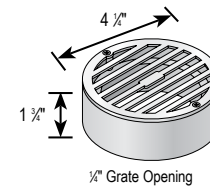
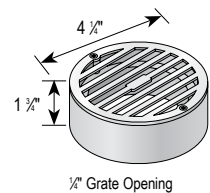
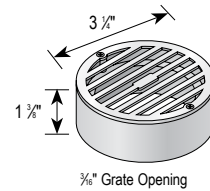
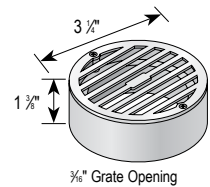
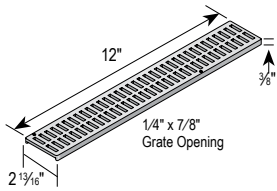
### Brass & Chrome Grates





Part No.	Description	Color	Pkg. Qty.	Wt. Ea. (lbs.)	Product Class	Specifications
552B	1 ft. Brass Channel Grate	Satin Brass	12	1.21	25PF	1 foot Mini Channel Solid Brass Grate with brass screws. Open surface area 9.20 square inches per foot. 28.14 GPM per foot.
553PB	1 ft. Brass Channel Grate	Polished Brass	12	1.21	25PF	
	Fits #500 Mini Channels, see page 43. ADA Compliant/Heel-proof, see page 71.					

909B	3" Round Brass Grate w/PVC Collar	Satin Brass	20	0.40	15BR	3" Round Solid Brass Grate and brass screws with PVC collar. Open surface area 2.68 square inches. 8.20 GPM.
905PB	3" Round Brass Grate w/PVC Collar	Polished Brass	20	0.40	15BR	
	Fits 2" SCH-40 Pipe and 3" Sewer and Drain Fittings. ADA Compliant/Heel-proof, see page 71					

915SC	3" Round Chrome Grate w/PVC Collar	Satin Chrome	20	0.40	15BR	3" Round Solid Chrome Grate and screws with PVC collar. Open surface area 2.68 square inches. 8.20 GPM.
907PC	3" Round Chrome Grate w/PVC Collar	Polished Chrome	20	0.40	15BR	
	Fits 3" Sewer and Drain Fittings and 2" SCH-40 Pipe. ADA Compliant/Heel-proof, see page 71.					

910B	4" Round Brass Grate w/PVC Collar	Satin Brass	20	0.64	15BR	4" Round Solid Brass Grate and brass screws with PVC collar. Open surface area 5.25 square inches. 16.06 GPM.
906PB	4" Round Brass Grate w/PVC Collar	Polished Brass	20	0.64	15BR	
	Fits 3" Sewer & Drain Pipe, 4" Sewer & Drain Fittings. ADA Compliant/Heel-proof, see page 71.					

917SC	4" Round Chrome Grate w/PVC Collar	Satin Chrome	20	0.66	15BR	4" Round Chrome Grate and screws with PVC collar. Open surface area 5.25 square inches. 16.06 GPM.
908PC	4" Round Chrome Grate w/PVC Collar	Polished Chrome	20	0.66	15BR	
	Fits 3" Sewer & Drain Pipe, 4" Sewer & Drain Fittings. ADA Compliant/Heel-proof, see page 71.					

918B	6" Round Brass Grate w/Styrene Collar	Satin Brass	8	1.38	15BR	6" Round Solid Brass Grate and brass screws with styrene collar. Open surface area 13.10 square inches. 40.07 GPM.
919PB	6" Round Brass Grate w/Styrene Collar	Polished Brass	8	1.38	15BR	
	Fits Spee-D® Basin, 6" Sewer & Drain Fittings. ADA Compliant, see page 71.					

Brass & Chrome Grates, continued

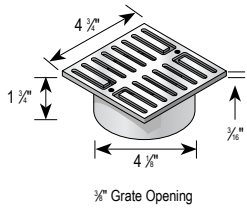

Part No.	Description	Color	Pkg. Qty.	Wt. Ea. (lbs.)	Product Class	Specifications
913B	5" Square Brass Grate w/PVC Collar	Satin Brass	10	1.21	15BR	5" Square Solid Brass Grate with brass screws and PVC collar. Open surface area 2.5 square inches. 7.65 GPM.
914PB	5" Square Brass Grate w/PVC Collar	Polished Brass	10	1.21	15BR	
	Fits 4" Sewer and Drain Fittings, 3" Sewer and Drain Pipe, and 3" Triple Wall Pipe. ADA Compliant, see page 71.					

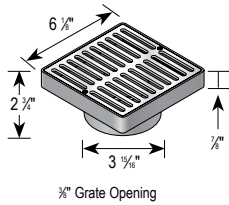

920B	6" Square Brass Grate w/Styrene Adapter	Satin Brass	8	1.65	15BR	6" Square Solid Brass Grate with brass-colored styrene low-profile adapter and brass screws. Open surface area 11.60 square inches. 35.49 GPM.
923PB	6" Square Brass Grate w/Styrene Adapter	Polished Brass	8	1.65	15BR	
	Fits 3" or 4" Sewer and Drain Pipe or Fittings, 3" or 4" Corrugated Pipe, and 3" or 4" Triple Wall Pipe. ADA Compliant, see page 71.					

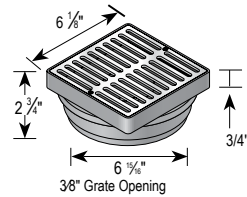

921B	6" Square Brass Grate w/Styrene Adapter	Satin Brass	8	1.71	15BR	6" Square Solid Brass Grate with brass-colored styrene low-profile adapter and brass screws. Open surface area 11.60 square inches. 35.49 GPM.
922PB	6" Square Brass Grate w/Styrene Adapter	Polished Brass	8	1.70	15BR	
	Fits Spee-D® Basin, 6" Sewer and Drain Pipe & Fittings. ADA Compliant, see page 71.					

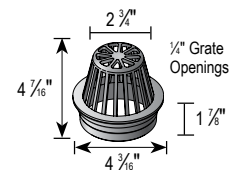

78B	4" Atrium Brass Grate	Brass	1	2.00	15BR	Open surface area 10.20 square inches. 31.20 GPM.
	Fits 4" Sewer and Drain Pipe & Fittings.					

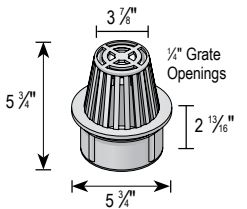

90B	6" Atrium Brass Grate	Brass	1	5.30	15BR	Open surface area 22.50 square inches. 68.83 GPM.
	Fits 6" Sewer and Drain Pipe & Fittings.					

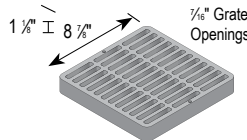

930B	9" Square Brass Grate	Brass	1	5.11	15BR	Open surface area 34.00 square inches. 104.01 GPM. Includes SS Screws.
	ADA Compliant, see page 71.					

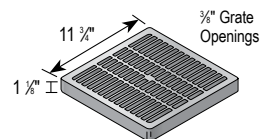



1230B	12" Square Brass Grate	Brass	1	9.24	15BR	Open surface area 42.87 square inches. 131.14 GPM. Includes SS Screws.
	ADA Compliant, see page 71.					

## Catch Basin Plastic & Metal Decorative Grates

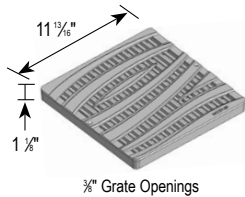
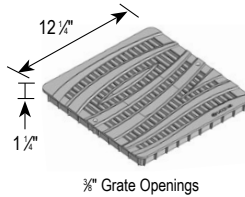
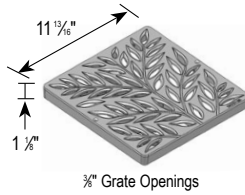
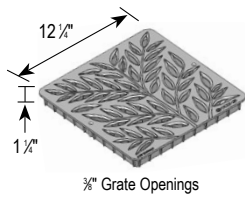
Fits 12" Catch Basins. Available in Botanical and Wave designs, in multiple colors or in cast iron. Plastic grates are "T-top" and overlap basin edge. Iron grates sit flush.



Part No.	Description	Color	Pkg. Qty.	Wt. Ea. (lbs.)	Product Class	Specifications
1218S	12" x 12" Square Botanical Grate	Sand	8	3.27	10ND	12" Square Structural Foam Polyolefin Botanical Grate with UV inhibitor. Open surface area 24.44 square inches. 74.77 GPM.
1218GR	12" x 12" Square Botanical Grate	Green	8	3.27	10ND	
1218GY	12" x 12" Square Botanical Grate	Gray	8	3.27	10ND	
1218	12" x 12" Square Botanical Grate	Black	8	3.27	10ND	
	Use Screw # 839, FH#6 x 1-3/4". ADA Compliant, see page 71.					

1218CI	12" x 12" Square Botanical Cast Iron Grate	Black*	1	12.67	10ND	12" Square Cast Iron Botanical Grate. Open surface area 24.44 square inches. 74.77 GPM. Class B load rated.
629	1/4-20 x 1-3/4" FH Phillips Screw	Metal	40	n/a	10ND	
	*Painted for shipping & display only; grate will form iron-oxide patina. ADA Compliant, see page 71.					

1224S	12" x 12" Square Wave Grate	Sand	8	2.68	10ND	12" Square Structural Foam Polyolefin Wave Grate with UV inhibitor. Open surface area 25.67 square inches. 78.53 GPM.
1224GR	12" x 12" Square Wave Grate	Green	8	2.68	10ND	
1224GY	12" x 12" Square Wave Grate	Gray	8	2.68	10ND	
1224	12" x 12" Square Wave Grate	Black	8	2.68	10ND	
	Use Screw # 839, FH#6 x 1-3/4". ADA Compliant, see page 71					

1224CI	12" x 12" Square Wave Cast Iron Grate	Black*	1	13.90	10ND	12" Square Cast Iron Wave Grate. Open surface area 25.60 square inches. 78.31 GPM. Class B load rated.
629	1/4-20 x 1-3/4" FH Phillips Screw	Metal	40	n/a	10ND	
	*Painted for shipping & display only; grate will form iron-oxide patina. ADA Compliant, see page 71					



### Slim Channel Plastic Decorative Grates

Excellent for light duty applications, including residential pools, concrete and paver patios, spas, walkways and paver landscapes.

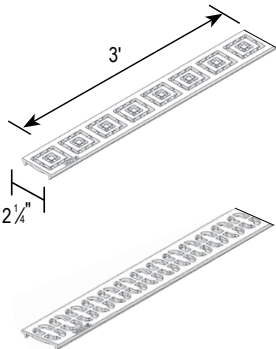

Part No.	Description	Color	Pkg. Qty.	Wt. Ea. (lbs.)	Product Class	Specifications
9251	3 ft. Slim Channel Grate Square	White	30 EA (90 LF)	0.36	25PF	3 ft Polypropylene Decorative Square Channel Grate with UV inhibitor. Open Surface Area 5.73 square inches per foot. 21.44 GPM per foot.
9252	3 ft. Slim Channel Grate Square	Sand	30 EA (90 LF)	0.36	25PF	
9253	3 ft. Slim Channel Grate Square	Gray	30 EA (90 LF)	0.36	25PF	
9261	3 ft. Slim Channel Grate Chain	White	30 EA (90 LF)	0.36	25PF	3 ft Polypropylene Decorative Chain Channel Grate with UV inhibitor. Open Surface Area 5.73 square inches per foot. 21.44 GPM per foot.
9262	3 ft. Slim Channel Grate Chain	Sand	30 EA (90 LF)	0.36	25PF	
9263	3 ft. Slim Channel Grate Chain	Gray	30 EA (90 LF)	0.36	25PF	
	ADA Compliant/Heel-proof, see page 71					

## Mini Channel Plastic & Metal Decorative Grates

Fits 500 Series Mini Channel. Available in Botanical and Wave designs, in multiple colors or in cast iron. Plastic grates are "T-top" and overlap basin edge. Iron grates sit flush.

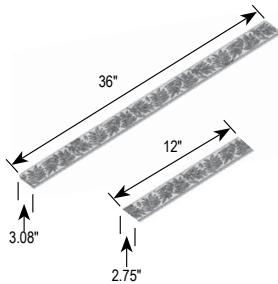

Part No.	Description	Color	Pkg. Qty.	Wt. Ea. (lbs.)	Product Class	Specifications
846	Stainless Steel Screws, FH #4 x 1"	Steel	40/Bag	0.10	25PF	3 ft. Structural Foam Polyolefin botanical pattern Channel Grate with UV inhibitor. Open surface area 5.44 square inches per foot. 16.64 GPM per foot.
554S	3' Botanical Channel Grate	Sand	16	0.89		
554GY	3' Botanical Channel Grate	Gray	16	0.89		
554	3' Botanical Channel Grate	Black	16	0.89		
554CI	1' Botanical Cast Iron Channel Grate	Black*	1	1.82		
529	Stainless Steel Screws, FH #4 x 5/8"	Steel	64/Bag	0.09	25PF	
	*Painted for shipping & display only; grate will form iron-oxide patina ADA Compliant, see page 71.					1 ft. Mini Channel botanical Cast Iron Channel Grate. Open surface area 5.39 square inches per foot. 16.49 GPM per foot. Class B load rated.

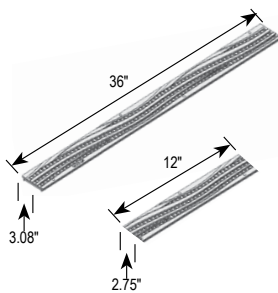

846	Stainless Steel Screws, FH #4 x 1"	Steel	40/Bag	0.10	25PF	3 ft. Structural Foam Polyolefin wave pattern Channel Grate with UV inhibitor. Open surface area 5.73 square inches per foot. 17.54 GPM per foot.
555S	3' Wave Channel Grate	Sand	16	0.88	25PF	
555GY	3' Wave Channel Grate	Gray	16	0.88		
555	3' Wave Channel Grate	Black	16	0.88		
555CI	1' Wave Cast Iron Channel Grate	Black*	1	1.30		
529	Stainless Steel Screws, FH #4 x 5/8"	Steel	64/Bag	0.09	25PF	
	*Painted for shipping & display only; grate will form iron-oxide patina ADA Compliant, see page 71					1 ft. Mini Channel Wave Cast Iron Channel Grate. Open surface area 4.11 square inches per foot. 12.56 GPM per foot. Class B load rated.

## Spee-D® Channel Plastic & Metal Decorative Grates

Fits Spee-D® Channel. Available in Botanical and Wave designs, in multiple colors or in cast iron. Plastic grates are "T-top" and overlap basin edge. Iron grates sit flush.

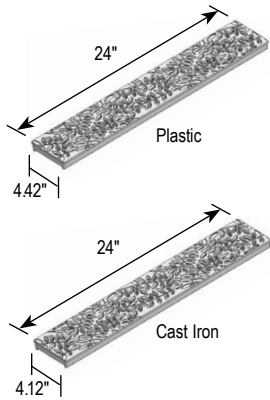

Part No.	Description	Color	Pkg. Qty.	Wt. Ea. (lbs.)	Product Class	Specifications
829	Stainless Steel Screws, FH #6 x 1-1/4"	Steel	40/ Bag	0.15	25PF	2 ft. Structural Foam Polyolefin decorative botanical Channel Grate with UV inhibitor. Open surface area 7.78 square inches per foot. 23.80 GPM per foot.  2 ft. Cast Iron decorative botanical Channel Grate. Open surface area 8.99 square inches per foot. 27.50 GPM per foot. Class B load rated.
252S	2' Channel Botanical Grate	Sand	24 ft.	1.74	25PF	
252GY	2' Channel Botanical Grate	Gray	24 ft.	1.74	25PF	
252	2' Channel Botanical Grate	Black	24 ft.	1.74	25PF	
252CI	2' Cast Iron Channel Botanical Grate	Black*	1 ft.	7.06	25PF	
229	Stainless Steel Screws, FH #8 x 1"	Steel	48/ Bag	0.06	25PF	
	*Painted for shipping & display only; grate will form iron-oxide patina ADA Compliant, see page 71					

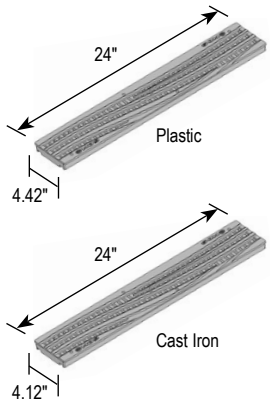

829	Stainless Steel Screws, FH #6 x 1-1/4"	Steel	40/ Bag	0.15	25PF	2 ft. Structural Foam Polyolefin decorative wave Channel Grate with UV inhibitor. Open surface area 7.78 square inches per foot. 23.80 GPM per foot.  2 ft. Cast Iron decorative wave Channel Grate. Open surface area 7.41 square inches per foot. 22.67 GPM per foot. Class B load rated.
253S	2' Channel Wave Grate	Sand	24 ft.	1.84	25PF	
253GY	2' Channel Wave Grate	Gray	24 ft.	1.84	25PF	
253	2' Channel Wave Grate	Black	24 ft.	1.84	25PF	
253CI	2' Cast Iron Channel Wave Grate	Black*	2 ft.	7.52	25PF	
229	Stainless Steel Screws, FH #8 x 1"	Steel	48/ Bag	0.06	25PF	
	*Painted for shipping & display only; grate will form iron-oxide patina ADA Compliant, see page 71					

## Dura Slope Metal Decorative Grates

Fits all Dura Slope channels. Available in 8 designs: Weave, Tile, Brick, Diamond, Slot, Kiaro, Via and Ville.  
Ductile iron material, rated Class D and ADA compliant.

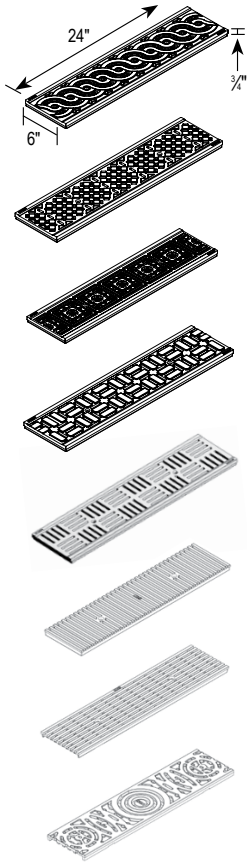

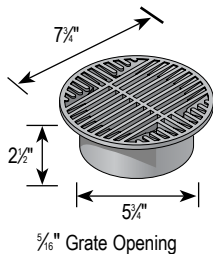
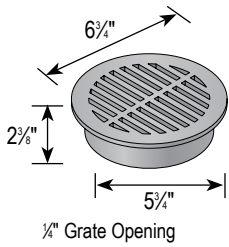
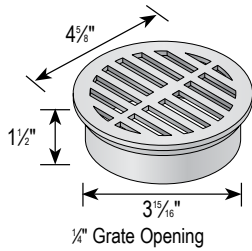
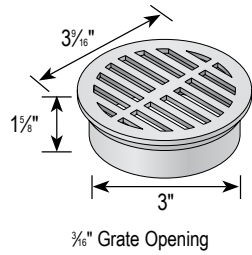

Part No.	Description	Color	Pkg. Qty.	Wt. Ea. (lbs.)	Product Class	Specifications
DS-601	Weave Pattern	Raw Iron	1	11.70	25DS	Weave: open area 7.92 square inches per foot; 24.3 GPM.
DS-602	Diamond Pattern	Raw Iron	1	14.30	25DS	Diamond: open area 9.25 square inches per foot; 28.3 GPM.
DS-603	Tile Pattern	Raw Iron	1	14.70	25DS	Tile: open area 11.93 square inches per foot; 33.6 GPM.
DS-604	Brick Pattern	Raw Iron	1	14.30	25DS	Brick: open area 9.72 square inches per foot; 29.8 GPM.
DS-609	Deco Slot	Raw Iron	1	11.70	25DS	Deco Slot: open area 17.46 square inches per foot; 53.5 GPM
DS-610-KIARO	Kiaro Slot	Ductile Iron	1	14.99	25DS	Kiaro Slot: open area 24.57 square inches per foot; 75.8 GPM.
DS-611-VIA	Via Slot	Ductile Iron	1	10.36	25DS	Via Slot: open area 22.9 square inches per foot; 70.1 GPM
DS-612-VILLE	Ville Pattern	Ductile Iron	1	11.68	25DS	Ville: open area 10.07 square inches per foot; 30.9 GPM
	Use with Dura Slope Drains (page 54). Decorative grates are made of ductile iron. Uncoated raw iron will develop a rust patina over time. ADA Compliant/Heel-proof, see page 71. Must be used with DS-200H frame to achieve Class D Load Rating.					

## Round Grates



Part No.	Description	Color	Pkg. Qty.	Wt. Ea. (lbs.)	Product Class	Specifications
14	3" Round Grate	Black	40	0.13	10ND	3" Round Structural Foam Polyolefin Grate with UV inhibitor. Open surface area 2.60 square inches. 7.95 GPM.
15	3" Round Grate	Gray	40	0.13	10ND	
16	3" Round Grate	Green	40	0.13	10ND	
16P	3" Round Grate	Purple	40	0.13	10ND	
16S	3" Round Grate	Sand	40	0.13	10ND	
	Fits 3" Sewer and Drain Pipe & Fittings, 3" Corrugated Pipe, and 3" Triple Wall Pipe. ADA Compliant/Heel-proof, see page 71.					

11	4" Round Grate	Black	25	0.17	10ND	4" Round Structural Foam Polyolefin Grate with UV inhibitor. Open surface area 3.85 square inches. 11.78 GPM.
12	4" Round Grate	Gray	25	0.17	10ND	
13	4" Round Grate	Green	25	0.17	10ND	
13P	4" Round Grate	Purple	25	0.17	10ND	
13S	4" Round Grate	Sand	25	0.17	10ND	
	Fits 4" Sewer and Drain Pipe & Fittings, 4" Corrugated Pipe, and 4" Triple Wall Pipe. ADA Compliant/Heel-proof, see page 71.					

40	6" Round Grate	Black	10	0.49	10ND	6" Round Structural Foam Polyolefin Grate with UV inhibitor. Open surface area 9.10 square inches. 27.84 GPM.
50	6" Round Grate	Green	10	0.49	10ND	
60	6" Round Grate	Gray	10	0.49	10ND	
60S	6" Round Grate	Sand	10	0.49	10ND	
	Fits Spee-D® Basin, 6" Sewer and Drain Pipe & Fittings and 6" Corrugated Pipe. ADA Compliant/Heel-proof, see page 71.					

10	8" Round Grate	Black	10	0.60	10ND	8" Round Structural Foam Polyolefin Grate with UV inhibitor. Open surface area 11.50 square inches. 35.18 GPM.
20	8" Round Grate	Green	10	0.60	10ND	
30	8" Round Grate	Gray	10	0.60	10ND	
30S	8" Round Grate	Sand	10	0.60	10ND	
	Fits Spee-D® Basin, 6" Sewer and Drain Pipe & Fittings and 6" Corrugated Pipe. ADA Compliant, see page 71.					

9P12	3 in. PVC Round Grate, Fits 3 in. Sewer & Drain Fittings	White	50	0.16	30pv	
9P11	4 in. PVC Round Grate, Fits 4 in. Sewer & Drain Fittings	White	25	0.36	30pv	

## Round Grates, continued

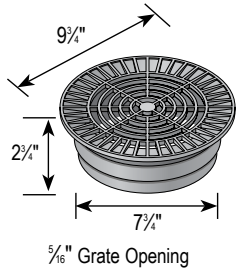

Part No.	Description	Color	Pkg. Qty.	Wt. Ea. (lbs.)	Product Class	Specifications
1040	10" Round Grate	Black	10	1.01	10ND	10" Round Structural Foam Polyolefin Grate with UV inhibitor. Open surface area 21.57 square inches. 65.99 GPM.
1050	10" Round Grate	Green	10	1.01	10ND	
1060	10" Round Grate	Gray	10	1.01	10ND	
1060S	10" Round Grate	Sand	10	1.01	10ND	
	Fits 8" Sewer and Drain Pipe & Fittings, 8" Corrugated Pipe. ADA Compliant, see page 71..					

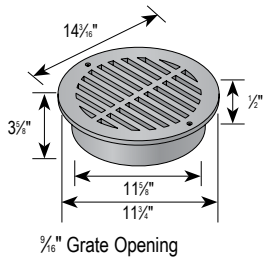

1240	12" Round Grate	Black	6	2.44	10ND	12" Round Structural Foam Polyolefin Grate with UV inhibitor. Open surface area 46.00 square inches. 140.72 GPM.
1250	12" Round Grate	Green	6	2.44	10ND	
1260	12" Round Grate	Gray	6	2.44	10ND	
	Fits 12" Sewer and Drain Pipe, 12" Corrugated Pipe. See page 71.					

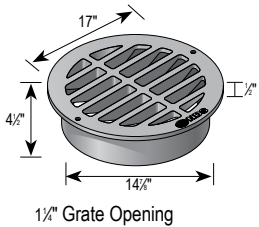

1511	15" Round Grate	Black	6	6.89	10ND	15" Round Structural Foam Polyolefin Grate with UV inhibitor. Open surface area 85.60 square inches. 261.86 GPM.
1512	15" Round Grate	Green	6	6.89	10ND	
	Fits 15" Sewer and Drain Fittings, 15" Corrugated Pipe. See page 71.					

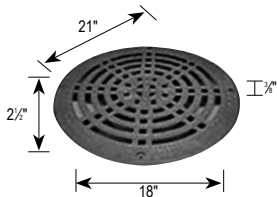

1801SDG	18" Round Grate	Green	1	7.50	28ND	Round Polypropylene Grate. Open surface area 75.55 square inches. 231.12 GPM. Includes lag bolts.
	Fits 18" Sewer and Drain Fittings, 18" Corrugated Pipe, includes Lag Bolts. See page 71.					

Atrium Grates

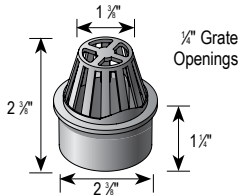

Part No.	Description	Color	Pkg. Qty.	Wt. Ea. (lbs.)	Product Class	Specifications
270	2" Atrium Grate	Gray	20	0.10	10ND	Flat-Top PVC Atrium Grate with UV inhibitor. Open surface area 4.00 square inches. 12.24 GPM.
Fits 2" Schedule 40 Fittings. Not for foot traffic.						

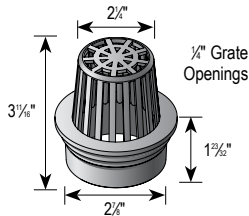

70	3" Atrium Grate	Green	20	0.16	10ND	Flat-Top Structural Foam Polyolefin Atrium Grate with UV inhibitor. Open surface area 9.40 square inches. 28.76 GPM.
72	3" Atrium Grate	Gray	20	0.16	10ND	
74	3" Atrium Grate	Black	20	0.16	10ND	
74S	3" Atrium Grate	Sand	20	0.16	10ND	
Fits 3" Sewer and Drain Pipe & Fittings, 3" Corrugated Pipe, and 3" Triple Wall Pipe.						

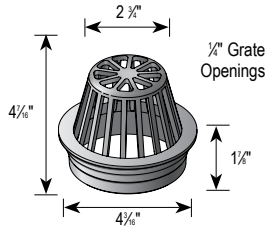

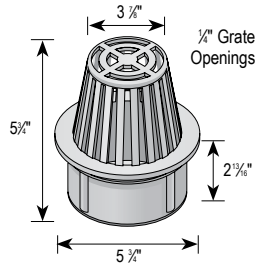

75	4" Atrium Grate	Green	20	0.21	10ND	Flat-Top Structural Foam Polyolefin Atrium Grate with UV inhibitor. Open surface area 17.00 square inches. 52.01 GPM.
76	4" Atrium Grate	Gray	20	0.21	10ND	
78	4" Atrium Grate	Black	20	0.21	10ND	
78S	4" Atrium Grate	Sand	20	0.21	10ND	
Fits 4" Sewer and Drain Pipe & Fittings, 4" Corrugated Pipe, and 4" Triple Wall Pipe.						



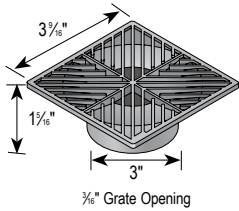

80	6" Atrium Grate	Green	10	0.62	10ND	Flat-Top Structural Foam Polyolefin Atrium Grate with UV inhibitor. Open surface area 28.40 square inches. 86.88 GPM.
81	6" Atrium Grate	Gray	10	0.62	10ND	
90	6" Atrium Grate	Black	10	0.62	10ND	
90S	6" Atrium Grate	Sand	10	0.62	10ND	
Fits Spee-D® Basin, 6" Sewer and Drain Pipe & Fittings, 6" Corrugated Pipe.						

## Square Grates

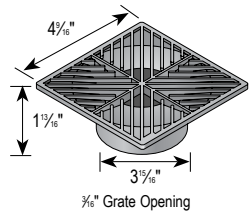

Part No.	Description	Color	Pkg. Qty.	Wt. Ea. (lbs.)	Product Class	Specifications
1	4" Square Grate	Green	40	0.11	10ND	4" Square Structural Foam Polyolefin Grate with diagonally converging pattern with UV inhibitor. Open surface area 3.45 square inches. 10.55 GPM.
2	4" Square Grate	Black	40	0.11	10ND	
3	4" Square Grate	Gray	40	0.11	10ND	
	Fits 3" Sewer and Drain Pipe & Fittings, 3" Corrugated Pipe, and 3" Triple Wall Pipe. ADA Compliant/Heel-proof, see page 71.					



7	5" Square Grate	Green	25	0.20	10ND	5" Square Structural Foam Polyolefin Grate with diagonally converging pattern with UV inhibitor. Open surface area 4.25 square inches. 13.00 GPM.
8	5" Square Grate	Black	25	0.20	10ND	
9	5" Square Grate	Gray	25	0.20	10ND	
	Fits 4" Sewer and Drain Pipe & Fittings, 4" Corrugated Pipe, and 4" Triple Wall Pipe. ADA Compliant/Heel-proof, see page 71.					

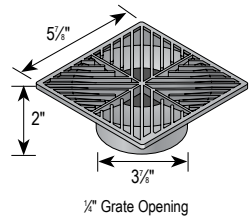

4	6" Square Grate	Black	10	0.40	10ND	6" Square Structural Foam Polyolefin Grate with diagonally converging pattern with UV inhibitor. Open surface area 10.40 square inches. 31.81 GPM.
5	6" Square Grate	Green	10	0.40	10ND	
6	6" Square Grate	Gray	10	0.40	10ND	
06S	6" Square Grate	Sand	10	0.40	10ND	
	Fits 3" or 4" Sewer and Drain Pipe, 3" or 4" Corrugated Pipe, and 3" or 4" Triple Wall Pipe. ADA Compliant/Heel-proof, see page 71.					

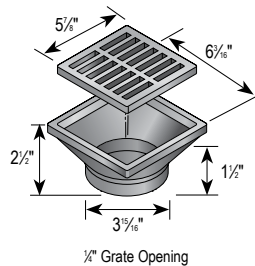

640	6" x 6" x 4" Square Grate & Adapter	Black	8	0.83	10ND	6"x6" Low-Profile Adapter and Structural Foam Polyolefin Removable Grate with UV inhibitor and stainless steel screws. Open surface area 14.44 square inches. 44.17 GPM.
641	6" x 6" x 4" Square Grate & Adapter	Green	8	0.83	10ND	
642	6" x 6" x 4" Square Grate & Adapter	Gray	8	0.83	10ND	
	Fits 3" or 4" Sewer and Drain Pipe & Fittings, 3" or 4" Corrugated Pipe, and 3" or 4" Triple Wall Pipe. ADA Compliant/Heel-proof, see page 71.					



Square Grates, continued

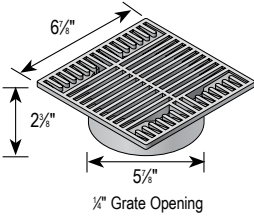

Part No.	Description	Color	Pkg. Qty.	Wt. Ea. (lbs.)	Product Class	Specifications
771	7" Square Grate	Black	10	0.65	10ND	7" Square Structural Foam Polyolefin Grate with UV inhibitor. Open surface area 13.60 square inches. 41.60 GPM.
772	7" Square Grate	Green	10	0.65	10ND	
773	7" Square Grate	Gray	10	0.65	10ND	
773S	7" Square Grate	Sand	10	0.65	10ND	
	Fits Spee-D® Basin, 6" Sewer and Drain Pipe & Fittings, 6" Corrugated Pipe. ADA Compliant/Heel-proof, see page 71.					

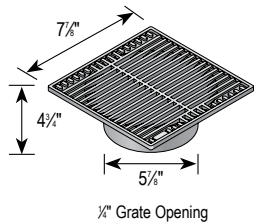

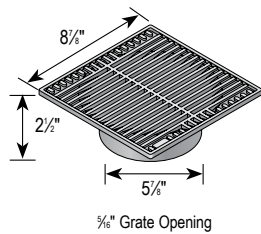

881	8" Square Grate	Black	10	0.79	10ND	8" Square Structural Foam Polyolefin Grate with UV inhibitor. Open surface area 17.16 square inches. 52.49 GPM.
882	8" Square Grate	Green	10	0.79	10ND	
883S	8" Square Grate	Sand	10	0.79	10ND	
	Fits Spee-D® Basin, 6" Sewer and Drain Pipe & Fittings, 6" Corrugated Pipe and DWV Pipe. ADA Compliant/Heel-proof, see page 71.					



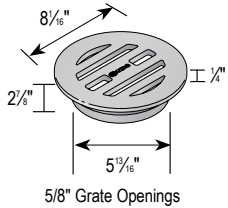

950	9" Square Grate	Green	10	1.11	10ND	9" Square Structural Foam Polyolefin Grate with UV inhibitor. Open surface area 28.40 square inches. 86.88 GPM.
960	9" Square Grate	Gray	10	1.11	10ND	
970	9" Square Grate	Black	10	1.11	10ND	
980S	9" Square Grate	Sand	10	1.11	10ND	
	Fits Spee-D® Basin, 6" Sewer and Drain Pipe & Fittings, 6" Corrugated Pipe. ADA Compliant, see page 71.					

## Duracast™ In-Line Grates

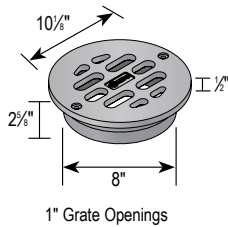

Part No.	Description	Color	Pkg. Qty.	Wt. Ea. (lbs.)	Product Class	Specifications
D6	6" Round Grate	Black*	1	7.30	10ND	6" Round Heavy-Duty Ductile Grate with Black Paint. Open surface area 7.05 square inches. 21.57 GPM. H-20 load rating.
 <p>Fits 6" Corrugated and Sewer and Drain Pipe. D6 is not a custom grate and qualifies for normal NDS freight terms. Fits SPEE-D® Basin.</p> <p>*Painted for shipping &amp; display only; grate will form iron-oxide patina See page 71.</p>						



D8	8" Round Grate	Black*	1	14.59	10ND	8" Round Heavy-Duty Ductile Iron Grate with Black Paint. Open surface area 13.98 square inches. 42.77 GPM. Bolt holes for added security. H-20 load rating.
 <p>Fits 8" Corrugated and Sewer and Drain Pipe. D8 is not a custom grate and qualifies for normal NDS freight terms.</p> <p>*Painted for shipping &amp; display only; grate will form iron-oxide patina ADA Compliant, see page 71.</p>						

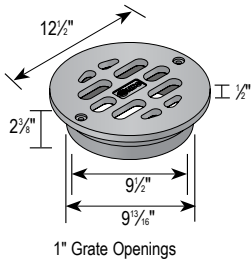

D10	10" Round Grate	Black*	1	20.60	10ND	10" Round Heavy-Duty Ductile Iron Grate with Black Paint. Open surface area 26.82 square inches. 82.05 GPM. Bolt holes for added security. H-20 load rating.
 <p>Fits 10" Corrugated and Sewer and Drain Pipe. D10 is not a custom grate and qualifies for normal NDS freight terms.</p> <p>*Painted for shipping &amp; display only; grate will form iron-oxide patina ADA Compliant, see page 71..</p>						

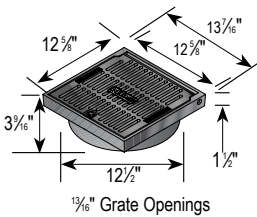

D12H-WO	12" Square Hinged Cast Iron Grate	Black*	1	48.00	10ND	D12H-WO: H-20 load rating. Open surface area 48.30 square inches. 147.76 GPM
D12	12" Round Grate	Black*	1	16.00	10ND	12" Round Heavy-Duty Ductile Iron Grate with Black Paint Open surface area 55.16 square inches. 169.74 GPM. H-20 load rating

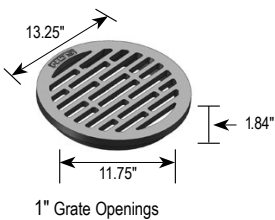

 <p>Fits 12" Corrugated and Sewer and Drain Pipe.</p> <p>*Painted for shipping &amp; display only; grate will form iron-oxide patina ADA Compliant, see page 71..</p>						
--	--	--	--	--	--	--

## Index, Drainage Products

Part No.	Page	Part No.	Page	Part No.	Page	Part No.	Page	Part No.	Page
1	32	201	9	900MTLKIT	10	1213	14	2413	17
2	32	229	27	900SKIT	10	1215	14	2415	17
3	32	250	9	905PB	22	1216	12	2418	17
3C05	6, 21	252	27	906PB	22	1218	13, 24	9251	25
3C06	6, 21	252CI	27	907PC	22	1218CI	13, 24	9252	25
3p02	21	252GY	27	908PC	22	1218GR	13, 24	9253	25
4	32	252S	27	909B	22	1218GY	13, 24	9261	25
4C06	6, 21	253	27	910B	22	1218S	13, 24	9262	25
4C07	6, 21	253CI	27	913	11	1220	14	9263	25
4p02	21	253GY	27	913B	23	1221	14	D6	34
5	32	253S	27	914PB	23	1222	14	D8	34
6	32	270	31	915	11	1224	14, 24	D10	34
6C06	6, 21	300	9	915SC	22	1224CI	14, 24	D12	34
6C07	6, 21	321	19	916	10	1224GR	14, 24	D12H-WO	34
6P02	21	350	9	917SC	22	1224GY	14, 24	DS-601	28
06S	32	351	21	918B	22	1224S	14, 24	DS-602	28
7	32	420	19	919PB	22	1225	12	DS-603	28
8	32	421	19	920B	23	1230	14	DS-604	28
9	32	430	19	921B	23	1230B	13, 23	DS-609	28
9P11	29	451	21	922PB	23	1240	30	DS-610-KIARO	28
9P12	29	529	26	923PB	23	1241	19	DS-611-VIA	28
10	29	552B	22	930	11	1243	18	DS-612-VILLE	28
11	29	553PB	22	930B	11, 23	1245	18	EZ-0701A	6
12	29	554	26	930GRKIT	11	1250	30	EZ-0701F	6
13	29	554CI	26	931	11	1260	30	EZ-1001A	6
13P	29	554GY	26	932	11	1266	18	EZ-1001F	6
13S	29	554S	26	950	33	1280	13	EZ-1501A	6
14	29	555	26	960	33	1290	13	EZ-1501F	6
15	29	555CI	26	970	33	1511	30	FWAS24CWH	8
16	29	555GY	26	980	10	1512	30	FWAS24WH	8
16P	29	555S	26	980S	33	1800	15	FWBP24	8
16S	29	620	20	981	10	1801SDG	30	FWFF67	8
20	29	624	20	990	10	1804	15	FWSD69	8
30	29	625	20	991	10	1810	16	FWSPS3WH	8
30S	29	629	13, 14, 24	999	10	1811	16	SC-1820-C-O	7
40	29	640	32	999S	10	1812	16	SC-1820-E-O	7
50	29	641	32	1040	30	1813	16	SC-1820-M-O	7
60	29	642	32	1050	30	1815	16	SC-1820-S-O	7
60S	29	651	21	1060	30	1816	15	SC-2412P	7
70	31	771	33	1060S	30	1830	16	SC-3020P	7
72	31	772	33	1200	12	1881	15	SC-3475-C-O	7
74	31	773	33	1200BLKIT	12	1882	15	SC-3475-E-O	7
74S	31	773S	33	1200DSG	13	1882BLKIT	15	SC-3475-M-O	7
75	31	829	27	1200FF	12	1882GRKIT	15	SC-3475-S-O	7
76	31	846	26	1200GRKIT	12	1884	15	SC-44105-C-O	7
78	31	881	33	1200KITDISP	12	1888	18	SC-44105-E-O	7
78B	23	882	33	1200MTLKIT	12	1889	18	SC-44105-M-O	7
78S	31	883S	33	1200NGBKIT	12	1890	16	SC-44105-S-O	7
80	31	900	10	1200SKIT	12	1891	15	SC-FL-10	7
81	31	900-4	10	1203	12	2400	17	SC-NWFF-500	7
90	31	900BLKIT	10	1204	12	2400BLKIT	17	SC-ST	7
90B	23	900DSG	10	1206	18	2400GRKIT	17	SC-WFF-75	7
90S	31	900DSGKIT	10	1210	13	2404	17		
101	9	900FF	10	1211	13	2410	17, 18		
101GRKIT	9	900GRKIT	10	1212	13	2411	17		
101R	9	900KITDISP	10	1212S	13	2412	17		

For Drainage Product Information, Refer to Technical Specification documents at [ndspro.com/specifications](https://ndspro.com/specifications)



# Channel Drains

NDS offers a wide range of channel and trench drains suitable for any application. These long and narrow drains, intercept, collect, and convey water runoff to drain pipes, reducing runoff on property and standing water on hardscapes that can lead to slip hazards, pest breeding grounds, and erosion.

## Product Applications



### Residential

NDS offers channel drain and grate solutions ideal for pool decks and patios, walkways and driveways.

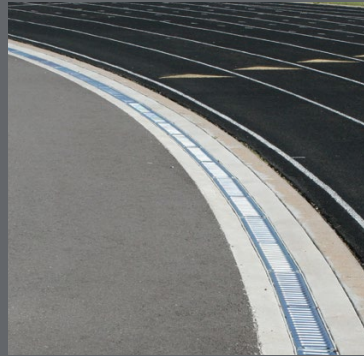

### Commercial

A variety of sizes and solutions ideal for any commercial application including plazas, courtyards, parking lots and sports facilities.



### Heavy-Duty

For installations requiring higher-load bearing capabilities, NDS has solutions for factory floors, loading docks, washdown areas and warehouses.

## Channel Grate Materials and Styles

Our grates are available in a wide variety of styles, materials, colors and finishes.

### Materials:

Plastic, Iron, Polished Brass, Satin Brass, Galvanized Steel & Stainless Steel

Plastic



Iron



Polished & Satin Brass



Galvanized Steel



Stainless Steel



Botanical

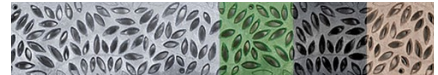

Wave

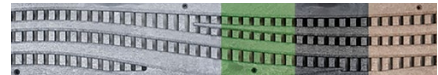

Weave



Diamond



Brick



Tile



Deco Slot



Slotted



Square



Chain



We put water in its place™

## FILCOTEN® Channel Drain

FILCOTEN® by NDS® combines smart engineering and smart materials to provide a superior trench drain suitable for handling a high-load capacity.

4 in., 8 in. and 12 in. widths, sloped and neutral.

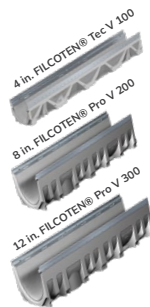

## Dura Slope™ Trench Drain

NDS Dura Slope™ is a high-quality trench drain system ideal for the interception and collection of surface runoff, including driveways, parking areas, warehouses, loading docks, pools, wash down areas. This pre-sloped and neutral trench is great for residential, commercial, industrial and municipal drainage needs.

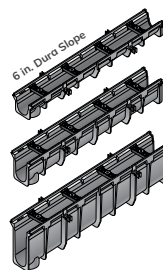

## Pro Series Channel Drain

NDS Pro Series™ is a lightweight channel drain system with interlocking joints and a modular design, so systems are flexible and connections are made quickly and easily. Load Rated Up to Class C with appropriate grate. For Residential and Commercial applications.

3 in., 5 in., 8 in. and 12 in. widths.

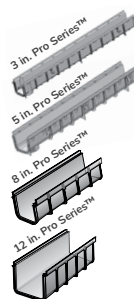

## Profile Channel Drain

Unique patented flying buttress design provides load-bearing support. Available in four sizes. Spee-D® for driveways, large decks and commercial areas; Mini for landscapes, pools or decks; Slim for residential pools, spas and walkways and Micro for residential pools and spas.

1 in., 3 in. and 4 in. widths.

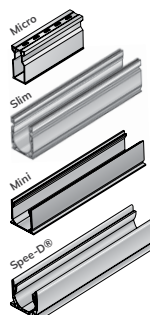

## Profile Channel Drains

### Micro Channel™ Drains

Excellent performance at lowest possible cost. Designed for residential applications including swimming pools, spas and patios. Unique design features grate openings parallel to channel length and recessed grate for strength and effective runoff capture.

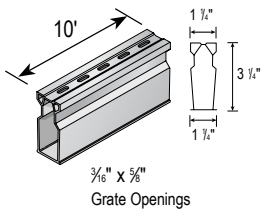

Part No.	Description	Color	Pkg. Qty.	Weight Ea. (lbs.)	Product Class	Specificationa
8001	10' Long Micro Channel	White	100 ft.	5.00	25PF	10 ft. Micro Channel with Recessed Reinforced Grate Area, Parallel Drain Slots with UV inhibitor. Open surface area 1.00 square inch per linear foot. 3.06 GPM per foot. PVC.
8002	10' Long Micro Channel	Sand	100 ft.	5.00	25PF	
8003	10' Long Micro Channel	Gray	100 ft.	5.00	25PF	
	Includes 1 coupling. ADA Compliant/Heel-proof, see page 71.					

All Micro Channel Drains are Made in the USA

Micro Channel™ Accessories

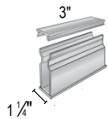
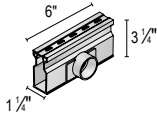
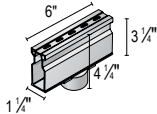
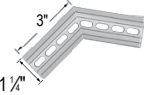
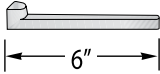

Part No.	Description	Color	Pkg. Qty.	Weight Ea. (lbs.)	Product Class
230	6" Channel Installation Stake	Gray	24	0.04	25PF
8301	Micro Channel 45° Elbow*	White	5	0.30	25PF
8302	Micro Channel 45° Elbow*	Sand	5	0.30	25PF
8303	Micro Channel 45° Elbow*	Gray	5	0.30	25PF
8381	Micro Channel 90° Elbow*	White	5	0.40	25PF
8382	Micro Channel 90° Elbow*	Sand	5	0.40	25PF
8383	Micro Channel 90° Elbow*	Gray	5	0.40	25PF
8461	Micro 1/2" Sch. 40 Spigot End Outlet*	White	10	0.10	25PF
8462	Micro 1/2" Sch. 40 Spigot End Outlet*	Sand	10	0.10	25PF
8463	Micro 1/2" Sch. 40 Spigot End Outlet*	Gray	10	0.10	25PF
8471	Micro End Plug	White	20	0.05	25PF
8472	Micro End Plug	Sand	20	0.05	25PF
8473	Micro End Plug	Gray	20	0.05	25PF
8481	Micro Channel Couplings only Fits inside channel	White	20	0.10	25PF
8501	Micro 1/2" Sch. 40 Spigot Bottom Outlet*	White	10	0.35	25PF
8502	Micro 1/2" Sch. 40 Spigot Bottom Outlet*	Sand	10	0.35	25PF
8503	Micro 1/2" Sch. 40 Spigot Bottom Outlet*	Gray	10	0.35	25PF
8511	Micro 1/2" Sch. 40 Spigot Side Outlet	White	10	0.35	25PF
8512	Micro 1/2" Sch. 40 Spigot Side Outlet	Sand	10	0.35	25PF
8513	Micro 1/2" Sch. 40 Spigot Side Outlet	Gray	10	0.35	25PF
8601	Micro Hold-Down Clips Use with Channel Stakes to hold channel in place	White	20	0.10	25PF
8651	Micro Channel Cleanout*	White	10	0.30	25PF
8652	Micro Channel Cleanout*	Sand	10	0.30	25PF
8653	Micro Channel Cleanout*	Gray	10	0.30	25PF

\*Requires 8481 coupling

## Slim Channel Drains

Excellent for light duty applications, including residential pools, concrete and paver patios, spas, walkways and paver landscapes.

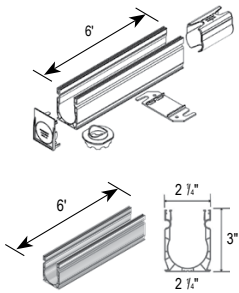

Part No.	Description	Color	Pkg. Qty.	Weight Ea. (lbs.)	Product Class	Specifications
9206SKIT	6 ft. Slim Channel Kits with sand plastic grates	Sand	15 ea. (90 LF)	4.2	25PF	2.25" wide Channel Drain Kits & Assemblies End & bottom outlets fit 1-1/2" Schedule 40 pipe PVC Channel with UV inhibitor See related specifications for 9241, 9242 & 9243 plastic slotted grates
9206GKIT	6 ft. Slim Channel Kits with gray plastic grates	Gray	15 ea. (90 LF)	4.2	25PF	
Kits include 6 ft. channel, 2 slotted grates, 2 end caps/outlets, 2 anchor clips, 1 coupling & 1 bottom outlet						
9209WHITE	9 ft. Slim Channel & Grate Assembly	White	10 ea. (90 LF)	5.58	25PF	
9209SAND	9 ft. Slim Channel & Grate Assembly	Sand	10 ea. (90 LF)	5.58	25PF	
9209GRAY	9 ft. Slim Channel & Grate Assembly	Gray	10 ea. (90 LF)	5.58	25PF	
Assemblies include 9 ft. channel and 3 slotted grates						
9206	6 ft. Slim Channel	Black	15 ea. (90 LF)	3.00	25PF	
9209	9 ft. Slim Channel	Black	10 ea. (90 LF)	4.5	25PF	
	See page 71.					
9241	3 ft. Slim Channel Grate	White	30 ea. (90 LF)	0.36	25PF	3 ft polypropylene channel grate with UV inhibitor. Open Surface Area 7.01 square inches per foot. 21.44 GPM per foot.
9242	3 ft. Slim Channel Grate	Sand	30 ea. (90 LF)	0.36	25PF	
9243	3 ft. Slim Channel Grate	Gray	30 ea. (90 LF)	0.36	25PF	
9251	3 ft. Slim Channel Grate Square	White	30 ea. (90 LF)	0.36	25PF	3 ft Polypropylene Decorative Square Channel Grate with UV inhibitor. Open Surface Area 5.73 square inches per foot. 21.44 GPM per foot.
9252	3 ft. Slim Channel Grate Square	Sand	30 ea. (90 LF)	0.36	25PF	
9253	3 ft. Slim Channel Grate Square	Gray	30 ea. (90 LF)	0.36	25PF	
9261	3 ft. Slim Channel Grate Chain	White	30 ea. (90 LF)	0.36	25PF	3 ft Polypropylene Decorative Chain Channel Grate with UV inhibitor. Open Surface Area 5.73 square inches per foot. 21.44 GPM per foot.
9262	3 ft. Slim Channel Grate Chain	Sand	30 ea. (90 LF)	0.36	25PF	
9263	3 ft. Slim Channel Grate Chain	Gray	30 ea. (90 LF)	0.36	25PF	
	See page 71.					

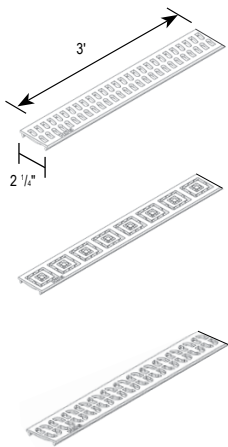



Slim Channel Accessories

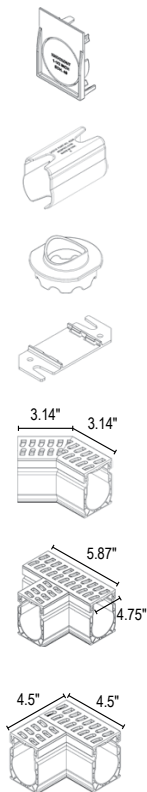

Part No.	Description	Color	Pkg. Qty.	Weight Ea. (lbs.)	Product Class	Specificationa
9247	Slim Channel End Cap/Outlet	Black	20 EA	0.04	25PF	End & bottom outlets fit 1-1/2" Schedule 40 pipe
9248	Slim Channel Coupling*	Black	20 EA	0.08	25PF	
9250	Slim Channel Bottom Outlet	Black	10 EA	0.04	25PF	
9270	Slim Channel Anchor Clip	Black	20 EA	0.04	25PF	
9301	Slim Channel Fab 45	White	1 EA	0.29	25PF	
9302	Slim Channel Fab 45	Sand	1 EA	0.29	25PF	
9303	Slim Channel Fab 45	Gray	1 EA	0.29	25PF	
9371	Slim Channel Fab Tee	White	1 EA	0.41	25PF	
9372	Slim Channel Fab Tee	Sand	1 EA	0.41	25PF	
9373	Slim Channel Fab Tee	Gray	1 EA	0.41	25PF	
9381	Slim Channel Fab 90	White	1 EA	0.35	25PF	
9382	Slim Channel Fab 90	Sand	1 EA	0.35	25PF	
9383	Slim Channel Fab 90	Gray	1 EA	0.35	25PF	

\*Slim channel fittings require slim channel couplings

## Mini Channel™ Drains

Excellent for light-duty applications including residential pools, concrete and paver patios, spas and tennis courts.

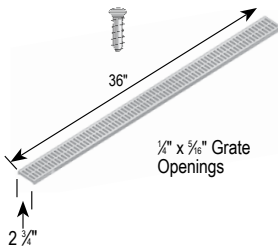

Part No.	Description	Color	Pkg. Qty.	Weight Ea. (lbs.)	Product Class	Specifications
529	Stainless Steel Screws, FH #4 x 5/8"	Steel	64/Bag	0.10	25PF	3 ft. Structural Foam Polyolefin Plastic Channel Grate with UV inhibitor. Open surface area 9.90 square inches per foot. 30.29 GPM per foot.
540	3' Channel Grate	White	48 ft.	0.66	25PF	
541	3' Channel Grate	Gray	48 ft.	0.66	25PF	
542	3' Channel Grate	Green	48 ft.	0.66	25PF	
543	3' Channel Grate	Black	48 ft.	0.66	25PF	
544	3' Channel Grate	Sand	48 ft.	0.66	25PF	
551	3' Channel Grate	Brick Red	48 ft.	0.66	25PF	
	Requires 4 screws per Grate. ADA Compliant/Heel-proof, see page 71.					

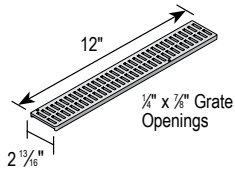

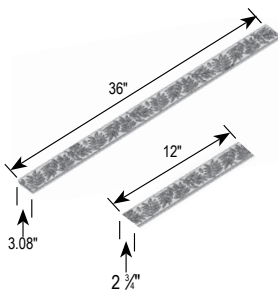

552B	1' Brass Channel Grate	Satin Brass	12	1.25	25PF	1 ft. Mini Channel Solid Brass Grate with brass screws. Open surface area 9.20 square inches per foot. 28.14 GPM per foot.
553PB	1' Brass Channel Grate	Polished Brass	12	1.25	25PF	
	Fits #500 Mini Channel, see page 43. ADA Compliant/Heel-proof, see page 71.					

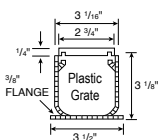
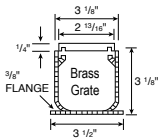
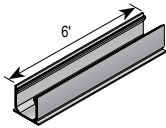
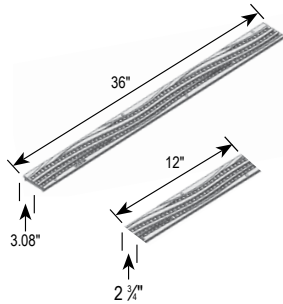

846	Stainless Steel Screws, FH #4 x 1"	Steel	40/Bag	0.10	25PF	3 ft. Structural Foam Polyolefin Plastic botanical pattern Channel Grate with UV inhibitor. Open surface area 5.44 square inches per foot. 16.64 GPM per foot.
554S	3' Botanical Channel Grate	Sand	16	0.89	25PF	
554GY	3' Botanical Channel Grate	Gray	16	0.89	25PF	
554	3' Botanical Channel Grate	Black	16	0.89	25PF	1 ft. Mini Channel botanical Cast Iron Channel Grate. Open surface area 5.39 square inches per foot. 16.49 GPM per foot. Class B load rated.
554CI	1' Botanical Cast Iron Channel Grate	Black*	1	1.82	25PF	
	Fits #500 Mini Channel, see page 43. ADA Compliant, see page 71. *Painted for shipping & display only; grate will form iron-oxide patina					

Mini Channel™ Drains



Part No.	Description	Color	Pkg. Qty.	Weight Ea. (lbs.)	Product Class	Specifications
846	Stainless Steel Screws, FH #4 x 1"	Steel	40/Bag	0.10	25PF	3 ft. Structural Foam Polyolefin Plastic wave pattern Channel Grate with UV inhibitor. Open surface area 5.73 square inches per foot. 17.54 GPM per foot. 1 ft. Mini Channel Wave Cast Iron Channel Grate. Open surface area 4.11 square inches per foot. 12.56 GPM per foot. Class B load rated.
555S	3' Wave Channel Grate	Sand	16	0.88	25PF	
555GY	3' Wave Channel Grate	Gray	16	0.88	25PF	
555	3' Wave Channel Grate	Black	16	0.88	25PF	
555CI	1' Wave Cast Iron Channel Grate	Black*	1	1.30	25PF	
	Fits #500 Mini Channel, see below. ADA Compliant, see page 71. *Painted for shipping & display only; grate will form iron-oxide patina					

500	6' Mini Channel Drain	Gray	48 ft.	3.26	25PF	6 ft. PVC Mini Channel Drain with inverse flying-buttress design, bottom flange, patented honeycomb reinforced walls and UV inhibitor.
500S	6' Mini Channel Drain	Sand	48 ft.	3.26	25PF	
Grate should be recessed 1/8" below finish grade in non-traffic applications. Grate should be recessed 1/4" in traffic applications.						

## Mini Channel™ Accessories

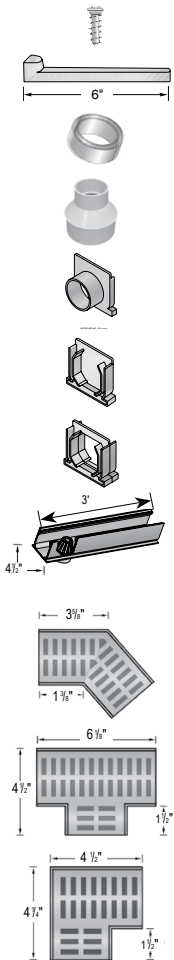

Part No.	Description	Color	Pkg. Qty.	Weight Ea. (lbs.)	Product Class
529	Stainless Steel Screws, FH #4 x 5/8"	Steel	64/Bag	0.10	25PF
230	6" Channel Installation Stake	Gray	24	0.04	25PF
532	Adapter Bushing for Mini Channel 2" Bottom & End Outlet to 3" S&D Fittings	White	20	0.14	30PV
533	Adapter for Mini Channel 2" Bottom & End Outlet to 4" S&D Fittings	White	20	0.34	30PV
546	Mini Channel End Outlet to 2" Sch. 40 Pipe Fittings	Gray	10	0.15	25PF
546S	Mini Channel End Outlet to 2" Sch. 40 Pipe Fittings	Sand	10	0.15	25PF
547	Mini Channel End Cap	Gray	20	0.12	25PF
547S	Mini Channel End Cap	Sand	20	0.12	25PF
548	Mini Channel Coupling	Gray	20	0.12	25PF
548S	Mini Channel Coupling	Sand	20	0.12	25PF
550	3' Mini Channel Drain with Atrium Strainer & Bottom Outlet to 2" Sch. 40 Pipe Fittings	Gray	6	2.17	25PF
5300	Fabricated 45° Elbow with Grate	Gray	1	0.40	25PF
5303	Fabricated 45° Elbow with Grate	Sand	1	0.40	25PF
5370	Fabricated Tee with Grate	Gray	1	0.50	25PF
5380	Fabricated 90° Elbow with Grate	Gray	1	0.40	25PF
5383	Fabricated 90° Elbow with Grate	Sand	1	0.40	25PF

### Spee-D® Channel Drains

Ideal for commercial as well as residential applications. Effective in everything from patios to light vehicular traffic areas

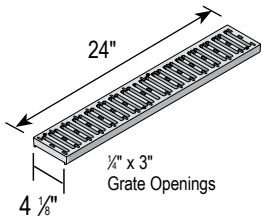

Part No.	Description	Color	Pkg. Qty.	Weight Ea. (lbs.)	Product Class	Specifications
229	Stainless Steel Screws, FH #8 X 1" for Spee-D Channel Plastic Slotted Grates	Steel	48/Bag	0.06	25PF	2 ft. Structural Foam Polyolefin Plastic Secured Channel Grate with UV inhibitor. Open surface area 16.76 square inches per foot. 51.27 GPM per foot.
240	2' Channel Slotted Grate	White	24 ft.	1.33	25PF	
241	2' Channel Slotted Grate	Gray	24 ft.	1.33	25PF	
242	2' Channel Slotted Grate	Green	24 ft.	1.33	25PF	
243	2' Channel Slotted Grate	Black	24 ft.	1.33	25PF	
244	2' Channel Slotted Grate	Sand	24 ft.	1.33	25PF	2 ft. Galvanized Steel Channel Grate. Open surface area 15.49 square inches per foot. 47.39 GPM per foot.
251	2' Channel Slotted Grate	Brick Red	24 ft.	1.42	25PF	
254	2' Galvanized Steel Channel Grate	Galv. Steel	24 ft.	1.90	25PF	
	ADA Compliant, see page 71.					

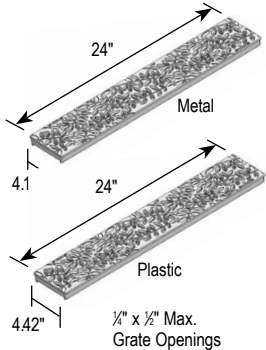

829	Stainless Steel Screws, FH #6 X 1-1/4" for Spee-D Channel Decorative Plastic Grates	Steel	40/Bag	0.15	25PF	2 ft. Structural Foam Polyolefin Plastic decorative botanical Channel Grate with UV inhibitor. Open surface area 7.78 square inches per foot. 23.80 GPM per foot.
252S	2' Channel Botanical Grate	Sand	24 ft.	1.74	25PF	
252GY	2' Channel Botanical Grate	Gray	24 ft.	1.74	25PF	2 ft. Cast Iron decorative botanical Channel Grate. Open surface area 8.99 square inches per foot. 27.50 GPM per foot. Class B load rated.
252	2' Channel Botanical Grate	Black	24 ft.	1.74	25PF	
252CI	2' Cast Iron Channel Botanical Grate	Black*	2 ft.	7.06	25PF	
229	Stainless Steel Screws, FH #8 x 1" for Spee-D Channel Decorative Iron Grates	Steel	48	0.06	25PF	
	See page 71. ADA Compliant, see page 71. *Painted for shipping & display only; grate will form iron-oxide patina					

## Spee-D® Channel Drains

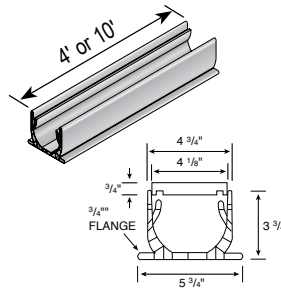
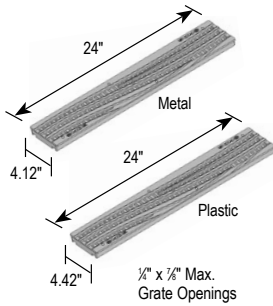

Part No.	Description	Color	Pkg. Qty.	Weight Ea. (lbs.)	Product Class	Specifications
829	Stainless Steel Screws, FH #6 X 1-1/4" for Spee-D Channel Decorative Plastic Grates	Steel	40/Bag	0.15	25PF	2 ft. Structural Foam Polyolefin Plastic decorative wave Channel Grate with UV inhibitor. Open surface area 7.78 square inches per foot. 23.80 GPM per foot.
253S	2' Channel Wave Grate	Sand	24 ft.	1.84	25PF	
253GY	2' Channel Wave Grate	Gray	24 ft.	1.84	25PF	
253	2' Channel Wave Grate	Black	24 ft.	1.84	25PF	
253CI	2' Cast Iron Channel Wave Grate	Black*	2 ft.	7.52	25PF	
229	Stainless Steel Screws, FH #8 x 1" for Spee-D Channel Decorative Iron Grates	Steel	48	0.06	25PF	2 ft. Cast Iron decorative wave Channel Grate. Open surface area 7.41 square inches per foot. 22.67 GPM per foot. Class B load rated.
	ADA Compliant, see page 71. *Painted for shipping & display only; grate will form iron-oxide patina					

400	4' Spee-D Channel Drain	Gray	24 ft.	4.83	25PF	PVC Channel Drain with Inverse Flying Buttress design, bottom flange, patented honeycomb reinforced walls and UV inhibitor.
400-10	10' Spee-D Channel Drain	Gray	60 ft.	11.00	25PF	
400-10WH	10' Spee-D Channel Drain Assembly with pre-fastened Gray Plastic Grates	Gray	60 ft.	17.5	25PF	
400-10MTL	10' Spee-D Channel Drain Assembly with pre-fastened Galvanized Steel Grates	Galvanized Steel	40 ft.	20.5	25PF	
	Grate should be recessed 1/8" below finish grade in non-traffic applications. Grate should be recessed 1/4" below finished grade in traffic applications. See page 71.					

Spee-D® Channel Accessories

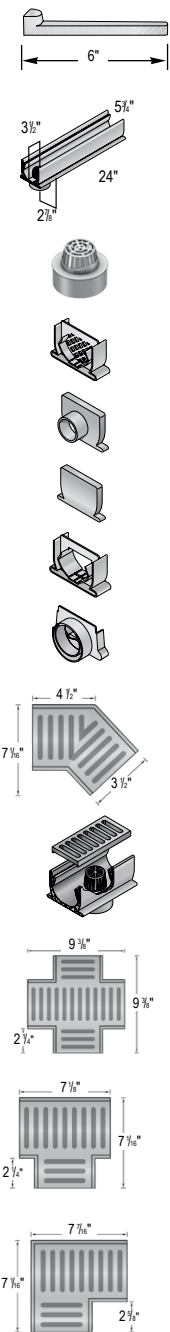

Part No.	Description	Color	Pkg. Qty.	Weight Ea. (lbs.)	Product Class
230	6" Channel Installation Stake	Gray	24	0.04	25PF
234	2' Spee-D Channel Drain with Atrium Strainer and Bottom Outlet to 3" and 4" Sewer and Drain Fittings	Gray	12	2.67	25PF
2350	Spee-D Channel Bottom Outlet insert to 3" and 4" Sewer and Drain Fittings	Gray	5	0.30	25PF
245	Spee-D Channel Strainer Coupling	Gray	20	0.35	25PF
246	Spee-D Channel End Outlet to 2" Sch. 40 Pipe Fittings	Gray	10	0.40	25PF
247	Spee-D Channel End Cap	Gray	10	0.40	25PF
248	Spee-D Channel Coupling	Gray	20	0.40	25PF
249	Spee-D Channel Offset End Outlet to 3" Sewer and Drain Pipe and 4" Sewer and Drain Fittings	Gray	10	0.50	25PF
2301	Fabricated 45° Elbow with Grate	Gray	1	2.00	25PF
2351	7" Fabricated Grate 4" Bottom Outlet with Grate	Gray	1	1.70	25PF
2361	Fabricated Cross and Grate	Gray	1	3.00	25PF
2371	Fabricated Tee with Grate	Gray	1	3.00	25PF
2381	Fabricated 90° Elbow with Grate	Gray	1	3.00	25PF

### 3" Pro Series Channel™ Drains

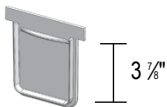
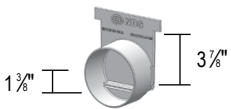
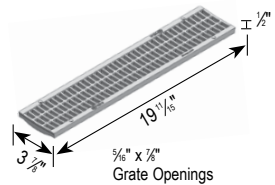
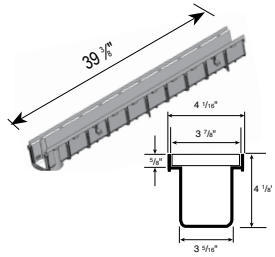
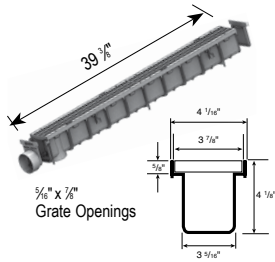





Part No.	Description	Color	Pkg. Qty.	Weight Ea. (lbs.)	Product Class	Specifications
764	3" x 1 Meter Light Traffic Channel Grate & Channel Drain Kit	Light Gray	10	3.50	25IN	3" wide Light Traffic Channel Grate and Channel Drain with mechanical interlocking joints and UV inhibitors. Open surface area 23.63 square inches per foot. 76.85 GPM per foot.
	Includes 1 end outlet (#713) and 1 end cap (#712). Bottom and end outlets fit 3" S&D fittings. Grate should be recessed 1/8" below finish grade in non-traffic applications. Grate should be recessed 1/4" in traffic applications. ADA Compliant, see page 71.					
710	3" x 1 Meter Channel Drain*	Light Gray	12	1.90	25IN	3" wide Light Traffic Channel with mechanical interlocking joints and UV inhibitors. Polypropylene.
	Bottom outlet fits 3" S&D fittings. Grate should be recessed 1/8" below finish grade in non-traffic applications. Grate should be recessed 1/4" in traffic applications. *Produced under license of First Plast S.R.L. - Italy. ADA Compliant, see page 71.					
714	3" x 20" Light Traffic Channel Grate*	Light Gray	24	0.70	25IN	3" wide Light Traffic Channel Grate. Open surface area 23.63 square inches per foot. 72.29 GPM per foot. Polypropylene.
	Requires #229 screws (quantity 4 per grate), see below. *Produced under license of First Plast S.R.L. - Italy. ADA Compliant, see page 71.					
713	3" End Cap/End Outlet	Light Gray	12	0.10	25IN	3" Channel End Cap/End Outlet. Polypropylene.
	Fits 3" Fittings.					
712	3" End Cap	Light Gray	20	0.05	25IN	3" Channel End Cap. Polypropylene.
229	Stainless Steel Screws FH H8 x 1"	Steel	48/Bag	0.06	25PF	

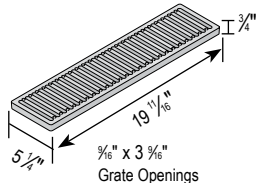
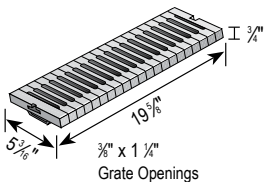
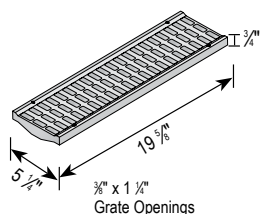
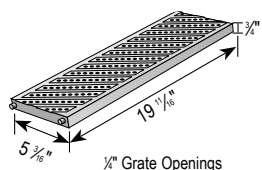
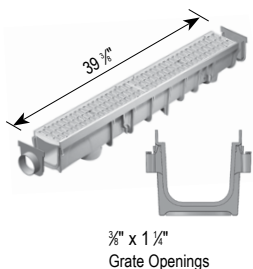

## 5" Pro Series Channel™ Drains



Part No.	Description	Color	Pkg. Qty.	Weight Ea. (lbs.)	Product Class	Specifications
864	5" x 1 Meter Light Traffic Channel Kit with Light Gray Plastic Grates. Includes 1 End Outlet & 1 Cap	Light Gray	9	5.67	25IN	5" wide Light Traffic Channel Drain Kits and Displays.
864DISPLAY	5" Pro Series Channel Kit with Plastic Grate Display (9 kits)	Light Gray	1 box = 9 kits	51.03	25IN	See related specifications for 800 Channel and 814 & 824 Grates. Includes channel, grates, screws, end cap and end cap/outlet.
864GMTL	5" x 1 Meter Light Traffic Channel Kit with Galvanized Steel Grates. Includes 1 End Outlet & 1 Cap	Galvanized Steel	9	6.15	25IN	DISP includes 9 kits either light gray plastic or galvanized steel grates
864GMTLDISP	5" Pro Series Channel Kit with Steel Grate Display (9 kits)	Galvanized Steel	1 box = 9 kits	55.35	25IN	
	Grate should be recessed 1/8" below finish grade in non-traffic applications. Grate should be recessed 1/4" below finish grade in traffic applications. ADA Compliant, see page 71.					
826	5" x 20" Pedestrian Traffic Channel Grate	Light Gray	10	1.00	25IN	5" wide UV-protected Structural Foam Polyolefin Pedestrian Traffic Channel Grate. Open surface area 4.86 square inches per foot. 24.26 GPM per foot.
	Requires #829 screws (quantity 4 per grate). ADA Compliant/Heelproof, see page 71.					
814	5" x 20" Light Traffic Channel Grate	Light Gray	10	1.16	25IN	5" wide Structural Foam Polyolefin Light Traffic Channel Grate with UV inhibitors. Open surface area 23.52 square inches per foot. 71.95 GPM per foot. 2 ft. Galvanized Steel Channel Grate. Open surface area 19.32 square inches per foot. 59.1 GPM per foot.
815	5" x 20" Light Traffic Channel Grate	Green	10	1.16	25IN	
816	5" x 20" Light Traffic Channel Grate	Black	10	1.16	25IN	
817	5" x 20" Light Traffic Channel Grate	Sand	10	1.16	25IN	
818	5" x 20" Light Traffic Channel Grate	Brick Red	10	1.16	25IN	
819	5" x 20" Light Traffic Channel Grate	White	10	1.16	25IN	
824	5" x 20" Galvanized Steel Light Traffic Channel Grate	Galvanized Steel	10	1.14	25IN	
	Requires #829 screws (quantity 4 per grate). ADA Compliant, see page 71.					
828	5" x 20" Load Star Heavy Traffic Channel Grate	Gray	10	2.35	25IN	5" wide UV-protected high-impact glass-reinforced nylon Heavy Traffic Channel Grate. Open surface area 15.92 square inches per foot. 48.70 GPM per foot.
	Requires #829 screws (quantity 4 per grate), see below. See page 71.					
823	5" x 20" Ductile Channel Grate	Black*	1	12.30	25IN	5" wide heavy-duty Ductile Heavy Traffic Channel Grate. Open surface area 22.90 square inches per foot. 70.05 GPM per foot.
	Requires #829 screws (quantity 4 per grate), see below. ADA Compliant, see page 71. *Painted for shipping & display only; grate will form iron-oxide patina					
829	Stainless Steel Screws FH #6 x 1 1/4"	Steel	40/Bag	0.15	25PF	

## 5" Pro Series Channel™ Drains

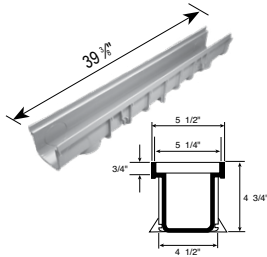

Part No.	Description	Color	Pkg. Qty.	Weight Ea. (lbs.)	Product Class	Specifications
800	5" x 1 Meter Deep Profile Channel Drain	Light Gray	10	4.00	25IN	5" wide Deep Profile Channel Drain with interlocking joints, side rebar clips, integrated side and bottom outlet Knockouts.
	New Integrated side outlet Knockouts fit 3" S&D pipe Integrated Knockout bottom outlet fits 3" and 4" S&D fittings. Grate should be recessed 1/8" below finish grade in non-traffic applications. Grate should be recessed 1/4" in traffic applications.					Polypropylene.

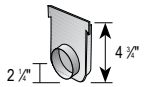

812	5" Deep Profile End Cap	Light Gray	10	0.13	25IN	5" wide Deep Profile End Cap. PVC.
-----	-------------------------	------------	----	------	------	------------------------------------

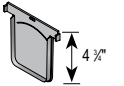

813	5" Deep Profile End Cap/3" S&D Hub & 4" S&D SPT Knockout End Outlet	Light Gray	10	0.40	25IN	5" wide Deep Profile End Cap/End Outlet. PVC.
-----	---	------------	----	------	------	---

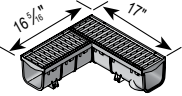

861	5" Deep Profile Grate & Channel Drain 90° Elbow	Light Gray	1	3.44	25IN	
-----	---	------------	---	------	------	--

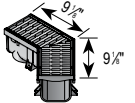

862	5" Deep Profile Grate & Channel Drain 45° Elbow	Light Gray	1	3.44	25IN	
-----	---	------------	---	------	------	--

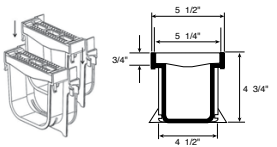

PSRC-864	Quik-Turn™ 5" Deep Radius Coupling Provides a 6 degree bend left or right	Light Gray	9	0.30	25IN	
----------	---	------------	---	------	------	--

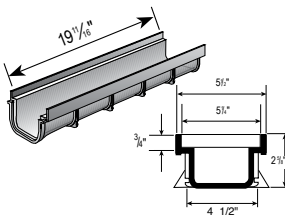

820	5" x 20" Shallow Profile Channel Drain*	Light Gray	10	1.35	25IN	5" wide Shallow Profile UV-protected high-impact PVC Channel Drain with mechanical interlocking joint.
	Grate should be recessed 1/8" below finish grade in non-traffic applications. Grate should be recessed 1/4" in traffic applications. *Produced under license of First Plast S.R.L.- Italy.					

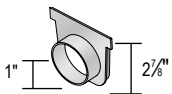



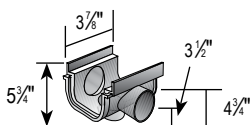

821	5" Shallow Profile End Cap/1-1/2" Sch. 40 SPT Knockout End Outlet*	Light Gray	10	0.15	25IN	5" wide Shallow Profile high-impact PVC End Cap/End Outlet.
	End Outlet fits 1-1/2" Schedule 40 fittings. *Produced under license of First Plast S.R.L.- Italy.					

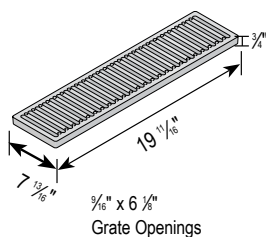
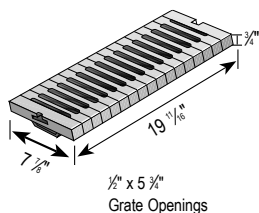
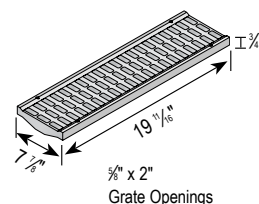
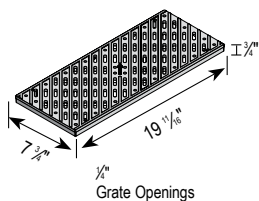

822	5" Shallow Profile 3" S&D SPT Bottom Outlet/1 1/2" Sch. 40 Hub Side Outlet	Light Gray	10	0.60	25IN	5" wide Shallow Profile high-impact PVC Bottom/Side Outlet.
	Side Outlets fit 1-1/2" Schedule 40 pipe Bottom Outlet fits 3" S&D fittings					

## 8" Pro Series Channel™ Drains



Part No.	Description	Color	Pkg. Qty.	Weight Ea. (lbs.)	Product Class	Specifications
836	8" x 20" Pedestrian Traffic Channel Grate	Light Gray	1	1.55	25IN	8" wide UV-protected Structural Foam Polyolefin Pedestrian Traffic Channel Grate. Open surface area 13.82 square inches per foot. 42.28 GPM per foot.
	Requires #829 screws (quantity 4 per grate). ADA Compliant/Heelproof, see page 71.					
837	8" x 20" Light Traffic Channel Grate	Light Gray	1	3.00	25IN	8" wide UV-protected Structural Foam Polyolefin Light Traffic Channel Grate. Open surface area 30.28 square inches per foot. 92.63 GPM per foot.
	Requires #829 screws (quantity 4 per grate), see below. See page 71.					
838	8" x 20" Load Star Heavy Traffic Channel Grate*	Gray	1	3.59	25IN	8" wide UV-protected high-impact glass-reinforced nylon Heavy Traffic Channel Grate. Open surface area 30.85 square inches per foot. 94.37 GPM per foot.
	Requires #829 screws (quantity 4 per grate). *Produced under license of First Plast S.R.L.- Italy. ADA Compliant, see page 71.					
888	8" x 20" Ductile Channel Grate	Black*	1	22.24	25IN	8" wide heavy-duty Ductile Heavy Traffic Channel Grate. Open surface area 23.80 square inches per foot. 71.28 GPM per foot.
	*Painted for shipping & display only; grate will form iron-oxide patina #829 screws may be used (quantity 4 per grate), see below.					
829	Stainless Steel Screws FH #6 x 1 1/4"	Steel	40/Bag	0.15	25PF	

## 8" Pro Series Channel™ Drains

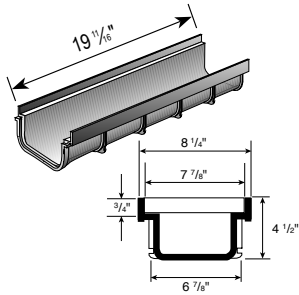

Part No.	Description	Color	Pkg. Qty.	Weight Ea. (lbs.)	Product Class	Specifications
830	8" x 20" Shallow Profile Channel Drain*	Light Gray	1	2.00	25IN	8" wide Shallow Profile high-impact PVC Channel Drain with mechanical interlocking joints and UV inhibitors.
Grate should be recessed 1/8" below finish grade in non-traffic applications. Grate should be recessed 1/4" in traffic applications. *Produced under license of First Plast S.R.L.- Italy.						

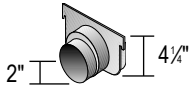

831	8" Shallow Profile End Cap/ 3" S&D SPT Knockout End Outlet*	Light Gray	1	0.49	25IN	8" wide Shallow Profile high-impact PVC End Cap/End Outlet.
End Outlet fits 3" Sewer and Drain fittings *Produced under license of First Plast S.R.L.- Italy.						

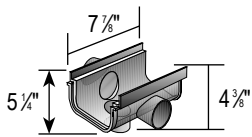

832	8" Shallow Profile 3" S&D SPT Side Outlet*	Light Gray	1	1.38	25IN	8" wide Shallow Profile high-impact PVC Bottom/ Side Outlets with bottom adapter.
Bottom outlet fits 4" S&D pipe, side outlets fit 3" Sewer and Drain fittings. *Produced under license of First Plast S.R.L.- Italy.						

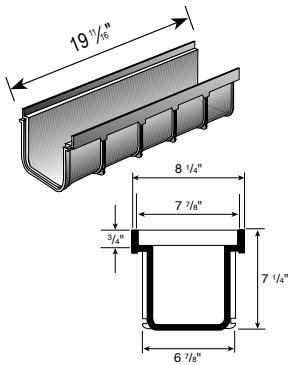

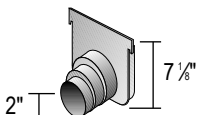

833	8" x 20" Deep Profile Channel Drain	Light Gray	1	2.80	25IN	8" wide Deep Profile high-impact PVC Channel Drain with mechanical interlocking joints and UV inhibitors.
Grate should be recessed 1/8" below finish grade in non-traffic applications. Grate should be recessed 1/4" in traffic applications.						

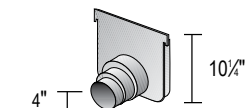
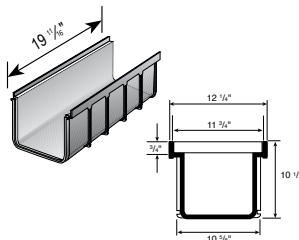
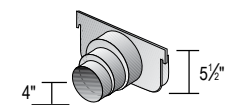
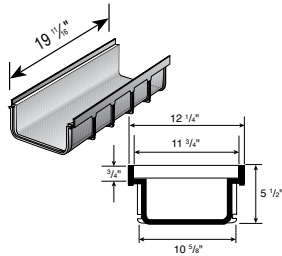
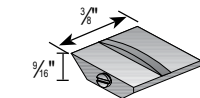
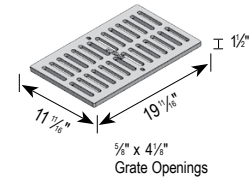
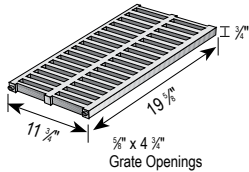

834	8" Deep Profile End Cap/3" & 4" S&D SPT Knockout End Outlet	Light Gray	10	0.51	25IN	8" wide Deep Profile high-impact PVC End Cap/End Outlet.
End Outlet fits 3" and 4" Sewer and Drain fittings *Produced under license of First Plast S.R.L.- Italy.						

## 12" Pro Series Channel™ Drains



Part No.	Description	Color	Pkg. Qty.	Weight Ea. (lbs.)	Product Class	Specifications
847	12" x 20" Light Traffic Channel Grate*	Gray	1	4.64	25IN	12" wide UV-protected high-impact PVC Light Traffic Channel Grate. Open surface area 48.77 square inches/foot. 149.19 GPM per foot.
	*Produced under license of First Plast S.R.L.- Italy. See page 71.					
885	12" x 20" Ductile Iron Heavy Traffic Channel Grate	Black*	1	29.30	25IN	12" Wide Cast Iron Heavy Traffic Channel Grate. Open surface area 46.70 square inches per foot. 142.86 GPM per foot.
	*Painted for shipping & display only; grate will form iron-oxide patina See page 71.					
849	Grate Security Clip*	Gray	10	0.40	25IN	
	For use with 847 and 885 grates and 840 or 843 channels only (2 per grate). Mounts inside channel drain and secures grate. Screw and nut included. *Produced under license of First Plast S.R.L.- Italy.					
840	12" x 20" Shallow Profile Channel Drain	Light Gray	1	4.00	25IN	12" wide Shallow Profile UV-protected high-impact PVC Channel Drain with mechanical interlocking joints.
	Grate should be recessed 1/8" below finish grade in non-traffic applications. Grate should be recessed 1/4" in traffic applications.					
841	12" Shallow Profile End Cap/End Outlet Knockout with 4" S&D Hub*	Light Gray	1	1.00	25IN	12" wide Shallow Profile high-impact PVC End Cap/Outlet with adapter.
	*Produced under license of First Plast S.R.L.- Italy.					
843	12" x 20" Deep Profile Channel Drain*	Light Gray	1	6.00	25IN	12" wide Deep Profile UV-protected high-impact PVC Channel Drain with mechanical interlocking joints.
	Grate should be recessed 1/8" below finish grade in non-traffic applications. Grate should be recessed 1/4" in traffic applications. *Produced under license of First Plast S.R.L.- Italy.					
844	12" Deep Profile End Cap/End Outlet Knockout with 4" S&D Hub*	Light Gray	1	1.60	25IN	12" wide Deep Profile high-impact PVC End Cap/Outlet with adapter.
	*Produced under license of First Plast S.R.L.- Italy.					

## Channel Drains

### Dura Slope® Channel Drain Sections

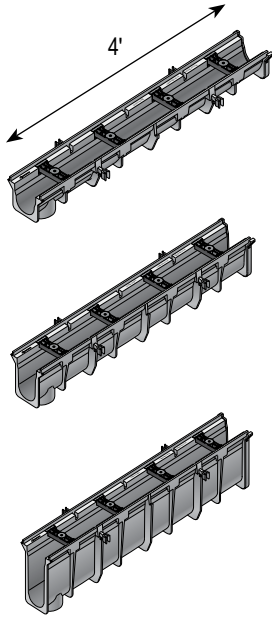

Part No.	Description	Slope	Invert		Material	Weight Ea. (lbs.)	Unit	Product Class
			In	Out				
DS-091	6 in. W x 4 ft. L	0.7% SLOPED	4.75	5.08	HDPE	7.5	1	25DS
DS-091N	6 in. W x 4 ft. L	0.0% NEUTRAL	5.08	5.08	HDPE	7.8	1	25DS
DS-092	6 in. W x 4 ft. L	0.7% SLOPED	5.08	5.42	HDPE	7.9	1	25DS
DS-093	6 in. W x 4 ft. L	0.7% SLOPED	5.42	5.76	HDPE	8.3	1	25DS
DS-094	6 in. W x 4 ft. L	0.7% SLOPED	5.76	6.09	HDPE	8.6	1	25DS
DS-094N	6 in. W x 4 ft. L	0.0% NEUTRAL	6.09	6.09	HDPE	8.9	1	25DS
DS-095	6 in. W x 4 ft. L	0.7% SLOPED	6.09	6.43	HDPE	9	1	25DS
DS-096	6 in. W x 4 ft. L	0.7% SLOPED	6.43	6.76	HDPE	9.4	1	25DS
DS-097	6 in. W x 4 ft. L	0.7% SLOPED	6.76	7.1	HDPE	9.7	1	25DS
DS-097N	6 in. W x 4 ft. L	0.0% NEUTRAL	7.1	7.1	HDPE	10	1	25DS
DS-098	6 in. W x 4 ft. L	0.7% SLOPED	7.1	7.44	HDPE	10.1	1	25DS
DS-099	6 in. W x 4 ft. L	0.7% SLOPED	7.44	7.77	HDPE	10.5	1	25DS
DS-100	6 in. W x 4 ft. L	0.7% SLOPED	7.77	8.11	HDPE	10.9	1	25DS
DS-100N	6 in. W x 4 ft. L	0.0% NEUTRAL	8.11	8.11	HDPE	11.2	1	25DS
DS-101	6 in. W x 4 ft. L	0.7% SLOPED	8.11	8.44	HDPE	11.2	1	25DS
DS-102	6 in. W x 4 ft. L	0.7% SLOPED	8.44	8.78	HDPE	11.6	1	25DS
DS-103	6 in. W x 4 ft. L	0.7% SLOPED	8.78	9.12	HDPE	12	1	25DS
DS-103N	6 in. W x 4 ft. L	0.0% NEUTRAL	9.12	9.12	HDPE	12.3	1	25DS
DS-104	6 in. W x 4 ft. L	0.7% SLOPED	9.12	9.45	HDPE	12.3	1	25DS
DS-105	6 in. W x 4 ft. L	0.7% SLOPED	9.45	9.79	HDPE	12.7	1	25DS
DS-106	6 in. W x 4 ft. L	0.7% SLOPED	9.79	10.12	HDPE	13.1	1	25DS
DS-106N	6 in. W x 4 ft. L	0.0% NEUTRAL	10.12	10.12	HDPE	13.4	1	25DS
DS-107	6 in. W x 4 ft. L	0.7% SLOPED	10.12	10.46	HDPE	13.4	1	25DS
DS-108	6 in. W x 4 ft. L	0.7% SLOPED	10.46	10.8	HDPE	13.8	1	25DS
DS-109	6 in. W x 4 ft. L	0.7% SLOPED	10.8	11.13	HDPE	14.2	1	25DS
DS-109N	6 in. W x 4 ft. L	0.0% NEUTRAL	11.13	11.13	HDPE	14.5	1	25DS
DS-110	6 in. W x 4 ft. L	0.7% SLOPED	11.13	11.47	HDPE	14.6	1	25DS
DS-111	6 in. W x 4 ft. L	0.7% SLOPED	11.47	11.8	HDPE	15	1	25DS
DS-112	6 in. W x 4 ft. L	0.7% SLOPED	11.8	12.14	HDPE	15.3	1	25DS
DS-112N	6 in. W x 4 ft. L	0.0% NEUTRAL	12.14	12.14	HDPE	15.6	1	25DS
DS-113	6 in. W x 4 ft. L	0.7% SLOPED	12.14	12.48	HDPE	15.7	1	25DS
DS-114	6 in. W x 4 ft. L	0.7% SLOPED	12.48	12.81	HDPE	16.1	1	25DS

### Dura Slope® In-Line Catch Basin

The NDS Dura Slope® in-line catch basin is designed to fit all depth ranges of the Dura Slope® trench drain sections. Catch basin inlets are designed to be sized as required to accept the Dura Slope® trench drain section. The Dura Slope® catch basin is 2 feet long and 2 feet deep with an outlet on both sides of the basin. One Universal Adapter Plug, one blank grate insert and two grate screws are included with each Dura Slope® in-line catch basin. The NDS universal basin outlets are used to adapt the catch basin to 3", 4", 6" and 8" pipe.

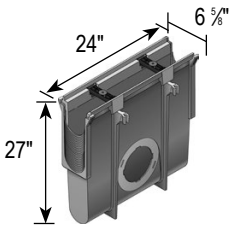

Part No.	Description	Color	Pkg. Qty.	Wt. Ea. (lbs.)	Product Class
DS-340	Dura Slope® In-Line Catch Basins	Light Gray	1	16.00	25DS
Available for use of one or two outlets. Use #1243, #1245, #1266, #1206 or #1888 Universal Outlets, see page 18.					

### Dura Slope® Trash Bucket

Dura Slope® Trash Bucket is made to fit inside the Dura Slope® Catch Basin (part number DS-340). It has a handle for easy removal to clean leaves and debris; it requires removal of the grate. Made of zinc plated steel, it is durable to climatic conditions. The Trash Bucket is not intended for use with any of the Dura Slope® Channels.  
**Note:** DS-240 Trash Bucket is not for use with the DS-200H Ductile Iron Frame.

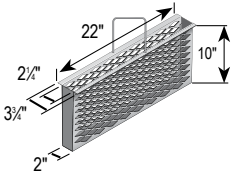

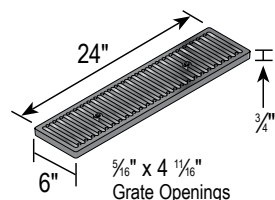
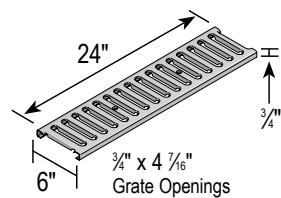
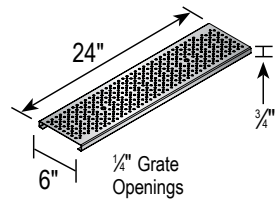
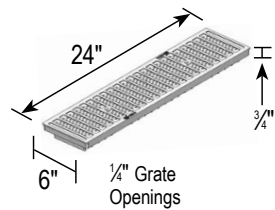
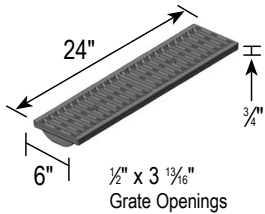

Part No.	Description	Color	Pkg. Qty.	Wt. Ea. (lbs.)	Product Class
DS-240	Dura Slope® Trash Bucket	Steel Zinc-Plated Steel	1	5.00	25DS

## Dura Slope® Standard Grates



Part No.	Description	Color	Pkg. Qty.	Weight Ea. (lbs.)	Product Class	Specifications
660	2 ft. Channel Grate	White	1	2.82	25DS	2 ft. Structural Foam Polyolefin, secured Channel Grate with UV inhibitor. Open surface area 25.40 square inches per foot. 77.70 GPM per foot.
661	2 ft. Channel Grate	Dark Gray	1	2.82	25DS	
661LG	2 ft. Channel Grate	Light Gray	1	2.82	25DS	
662	2 ft. Channel Grate	Green	1	2.82	25DS	
663	2 ft. Channel Grate	Black	1	2.82	25DS	
664	2 ft. Channel Grate	Sand	1	2.82	25DS	
665	2 ft. Channel Grate	Brick Red	1	2.82	25DS	
 Use with Dura Slope Drains (page 54), Dura Slope Catch Basins (page 55). ADA Compliant, see page 71.						

DS-670	2 ft. Plastic Perforated Channel Grate	Light Gray	1	2.81	25DS	2 ft. Structural Foam Polyolefin, secured Channel Grate with UV inhibitor, light traffic rated, heelproof, ADA compliant. Open surface area 8.75 square inches per foot. 26.77 GPM per foot.
DS-671	2 ft. Plastic Perforated Channel Grate	White	1	2.81	25DS	
 Use with Dura Slope Drains (page 54), Dura Slope Catch Basins (page 55). ADA Compliant, see page 71.						

DS-226	2 ft. Stainless Steel Perforated Channel Grate	Steel	1	3.16	25DS	Perforated Metal Grate, pedestrian traffic rated, heelproof, ADA compliant. Open surface area 7.63 square inches per foot. 23.34 GPM per foot.
DS-228	2 ft. Galvanized Steel Perforated Channel Grate	Steel	1	3.83	25DS	
 Use with Dura Slope Drains (page 54), Dura Slope Catch Basins (page 55). ADA Compliant/Heelproof, see page 71. SS 304 (grade of material).						

DS-221	2 ft. Galvanized Steel Channel Grate	Steel	1	6.64	25DS	Open surface area 23.09 square inches per foot; 70.64 GPM
DS-231	2 ft. Cast Iron Channel Grate*	Black	1	18.90	25DS	2 ft. heavy-duty Iron Channel Grate. Open surface area 20.85 square inches per foot. 63.78 GPM per foot. H-20 load rating.
DS-232	2 ft. Ductile Iron	Black	1	15.20	25DS	
 Use with Dura Slope Drains (page 54), Dura Slope Catch Basins (page 55). ADA Compliant, see page 71. Must be used with DS-200H to achieve Class D Load Rating. *coated black for shipping						



Dura Slope® Decorative Grates

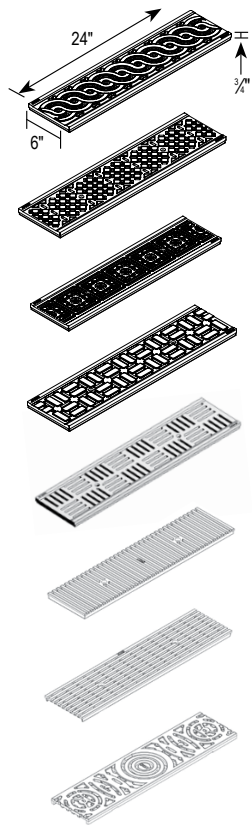

Part No.	Description	Color	Pkg. Qty.	Wt. Ea. (lbs.)	Product Class	Specifications
DS-601	Weave Pattern	Cast Iron	1	11.70	25DS	Weave: open area 7.92 square inches per foot; 24.3 GPM.
DS-602	Diamond Pattern	Cast Iron	1	14.30	25DS	Diamond: open area 9.25 square inches per foot; 28.3 GPM.
DS-603	Tile Pattern	Cast Iron	1	14.70	25DS	Tile: open area 11.93 square inches per foot; 33.6 GPM.
DS-604	Brick Pattern	Cast Iron	1	14.30	25DS	Brick: open area 9.72 square inches per foot; 29.8 GPM.
DS-609	Deco Slot	Cast Iron	1	11.70	25DS	Deco Slot: open area 17.46 square inches per foot; 53.5 GPM
DS-610-KIARO	Kiaro Slot	Ductile Iron*	1	14.99	25DS	Kiaro Slot: open area 24.57 square inches per foot; 75.8 GPM
DS-611-VIA	Via Slot	Ductile Iron*	1	10.36	25DS	Via Slot: open area 22.9 square inches per foot; 70.1 GPM
DS-612-VILLE	Ville Pattern	Ductile Iron*	1	11.68	25DS	Ville: open area 10.07 square inches per foot; 30.9 GPM
 Use with Dura Slope Drains (page 54). Decorative grates are made of ductile iron. Uncoated raw iron will develop a rust patina over time. ADA Compliant/ Heel-proof. Must be used with DS-200H frame to achieve Class D Load Rating, see page 71. *Coated black for shipping						

Dura Slope® Slot Top



Part No.	Description	Color	Pkg. Qty.	Weight Ea. (lbs.)	Product Class	Specifications
DS-ST4	4 ft. Slot Top, Galvanized Steel Grate	Galvanized Steel	1	17.53	25DS	Open area 5.76 square inches per linear foot; 17.65 GPM
DS-ST2	2 ft. Slot Top, Galvanized Steel Grate	Galvanized Steel	1	8.86	25DS	
DS-STMAINT	2 ft. Slot Top Maintenance Unit	Galvanized Steel	1	14.86	25DS	
DS-SS-ST1000	48 in. Slot Top, Asymmetric, Stainless Steel	Stainless Steel	1	17.13	25DS	
DS-SS-ST500	24 in. Slot Top, Asymmetric, Stainless Steel	Stainless Steel	1	8.86	25DS	
DS-SS-STMAINT	24 in. Maintenance Unit Stainless Steel	Stainless Steel	1	14.86	25DS	
13399	Opening Tool for Maintenance Unit (order 2)	N/A	1	0.02	25FC	

SS 304 (grade of material)

## Ductile Iron Frame

Dura Slope® Ductile Iron Frame provides a Class D load rating of 326-575 psi and is suitable for heavy-duty hard tire equipment at speeds less than 20 mph. The DS-200H Ductile Iron Frame is recommended for use with pneumatic tire traffic such as fork lifts. The ductile iron frame can be used with the cast and ductile iron grates. **Note:** DS-123 screws must be ordered to secure frame to the channel.

Part No.	Description	Color	Pkg. Qty.	Weight Ea. (lbs.)	Product Class
DS-200H	Dura Slope® Ductile Iron Frame	Black*	2 ft.	7.50	25DS
	Use with Dura Slope Drains (page 54), Dura Slope Catch Basins (page 55). To be used with DS-231 or DS-232 grates (see page 560. New Feature: 1/4" Brass Nuts to secure channel inserted. ADA Compliant/Heel-proof (see page 71) when used with DS-231 or DS-232 grates. *Coated black for shipping				

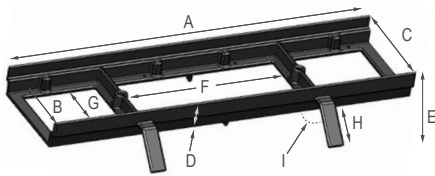

Iron Frame Dimension Key					
A	Length	24"	F	Opening Length	10-3/4"
B	Inner Width	6"	G	Opening Width	4-1/2"
C	Outer Width	6-3/8"	H	Length of Anchor	2-5/8"
D	Added Profile	1" Height	I	Angle of Anchor	30°
E	Total Height	2-3/4"			

## Dura Slope® Accessories

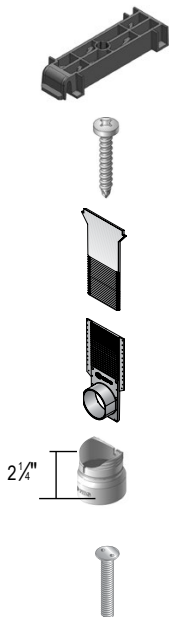

Part No.	Description	Color	Pkg. Qty.	Weight Ea. (lbs.)	Product Class
DS-122	ProFit™ Grate Lock	Black	8	0.17	25DS
DS-123	Dura Slope Frame & End Cap Screws PH. #6	Stainless Steel	12		25DS
	REPLACEMENT- included with channels and basin. Use on DS-229 Universal End Cap & DS-227 x 3/4". Universal End Outlet downstream for (male) end. Use to attach DS-200 DI Frame to Channel.				
DS-224	Universal End Cap	Gray	8	0.63	25DS
	Replaces DS-124, which will not work with DS-113 or deeper channels. Slides into upstream (female) end. Requires DS-123 screws on downstream (male) end.				
DS-227	Universal End Outlet	Gray	6	0.75	25DS
	Replaces DS-127, which will not work with DS-113 or deeper channels. Requires DS-123 screws for use on downstream (male) end. Fits to 4" S&D Pipe.				
DS-126	Bottom Outlet Adapter	Gray	6	0.53	25DS
	Fits to 4" S&D Pipe. DS-126 not required for Sch. 40 connection. DS-126 not required for Sch. 4 in. 40 connection.				
629	Grate Screws FH # 1/4 – 20 x 1-1/2"	Stainless Steel	40	2.8 (pk. of 20)	25PF
	2 Needed per Grate. Use with Grate # DS-231, DS-232, DS-670, DS-226 and 660-665.				
DS-650	Flat Drilled Spanner End Cap Screws #6, 3/4"	Stainless Steel	12	.60 (pk. 60)	25DS
	Drill bit included with each package.				

We put water in its place™

Dura Slope® EZ-Track™ Radius Coupling & Grates



Part No.	Description	Color	Pkg. Qty.	Weight Ea. (lbs.)	Product Class	Specificationa
DSRC-097	6.35" Deep Neutral Dura Slope® Radius Coupling	Light Gray	6	0.81	25DS	3 degree max. deflection per coupling. Minimum inside radius of 26".
DSRC-100	7.36" Deep Neutral Dura Slope® Radius Coupling	Light Gray	6	0.82	25DS	
DSRC-103	8.37" Deep Neutral Dura Slope® Radius Coupling	Light Gray	6	0.83	25DS	
DSRC-106	9.37" Deep Neutral Dura Slope® Radius Coupling	Light Gray	6	0.84	25DS	
DSRC	Dura Slope® Radius Coupling	Light Gray	6	1.13	25DS	
DSRC can be trimmed to fit any depth channel and is compatible with sloped channels						



DS-660MG	1.25" Plastic Slotted Radius Coupling Grate	White	6	0.15	25DS	Structural Foam Polyolefin Radius Coupling Channel Grate with UV inhibitor. Open surface area 1.88 square inches per grate. 5.75 GPM per grate.
DS-661MG	1.25" Plastic Slotted Radius Coupling Grate	Dark Gray	6	0.15	25DS	
DS-661LGMG	1.25" Plastic Slotted Radius Coupling Grate	Light Gray	6	0.15	25DS	
DS-662MG	1.25" Plastic Slotted Radius Coupling Grate	Green	6	0.15	25DS	
DS-663MG	1.25" Plastic Slotted Radius Coupling Grate	Black	6	0.15	25DS	
DS-664MG	1.25" Plastic Slotted Radius Coupling Grate	Sand	6	0.15	25DS	



DS-681LGMG	1.25" Plastic Standard Radius Coupling Grate (no slot) (included with DSRC Coupling)	Light Gray	6	0.16	25DS	Solid Structural Foam Polyolefin Radius Coupling Channel Grate with UV inhibitor.
------------	--	------------	---	------	------	---

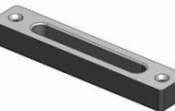

DS-232MG	1.25" Ductile Iron Radius Coupling Grate	Black	6	0.93	25DS	Ductile Iron Radius Coupling Channel Grate. Open surface area 1.88 square inches per grate. 5.75 GPM per grate.
----------	--	-------	---	------	------	---



DS-226MG	1.25" Perforated Stainless Steel Radius Coupling Grate	Steel	6	0.25	25DS	Stainless Steel Radius Coupling Channel Grate. Open surface area 0.86 square inches per grate. 2.63 GPM per grate.
----------	--	-------	---	------	------	--

## Trench Drains

### 4" BG-FILCOTEN® tec V 100 Trench Drains, galvanized rails

BG-FILCOTEN tec v 100 trench drain system is available with galvanized rails in pre-slope and neutral sections with load ratings from Class A to E 600 (in accordance to DIN 19580). Stainless steel rails and grates are also available.

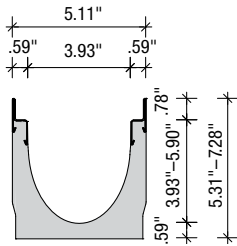
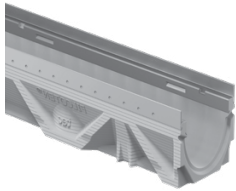

Part No.	Description	Slope	Depth	Invert		Rail	Weight (Less Grate)		Unit	Class
				In	Out		Lbs.	Kg.		
10410200	tec V 100 (1 Meter) 4" W x 39.4" L	0.0% NEUTRAL	0-0	4.72	4.72	Galv.	28.7	13	1	25FC
10410201	tec V 100 (1 Meter) 4" W x 39.4" L	0.5% SLOPED	1	4.72	4.92	Galv.	29.5	13.4	1	25FC
10410202	tec V 100 (1 Meter) 4" W x 39.4" L	0.5% SLOPED	2	4.92	5.12	Galv.	31.1	14.1	1	25FC
10410203	tec V 100 (1 Meter) 4" W x 39.4" L	0.5% SLOPED	3	5.12	5.31	Galv.	32.6	14.8	1	25FC
10410204	tec V 100 (1 Meter) 4" W x 39.4" L	0.5% SLOPED	4	5.31	5.51	Galv.	34	15.4	1	25FC
10410205	tec V 100 (1 Meter) 4" W x 39.4" L	0.5% SLOPED	5	5.51	5.71	Galv.	35.1	15.9	1	25FC
10410261	tec V 100 (1 Meter) 4" W x 39.4" L	0.0% NEUTRAL	5-0	5.71	5.71	Galv.	35.5	16.1	1	25FC
10410206	tec V 100 (1 Meter) 4" W x 39.4" L	0.5% SLOPED	6	5.71	5.91	Galv.	36.2	16.4	1	25FC
10410207	tec V 100 (1 Meter) 4" W x 39.4" L	0.5% SLOPED	7	5.91	6.1	Galv.	37	16.8	1	25FC
10410208	tec V 100 (1 Meter) 4" W x 39.4" L	0.5% SLOPED	8	6.1	6.3	Galv.	38.4	17.4	1	25FC
10410209	tec V 100 (1 Meter) 4" W x 39.4" L	0.5% SLOPED	9	6.3	6.5	Galv.	39.7	18	1	25FC
10410210	tec V 100 (1 Meter) 4" W x 39.4" L	0.5% SLOPED	10	6.5	6.69	Galv.	40.8	18.5	1	25FC
10410262	tec V 100 (1 Meter) 4" W x 39.4" L	0.0% NEUTRAL	10-0	6.69	6.69	Galv.	41.2	18.7	1	25FC
10410211	tec V 100 (1 Meter) 4" W x 39.4" L	0.5% SLOPED	11	6.69	6.89	Galv.	41.9	19	1	25FC
10410212	tec V 100 (1 Meter) 4" W x 39.4" L	0.5% SLOPED	12	6.89	7.09	Galv.	44.8	20.3	1	25FC
10410213	tec V 100 (1 Meter) 4" W x 39.4" L	0.5% SLOPED	13	7.09	7.28	Galv.	47.6	21.6	1	25FC
10410214	tec V 100 (1 Meter) 4" W x 39.4" L	0.5% SLOPED	14	7.28	7.48	Galv.	50.5	22.9	1	25FC
10410215	tec V 100 (1 Meter) 4" W x 39.4" L	0.5% SLOPED	15	7.48	7.68	Galv.	53.4	24.2	1	25FC
10410216	tec V 100 (1 Meter) 4" W x 39.4" L	0.5% SLOPED	16	7.68	7.87	Galv.	55.6	25.5	1	25FC
10410217	tec V 100 (1 Meter) 4" W x 39.4" L	0.5% SLOPED	17	7.87	8.07	Galv.	59.1	26.8	1	25FC
10410218	tec V 100 (1 Meter) 4" W x 39.4" L	0.5% SLOPED	18	8.07	8.27	Galv.	62	28.1	1	25FC
10410219	tec V 100 (1 Meter) 4" W x 39.4" L	0.5% SLOPED	19	8.27	8.46	Galv.	64.8	29.4	1	25FC
10410220	tec V 100 (1 Meter) 4" W x 39.4" L	0.5% SLOPED	20	8.46	8.66	Galv.	67.7	30.7	1	25FC
10410264	tec V 100 (1 Meter) 4" W x 39.4" L	0.0% NEUTRAL	20-0	8.66	8.66	Galv.	69.9	31.7	1	25FC

#### Filcoten Channel Mini

10510200	Mini (1 Meter) 4" W x 39.4" L	0.0% NEUTRAL	60 mm	1.37	1.37	Galv.	20.06	9.1	1	25FC
10510201	Mini (1 Meter) 4" W x 39.4" L	0.0% NEUTRAL	80 mm	2.16	2.16	Galv.	23.59	10.7	1	25FC

We put water in its place™

4" BG-FILCOTEN® tec V 100 Trench Drains, stainless steel rails



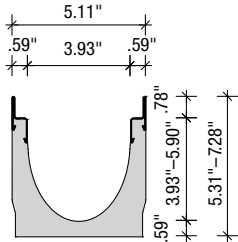
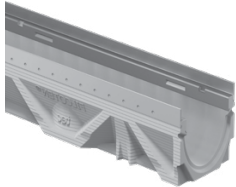





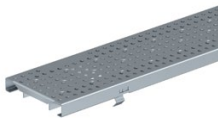



Channel Drains



Part No.	Description	Slope	Depth	Invert		Rail	Weight (Less Grate)		Unit	Class
				In	Out		Lbs.	Kg.		
10410300	tec V 100 (1 Meter) 4" W x 39.4" L	0.0% NEUTRAL	0-0	4.72	4.72	St. Steel	28.7	13	1	25FC
10410301	tec V 100 (1 Meter) 4" W x 39.4" L	0.5% SLOPED	1	4.72	4.92	St. Steel	29.5	13.4	1	25FC
10410302	tec V 100 (1 Meter) 4" W x 39.4" L	0.5% SLOPED	2	4.92	5.12	St. Steel	31.1	14.1	1	25FC
10410303	tec V 100 (1 Meter) 4" W x 39.4" L	0.5% SLOPED	3	5.12	5.31	St. Steel	32.6	14.8	1	25FC
10410304	tec V 100 (1 Meter) 4" W x 39.4" L	0.5% SLOPED	4	5.31	5.51	St. Steel	34	15.4	1	25FC
10410305	tec V 100 (1 Meter) 4" W x 39.4" L	0.5% SLOPED	5	5.51	5.71	St. Steel	35.1	15.9	1	25FC
10410361	tec V 100 (1 Meter) 4" W x 39.4" L	0.0% NEUTRAL	5-0	5.71	5.71	St. Steel	35.5	16.1	1	25FC
10410306	tec V 100 (1 Meter) 4" W x 39.4" L	0.5% SLOPED	6	5.71	5.91	St. Steel	36.2	16.4	1	25FC
10410307	tec V 100 (1 Meter) 4" W x 39.4" L	0.5% SLOPED	7	5.91	6.1	St. Steel	37	16.8	1	25FC
10410308	tec V 100 (1 Meter) 4" W x 39.4" L	0.5% SLOPED	8	6.1	6.3	St. Steel	38.4	17.4	1	25FC
10410309	tec V 100 (1 Meter) 4" W x 39.4" L	0.5% SLOPED	9	6.3	6.5	St. Steel	39.7	18	1	25FC
10410310	tec V 100 (1 Meter) 4" W x 39.4" L	0.5% SLOPED	10	6.5	6.69	St. Steel	40.8	18.5	1	25FC
10410362	tec V 100 (1 Meter) 4" W x 39.4" L	0.0% NEUTRAL	10-0	6.69	6.69	St. Steel	41.2	18.7	1	25FC
10410311	tec V 100 (1 Meter) 4" W x 39.4" L	0.5% SLOPED	11	6.69	6.89	St. Steel	41.9	19	1	25FC
10410312	tec V 100 (1 Meter) 4" W x 39.4" L	0.5% SLOPED	12	6.89	7.09	St. Steel	44.8	20.3	1	25FC
10410313	tec V 100 (1 Meter) 4" W x 39.4" L	0.5% SLOPED	13	7.09	7.28	St. Steel	47.6	21.6	1	25FC
10410314	tec V 100 (1 Meter) 4" W x 39.4" L	0.5% SLOPED	14	7.28	7.48	St. Steel	50.5	22.9	1	25FC
10410315	tec V 100 (1 Meter) 4" W x 39.4" L	0.5% SLOPED	15	7.48	7.68	St. Steel	53.4	24.2	1	25FC
10410316	tec V 100 (1 Meter) 4" W x 39.4" L	0.5% SLOPED	16	7.68	7.87	St. Steel	55.6	25.5	1	25FC
10410317	tec V 100 (1 Meter) 4" W x 39.4" L	0.5% SLOPED	17	7.87	8.07	St. Steel	59.1	26.8	1	25FC
10410318	tec V 100 (1 Meter) 4" W x 39.4" L	0.5% SLOPED	18	8.07	8.27	St. Steel	62	28.1	1	25FC
10410319	tec V 100 (1 Meter) 4" W x 39.4" L	0.5% SLOPED	19	8.27	8.46	St. Steel	64.8	29.4	1	25FC
10410320	tec V 100 (1 Meter) 4" W x 39.4" L	0.5% SLOPED	20	8.46	8.66	St. Steel	67.7	30.7	1	25FC
10410364	tec V 100 (1 Meter) 4" W x 39.4" L	0.0% NEUTRAL	20-0	8.66	8.66	St. Steel	69.9	31.7	1	25FC

## 4" BG-FILCOTEN® tec V 100 Grates



Part No.	Description	Grate Type	Length	Heel Proof	ADA	Load Class
17010204	NW100 4" Grate	Galv. Perf.	1 Meter			A
17010205	NW100 4" Grate	Galv. Perf.	0.5 Meter			A
17010202	NW100 4" Grate	Galv. Slotted	1 Meter			A
17010203	NW100 4" Grate	Galv. Slotted	0.5 Meter			A
17010220	NW100 4" Grate	Galv. Mesh	1 Meter			B
17010221	NW100 4" Grate	Galv. Mesh	0.5 Meter			B
17010330	NW100 4" Grate	Stainless Long Bar	1 Meter			B
17010401	NW100 4" Grate	Combee Plastic	0.5 Meter			B
17010402	NW100 4" Grate	Combee Plastic	0.5 Meter			C
17010228	NW100 4" Grate	Galv. Perf.	1 Meter			C
17010229	NW100 4" Grate	Galv. Perf.	0.5 Meter			C
17010328	NW100 4" Grate	Stainless Perf	1 Meter			C
17010329	NW100 4" Grate	Stainless Perf	0.5 Meter			C
17010206	NW100 4" Grate	Galv. Slotted	1 Meter			C
17010207	NW100 4" Grate	Galv. Slotted	0.5 Meter			C

We put water in its place™

4" BG-FILCOTEN® tec V 100 Grates



Part No.	Description	Grate Type	Length	Heel Proof	ADA	Load Class
17111204	NW100 4" Grate	Galv. Slot Top	1 Meter			C
17111205	NW100 4" Grate	Galv. Slot Top	0.5 Meter			C
17111206	NW100 4" Grate	Galv. Slot Maint	0.5 Meter			C
17111304	NW100 4" Grate	Stainless Slot Top	1 Meter			C
17111305	NW100 4" Grate	Stainless Slot Top	0.5 Meter			C
17111306	NW100 4" Grate	Stainless Slot Maint	0.5 Meter			C



17010106	NW100 4" Grate	Ductile Bar	0.5 Meter			C
----------	----------------	-------------	-----------	--	--	---



17010110	NW100 4" Grate	Ductile Bar	0.5 Meter			D
----------	----------------	-------------	-----------	--	--	---



17010187	NW100 4" Grate	Ductile Torrent	.5 Meter			D
----------	----------------	-----------------	----------	--	--	---



17010183	NW100 4" Grate	Ductile Kiaro Bar	0.5 Meter			D
----------	----------------	-------------------	-----------	--	--	---



17010184	NW100 4" Grate	Ductile Via Long	0.5 Meter			D
----------	----------------	------------------	-----------	--	--	---



17010105	NW100 4" Grate	Ductile Bar	0.5 Meter			E
----------	----------------	-------------	-----------	--	--	---

17010106	NW100 4" Grate	Ductile Bar	0.5 Meter			E
----------	----------------	-------------	-----------	--	--	---



17010180	NW100 4" Grate	Ductile Ville	0.5 Meter			E
----------	----------------	---------------	-----------	--	--	---

## 4" BG-FILCOTEN® tec V 100 Accessories

BG-FILCOTEN tec V 100 Sump Unit

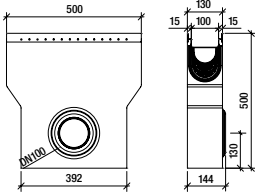
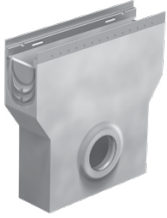

Part No.	Description	Material	Weight Ea. (lbs.)	Product Class
19011204	tec V 100 No Hub Bottom Outlet	Galvanized Steel	0.66	25FC
22515	tec V 100 Silt Bucket for Sump	Plastic	0.44	25FC
32087	tec V 100 Anti-Vandalism Locking Device	Stainless Steel	0.22	25FC
19011204	tec V 100 Bottom Outlet	Galvanized Steel	0.66	25FC
19010400	tec V 100 End Cap Blank w/Knockout Outlet	Plastic		25FC
19010902	tec V 100 Rebar Support	Galvanized Steel	2.7	25FC
13399	Maintenance Box Opening Tool	N/A	0.22	25FC
10410294	tec V 100 Sump Kit	N/A	26.55	25FC



## 8" BG-FILCOTEN® pro V 200 Trench Drains

BG-FILCOTEN pro V 200 is stable, yet lightweight, so you don't have to compromise on quality or durability. It is available with galvanized rails in neutral and sloped sections and up to load class E 600 (according to EN1433). Stainless steel rails and grates are also available.

BG-FILCOTEN pro V 200  
Galvanized Steel Trench Drain

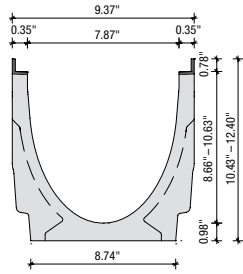
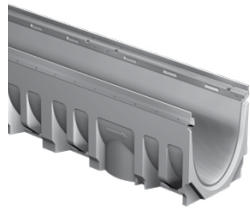





Part No.	Description	Slope	Depth	Invert		Rail	Weight (Less Grate)		Unit	Class
				In	Out		Lbs.	Kg.		
10620200	pro V 200 (1 Meter) 8" W x 39.4" L	0.0% NEUTRAL	0-0	9.45	9.45	Galv.	97	44	1	25FC
10620201	pro V 200 (1 Meter) 8" W x 39.4" L	0.5% SLOPED	1	9.45	9.65	Galv.	98.1	44.5	1	25FC
10620202	pro V 200 (1 Meter) 8" W x 39.4" L	0.5% SLOPED	2	9.65	9.84	Galv.	100.3	45.5	1	25FC
10620203	pro V 200 (1 Meter) 8" W x 39.4" L	0.5% SLOPED	3	9.84	10.04	Galv.	102.5	46.5	1	25FC
10620204	pro V 200 (1 Meter) 8" W x 39.4" L	0.5% SLOPED	4	10.04	10.24	Galv.	104.9	45.6	1	25FC
10620205	pro V 200 (1 Meter) 8" W x 39.4" L	0.5% SLOPED	5	10.24	10.44	Galv.	107.1	48.6	1	25FC
10620261	pro V 200 (1 Meter) 8" W x 39.4" L	0.0% NEUTRAL	5-0	10.44	10.44	Galv.	108.7	49.3	1	25FC
10620206	pro V 200 (1 Meter) 8" W x 39.4" L	0.5% SLOPED	6	10.44	10.63	Galv.	109.6	49.7	1	25FC
10620207	pro V 200 (1 Meter) 8" W x 39.4" L	0.5% SLOPED	7	10.63	10.83	Galv.	111.8	50.7	1	25FC
10620208	pro V 200 (1 Meter) 8" W x 39.4" L	0.5% SLOPED	8	10.83	11.02	Galv.	114.2	51.8	1	25FC
10620209	pro V 200 (1 Meter) 8" W x 39.4" L	0.5% SLOPED	9	11.02	11.22	Galv.	116.4	52.8	1	25FC
10620210	pro V 200 (1 Meter) 8" W x 39.4" L	0.5% SLOPED	10	11.22	11.42	Galv.	118.8	53.9	1	25FC
10620262	pro V 200 (1 Meter) 8" W x 39.4" L	0.0% NEUTRAL	10-0	11.42	11.42	Galv.	119.7	54.3	1	25FC
10620211	pro V 200 (1 Meter) 8" W x 39.4" L	0.5% SLOPED	11	11.42	11.61	Galv.	120.6	54.7	1	25FC
10620212	pro V 200 (1 Meter) 8" W x 39.4" L	0.5% SLOPED	12	11.61	11.81	Galv.	122.6	55.6	1	25FC
10620213	pro V 200 (1 Meter) 8" W x 39.4" L	0.5% SLOPED	13	11.81	12.01	Galv.	124.3	56.4	1	25FC
10620214	pro V 200 (1 Meter) 8" W x 39.4" L	0.5% SLOPED	14	12.01	12.2	Galv.	126.3	57.3	1	25FC
10620215	pro V 200 (1 Meter) 8" W x 39.4" L	0.5% SLOPED	15	12.2	12.4	Galv.	128.1	58.1	1	25FC
10620216	pro V 200 (1 Meter) 8" W x 39.4" L	0.5% SLOPED	16	12.4	12.6	Galv.	130.1	59	1	25FC
10620217	pro V 200 (1 Meter) 8" W x 39.4" L	0.5% SLOPED	17	12.6	12.8	Galv.	131.8	59.8	1	25FC
10620218	pro V 200 (1 Meter) 8" W x 39.4" L	0.5% SLOPED	18	12.8	12.99	Galv.	183.8	60.7	1	25FC
10620219	pro V 200 (1 Meter) 8" W x 39.4" L	0.5% SLOPED	19	12.99	13.19	Galv.	138.6	61.5	1	25FC
10620220	pro V 200 (1 Meter) 8" W x 39.4" L	0.5% SLOPED	20	13.19	13.38	Galv.	137.4	62.3	1	25FC
10620264	pro V 200 (1 Meter) 8" W x 39.4" L	0.0% NEUTRAL	20-0	13.38	13.38	Galv.	138.2	62.7	1	25FC

### Filcoten Channel Mini

10520202	Mini (1 Meter) 8" W x 39.4" L	0.0% NEUTRAL	100 mm	3.04	3.04	Galv.	45.42	20.6	1	25FC
----------	-------------------------------	--------------	--------	------	------	-------	-------	------	---	------

## 8" BG-FILCOTEN® pro V 200 Grates



Part No.	Description	Grate Type	Length	Heel Proof	ADA	Load Class
17020228	NW200 8" Grate	Galv. Perf.	1.0 Meter			C
17020229	NW200 8" Grate	Galv. Perf.	0.5 Meter			C

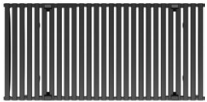



17020183	NW200 8" Grate	Ductile Kiaro Bar	0.5 Meter			D
----------	----------------	-------------------	-----------	---	---	---



17020184	NW200 8" Grate	Ductile Via Long	0.5 Meter			D
----------	----------------	------------------	-----------	---	--	---



17020104	NW200 8" Grate	Ductile Bar	0.5 Meter			D
17020105	NW200 8" Grate	Ductile Bar	0.5 Meter			E



17010183	NW200 8" Grate	Ductile Ville	0.5 Meter			E
----------	----------------	---------------	-----------	---	---	---

8" BG-FILCOTEN® pro V 200 Accessories

BG-FILCOTEN pro V 200 Sump Unit

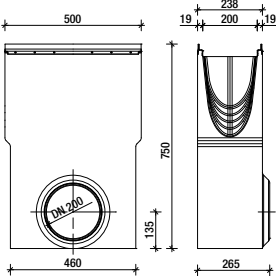

Part No.	Description	Material	Weight Ea. (lbs.)	Product Class
22512	pro V 200 Silt Bucket for Sump	Plastic	1.54	25FC
32089	pro V 200 Grate Vandal-Proof Device	Stainless Steel	0.22	25FC
70154	pro V 200 8" Pipe Connector for Catch Basin	Plastic	2.43	25FC
19020215	pro V 200 Closed End Cap	Galvanized Steel	0.88	25FC
19020216	pro V 200 End Cap with Outlet	Galvanized Steel	1.10	25FC
19020295	pro V 200 Step Connector Plate	Galvanized Steel	0.44	25FC
19020902	pro V 200 No Hub Bottom Outlet	Galvanized Steel	2.20	25FC
19020902	pro V 200 Rebar Support	Galvanized Steel	1.8	25FC
19021208	pro V 200 No Hub Bottom Outlet	Galvanized Steel	2.2	25FC
10620292	pro V 200 Catch Basin includes 10620290 catch basin and 22512 Sediment Bucket	Galvanized Rail	180.0	25FC

## 12" BG-FILCOTEN® pro V 300 Trench Drains

BG-FILCOTEN pro V 300 is ideal for large capacity water management. Available with a galvanized rail in both pre-sloped and neutra sections and up to load class E 600 (according to EN1433) Stainless steel rails and grates are also available.

Pro V 300 Galvanized Steel Trench Drain

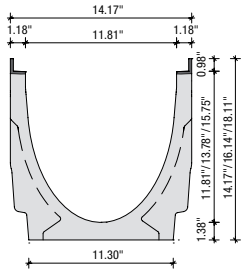

Part No.	Description	Slope	Depth	Invert		Rail	Weight (Less Grate)		Unit	Class
				In	Out		Lbs.	Kg.		
10630200	pro V 300 (1 Meter) 12" W x 39.4" L	0.0% NEUTRAL	0	12.79	12.79	Galv.	166.7	75.6	1	25FC
10630201	pro V 300 (1 Meter) 12" W x 39.4" L	0.5% SLOPED	1	12.79	12.99	Galv.	168.2	76.3	1	25FC
10630202	pro V 300 (1 Meter) 12" W x 39.4" L	0.5% SLOPED	2	12.99	13.19	Galv.	171.1	77.6	1	25FC
10630203	pro V 300 (1 Meter) 12" W x 39.4" L	0.5% SLOPED	3	13.19	13.38	Galv.	173.9	78.9	1	25FC
10630204	pro V 300 (1 Meter) 12" W x 39.4" L	0.5% SLOPED	4	13.38	13.58	Galv.	176.8	80.2	1	25FC
10630205	pro V 300 (1 Meter) 12" W x 39.4" L	0.5% SLOPED	5	13.58	13.78	Galv.	179.7	81.5	1	25FC
10630261	pro V 300 (1 Meter) 12" W x 39.4" L	0.0% NEUTRAL	5-0	13.78	13.78	Galv.	181	82.1	1	25FC
10630206	pro V 300 (1 Meter) 12" W x 39.4" L	0.5% SLOPED	6	13.78	13.98	Galv.	182.5	82.8	1	25FC
10630207	pro V 300 (1 Meter) 12" W x 39.4" L	0.5% SLOPED	7	13.98	14.17	Galv.	185.4	84.1	1	25FC
10630208	pro V 300 (1 Meter) 12" W x 39.4" L	0.5% SLOPED	8	14.17	14.37	Galv.	188.3	85.4	1	25FC
10630209	pro V 300 (1 Meter) 12" W x 39.4" L	0.5% SLOPED	9	14.37	14.57	Galv.	191.1	86.7	1	25FC
10630210	pro V 300 (1 Meter) 12" W x 39.4" L	0.5% SLOPED	10	14.57	14.76	Galv.	194	88	1	25FC
10630262	pro V 300 (1 Meter) 12" W x 39.4" L	0.0% NEUTRAL	10-0	14.76	14.76	Galv.	195.3	88.6	1	25FC
10630211	pro V 300 (1 Meter) 12" W x 39.4" L	0.5% SLOPED	11	14.76	14.96	Galv.	196.7	89.2	1	25FC
10630212	pro V 300 (1 Meter) 12" W x 39.4" L	0.5% SLOPED	12	14.96	15.16	Galv.	201.3	91.3	1	25FC
10630213	pro V 300 (1 Meter) 12" W x 39.4" L	0.5% SLOPED	13	15.16	15.35	Galv.	206.1	93.5	1	25FC
10630214	pro V 300 (1 Meter) 12" W x 39.4" L	0.5% SLOPED	14	15.35	15.55	Galv.	210.8	95.6	1	25FC
10630215	pro V 300 (1 Meter) 12" W x 39.4" L	0.5% SLOPED	15	15.55	15.75	Galv.	215.4	97.7	1	25FC
10630216	pro V 300 (1 Meter) 12" W x 39.4" L	0.5% SLOPED	16	15.75	15.94	Galv.	220.2	99.9	1	25FC
10630217	pro V 300 (1 Meter) 12" W x 39.4" L	0.5% SLOPED	17	15.94	16.14	Galv.	224.9	102	1	25FC
10630218	pro V 300 (1 Meter) 12" W x 39.4" L	0.5% SLOPED	18	16.14	16.34	Galv.	229.5	104.1	1	25FC
10630219	pro V 300 (1 Meter) 12" W x 39.4" L	0.5% SLOPED	19	16.34	16.54	Galv.	234.1	106.2	1	25FC
10630220	pro V 300 (1 Meter) 12" W x 39.4" L	0.5% SLOPED	20	16.54	16.73	Galv.	240	108.4	1	25FC
10630264	pro V 300 (1 Meter) 12" W x 39.4" L	0.0% NEUTRAL	20-0	16.73	16.73	Galv.	240.3	109	1	25FC

### Filcoten Channel Mini

10530200	Mini (1 Meter) 12" W x 39.4" L	0.0% NEUTRAL	100 mm	3.82	3.82	Galv.	83.5	37.9	1	25FC
----------	--------------------------------	--------------	--------	------	------	-------	------	------	---	------

12" BG-FILCOTEN® pro V 300 Grates

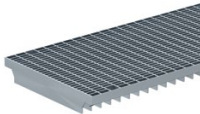

Part No.	Description	Grate Type	Length	Heel Proof	ADA	Load Class
17030222	NW300 12" Grate	Galv. Mesh	1 Meter			C
17030223	NW300 12" Grate	Galv. Mesh	0.5 Meter			C

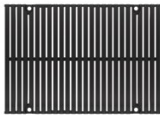

17030183	NW300 12" Grate	Ductile Kiaro Bar	0.5 Meter			D
----------	-----------------	-------------------	-----------	--	--	---

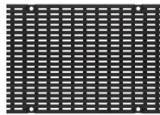

17030184	NW300 12" Grate	Ductile Via Long	0.5 Meter			D
----------	-----------------	------------------	-----------	--	--	---



17030103	NW300 12" Grate	Longitudinal Bar	0.5 Meter			E
----------	-----------------	------------------	-----------	--	--	---



17030180	NW300 12" Grate	Ductile Ville	0.5 Meter			E
----------	-----------------	---------------	-----------	--	--	---

All 12" grates will accept bolts, sold separately. See Accessories, page 70.

## 12" BG-FILCOTEN® pro V 300 Accessories

BG-FILCOTEN pro V 300  
Sump Kit with Silt Bucket

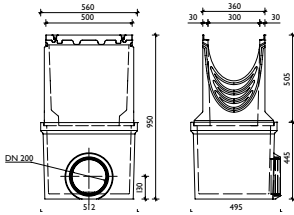

Part No.	Description	Material	Weight Ea. (lbs.)	Product Class
22213	pro V 300 Silt Bucket for Sump	Galvanized Steel	7.05	25FC
32110	pro V 300 Bolt and Nut for Locking Required for cast iron and ductile iron grates (4 per grate).	Galvanized Steel	0.22	25FC
19030213	pro V 300 Closed End Cap	Galvanized Steel	3.75	25FC
19030214	pro V 300 End Cap with Outlet	Galvanized Steel	3.53	25FC
19030290	pro V 300 Catch Basin End Cap Connector	Galvanized Steel	0.66	25FC
19030295	pro V 300 Step Connector Plate	Galvanized Steel	0.88	25FC
10630292	pro V 300 Catch Basin includes 10630290 Catch Basin Body and 22213 Sediment Bucket	Galvanized Rail	273.37	25FC

### LOAD RECOMMENDATION GUIDE



**NDS Class A**

- Loads of 1-60 psi.
- Recommended for pedestrians, bicycles and wheelchair traffic.



**NDS Class B**

- Loads of 61-175 psi.
- Recommended for medium-duty pneumatic tire traffic, autos and light trucks at speeds less than 20 m.p.h.



**NDS Class C**

- Loads of 176-325 psi.
- Recommended for heavy-duty pneumatic tire forklifts and tractor-trailers at speeds less than 20 m.p.h., H-20 rated.



**NDS Class D**

- Loads of 326-575 psi.
- Recommended for heavy-duty hard tire forklifts at speeds less than 20 m.p.h., H-20 rated.

### BG-FILCOTEN® Load Recommendation Guide—According to EN1433 Standards



**Class A**

- Max Design Load: 3,372 lbs.
- Bicyclists
- Pedestrians
- Planted Areas



**Class B**

- Max Design Load: 28,100 lbs.
- Parking Lots
- Pedestrians
- Delivery Vehicles



**Class C**

- Max Design Load: 56,200 lbs.
- Road Shoulders
- Curbs
- Parking Lots



**Class D**

- Max Design Load: 89,920 lbs.
- Pedestrian Zones
- Roadways
- Parking Lots
- Pneumatic Tire Traffic



**Class E**

- Max Design Load: 134,800 lbs.
- Military
- Industry
- High Wheel Loads

**Notes:** Some installations may require a concrete collar to meet load rating. Load ratings are based on encasing product in concrete. Product must be installed using NDS instructions.

Cast iron grates will oxidize over time and rust, forming an iron-oxide patina. The iron-oxide layer begins red-orange in color and ages to a deep, rich brown. This patina is tightly adhered and protects the iron beneath it from further oxidation. Iron grates with a rust patina are structurally sound and will last for decades.

Visit [ndspro.com/specifications](https://ndspro.com/specifications) for complete installation specifications, guidelines & details.

## Index, Channel Drains

Part No.	Page	Part No.	Page	Part No.	Page	Part No.	Page	Part No.	Page
229	45, 46, 48	548S	44	829	45, 46, 49, 51	8382	39	9371	41
230	39, 44, 47	550	44	830	52	8383	39	9372	41
234	47	551	42	831	52	8461	39	9373	41
240	45	552B	42	832	52	8462	39	9381	41
241	45	553PB	42	833	52	8463	39	9382	41
242	45	554	42	834	52	8471	39	9383	41
243	45	554CI	42	836	51	8472	39	13399	57, 64
244	45	554GY	42	837	51	8473	39	22213	70
245	47	554S	42	838	51	8481	39	22512	67
246	47	555	43	840	53	8501	39	22515	64
247	47	555CI	43	841	53	8502	39	32087	64
248	47	555GY	43	843	53	8503	39	32089	67
249	47	555S	43	844	53	8511	39	32110	70
251	45	629	58	846	42, 43	8512	39	70154	67
252	45	660	56	847	53	8513	39	10410200	60
252CI	45	661	56	849	53	8601	39	10410201	60
252GY	45	661LG	56	861	50	8651	39	10410202	60
252S	45	662	56	862	50	8652	39	10410203	60
253	46	663	56	864	49	8653	39	10410204	60
253CI	46	664	56	864DISPLAY	49	9206	40	10410205	60
253GY	46	665	56	864GMTL	49	9206GKIT	40	10410206	60
253S	46	710	48	864GMTLDISP	49	9206SKIT	40	10410207	60
254	45	712	48	885	53	9209	40	10410208	60
400	46	713	48	888	51	9209GRAY	40	10410209	60
400-10	46	714	48	2301	47	9209SAND	40	10410210	60
400-10MTL	46	764	48	2350	47	9209WHITE	40	10410211	60
400-10WH	46	800	50	2351	47	9241	40	10410212	60
500	43	812	50	2361	47	9242	40	10410213	60
500S	43	813	50	2371	47	9243	40	10410214	60
529	42, 44	814	49	2381	47	9247	41	10410215	60
532	44	815	49	5300	44	9248	41	10410216	60
533	44	816	49	5303	44	9250	41	10410217	60
540	42	817	49	5370	44	9251	40	10410218	60
541	42	818	49	5380	44	9252	40	10410219	60
542	42	819	49	5383	44	9253	40	10410220	60
543	42	820	50	8001	38	9261	40	10410261	60
544	42	821	50	8002	38	9262	40	10410262	60
546	44	822	50	8003	38	9263	40	10410264	60
546S	44	823	49	8301	39	9270	41	10410294	64
547	44	824	49	8302	39	9301	41	10410300	61
547S	44	826	49	8303	39	9302	41	10410301	61
548	44	828	49	8381	39	9303	41	10410302	61



We put water in its place™

Index, Channel Drains

Part No.	Page	Part No.	Page	Part No.	Page	Part No.	Page	Part No.	Page
10410303	61	10620217	65	17010204	62	19030295	70	DS-228	56
10410304	61	10620218	65	17010205	62	DS-091	54	DS-231	56
10410305	61	10620219	65	17010206	62	DS-091N	54	DS-232	56
10410306	61	10620220	65	17010207	62	DS-092	54	DS-232MG	59
10410307	61	10620261	65	17010220	62	DS-093	54	DS-240	55
10410308	61	10620262	65	17010221	62	DS-094	54	DS-340	55
10410309	61	10620264	65	17010228	62	DS-094N	54	DS-601	57
10410310	61	10620292	67	17010229	62	DS-095	54	DS-602	57
10410311	61	10630200	68	17010328	62	DS-096	54	DS-603	57
10410312	61	10630201	68	17010329	62	DS-097	54	DS-604	57
10410313	61	10630202	68	17010330	62	DS-097N	54	DS-609	57
10410314	61	10630203	68	17010401	62	DS-098	54	DS-610-KIARO	57
10410315	61	10630204	68	17010402	62	DS-099	54	DS-611-VIA	57
10410316	61	10630205	68	17020104	66	DS-100	54	DS-612-VILLE	57
10410317	61	10630206	68	17020105	66	DS-100N	54	DS-650	58
10410318	61	10630207	68	17020183	66	DS-101	54	DS-660MG	59
10410319	61	10630208	68	17020184	66	DS-102	54	DS-661LGMG	59
10410320	61	10630209	68	17020228	66	DS-103	54	DS-661MG	59
10410361	61	10630210	68	17020229	66	DS-103N	54	DS-662MG	59
10410362	61	10630211	68	17030103	69	DS-104	54	DS-663MG	59
10410364	61	10630212	68	17030180	69	DS-105	54	DS-664MG	59
10510200	60	10630213	68	17030183	69	DS-106	54	DS-670	56
10510201	60	10630214	68	17030184	69	DS-106N	54	DS-671	56
10520202	65	10630215	68	17030222	69	DS-107	54	DS-681LGMG	59
10530200	68	10630216	68	17030223	69	DS-108	54	DSRC	59
10620200	65	10630217	68	17111204	63	DS-109	54	DSRC-097	59
10620201	65	10630218	68	17111205	63	DS-109N	54	DSRC-100	59
10620202	65	10630219	68	17111206	63	DS-110	54	DSRC-103	59
10620203	65	10630220	68	17111304	63	DS-111	54	DSRC-106	59
10620204	65	10630261	68	17111305	63	DS-112	54	DS-SS-ST500	57
10620205	65	10630262	68	17111306	63	DS-112N	54	DS-SS-ST1000	57
10620206	65	10630264	68	19010400	64	DS-113	54	DS-SS-STMAINT	57
10620207	65	10630292	70	19010902	64	DS-114	54	DS-ST2	57
10620208	65	17010105	63	19011204	64	DS-122	58	DS-ST4	57
10620209	65	17010106	63	19020215	67	DS-123	58	DS-STMAINT	57
10620210	65	17010110	63	19020216	67	DS-126	58	PSRC-864	50
10620211	65	17010180	63	19020295	67	DS-200H	58		
10620212	65	17010183	63, 66	19020902	67	DS-221	56		
10620213	65	17010184	63	19021208	67	DS-224	58		
10620214	65	17010187	63	19030213	70	DS-226	56		
10620215	65	17010202	62	19030214	70	DS-226MG	59		
10620216	65	17010203	62	19030290	70	DS-227	58		

For Channel Drains Technical Information, Refer to Technical Specification documents at [ndspro.com/specifications](https://ndspro.com/specifications)



# Permeable Pavers

NDS Permeable Pavers provide an alternative solution to traditional paving methods. Creating a strong grass or gravel surface that can support heavy vehicles, they maintain permeable surface areas, eliminating or reducing stormwater runoff.



## Benefits of NDS® Permeable Pavers

### Greatest Compressive Strength\*.

Offering a high load-bearing capacity, NDS Permeable Pavers feature hexagonal cells that connect together to form a flexible grid system capable of handling significant structural loads.

### Easy Installation.

EZ Roll® products come in large rolls that are easily placed and clipped together. TuffTrack® features an integrated easy to assemble clip, that greatly reduces installation time.

### Reduced Maintenance.

Less expensive to maintain over time than traditional hardscaping and reduces demands put on landscape drainage systems.

### Environmentally Friendly.

NDS Permeable Pavers contribute to LEED credits and are made of up to 100% recycled plastic.

\*Compare the strength of NDS Permeable Pavers to the competition.

We put water in its place™

NDS® Permeable Pavers for a variety of applications.



TuffTrack® Grass Pavers

TuffTrack® Grass Pavers are the strongest paver on the market for grass applications. Manufactured in rigid 24" square panels it offers maximum strength and stabilization for support of heavy vehicles like fire trucks.



EZ Roll® Grass Pavers

EZ Roll® Grass Pavers feature hexagonal cells that protect the root zone and prevent soil compaction, allowing healthy grass to thrive in areas that would traditionally have impervious hardscaping installed.



EZ Roll® Gravel Pavers

EZ Roll® Gravel Pavers preserve permeability and help maintain the look and functionality of a gravel road. Made with 100% recycled materials, they also minimize surface water runoff and present an attractive and sustainable alternative to traditional concrete or asphalt.



NDS EZ Marker™ Parking Delineators

EZ Marker™ is a modular solution to outlining driving lanes, parking stalls, and fire lanes. After the pavers have been unrolled, pinned, and secured, EZ Marker™ snaps into the appropriate empty cells to outline whatever pattern necessary to properly direct vehicular traffic.

## TuffTrack® Grass Paver

TuffTrack® Grass Pavers are 24 in. x 24 in. rigid panels featuring a clip fastener designed for fast installation that easily connects without extra pieces or tools. The TuffTrack Grass Paver has a combined series of 120 nested hexagonal cells per paver cell with 12 connecting clips. This unique combination provides superior stability and durability.

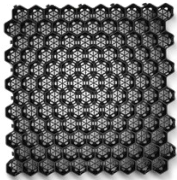

Part No.	Description	Color (Box/Cover)	Pallet Qty.	Wt. Ea. lbs.	Product Class
TT-24	24" x 24" TuffTrack® Grass Pavers	Black	1/132	4.35	55GP

## EZ Roll® Grass Pavers

EZ Roll® Grass Pavers are honeycombed rolled grass pavers that are comprised of 24 in. x 24 in x 1 in. panels. The product is made of up to 100% recycled HDPE material with UV inhibitors. Panels are available in pre-assembled rolls, and multiple panels and rolls easily connect together with a series of locking joints. EZ Roll Grass Pavers have an ultimate compression load rating of 53,683 psf "empty."

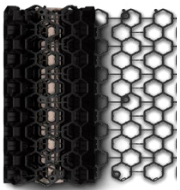

Part No.	Description	Color (Box/Cover)	Pallet Qty.	Wt. Ea. lbs.	Product Class
EZ4X24	EZ Roll® Grass Pavers, 3.96 ft. W x 24 ft. L roll, 95.01 sf total*	Black	6	55.44	55GP
EZ4X150	EZ Roll® Grass Pavers, 3.96 ft. W x 152 ft. L roll, 601.6 sf total*	Black	1	360.00	55GP

\*EZ Roll Grass Paver panels are 1" tall

### EZ Roll® Gravel Pavers

NDS EZ Roll® Gravel Pavers are a high quality injection molded, plastic rolled gravel paver structure of linked and nested honeycomb cells. The product is made from up to 100% recycled HPDE plastic with UV inhibitors. Pavers come in pre-assembled rolls, and a lateral snap lock latching system securely connects paver panels together to create an integral paver mat. Pavers must have an ultimate compression load rating of 53,683 psf (empty).

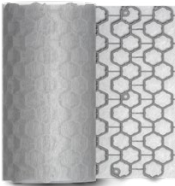

Part No.	Description	Color (Box/Cover)	Pallet Qty.	Wt. Ea. lbs.	Product Class
EZ4X24	EZ Roll® Grass Pavers, 3.96 ft. W x 24 ft. L roll, 95.01 sf total*	Black	6	55.44	55GP
EZ4X150	EZ Roll® Grass Pavers, 3.96 ft. W x 152 ft. L roll, 601.6 sf total*	Black	1	360.00	55GP

\*EZ Roll Gravel Paver panels are 1" tall, and include stakes

### EZ Marker™ Parking Delineators

EZ Marker™ Parking Delineators increase safety and organization by strategically directing parking lot traffic. Delineators are a great way to guide motorists around hazards and to their final parking destination. Used in conjunction with EZ Roll® Grass and Gravel Permeable Pavers they provide a simple and effective solution for managing parking lot traffic. EZ Marker is durable, tamper-resistant and built to last. Available in various colors to suit any traffic need including grass or gravel parking and fire line access.



Part No.	Description	Color
EZMARKER	EZ Marker™ Parking Delineator	White
EZMARKER-B	EZ Marker™ Parking Delineator	Blue
EZMARKER-Y	EZ Marker™ Parking Delineator	Yellow

### Index, Permeable Pavers

Part No.	Page	Part No.	Page	Part No.	Page	Part No.	Page	Part No.	Page
EZ4X24	76, 77								
EZ4X150	76, 77								
EZMARKER	77								
EZMARKER-B	77								
EZMARKER-Y	77								
TT-24	76								

For Permeable Paver Technical Information, Refer to Technical Specification documents at [ndspro.com/specifications](https://ndspro.com/specifications)



# Landscape

Root barrier products direct root growth from shrubs and trees downward, dramatically decreasing the roots' potential to clash with and penetrate nearby hardscapes, walls, or building foundations. The use of NDS root barriers for residential and non-residential landscapes protects many communities and homeowners against the high cost of reparations due to cracks in foundations and buckled sidewalks and driveways.



## Product Applications



### Protect Hardscapes

For residential or commercial planting areas, modular root barrier panels and sheet material creates a water and root barrier to prevent cracking, buckling and damage to pavement, roads, and building foundations.



### Landscaping

Protect newly planted trees in lawn or brush areas where mowing or trimming may cause damage to trunks.

We put water in its place™

## Modular EP Series Root Barrier Panels

Available in 12 in., 18 in., 24 in., 36 in., and 48 in. depths. Made from injection molded High Impact Polypropylene (HIPP) with a unique factory installed joiner strip that eases installation. EP Series Panels include a "T" top edge to prevent root overgrowth and an Anchor Lock™ external flange at the base to lock panels in the ground.

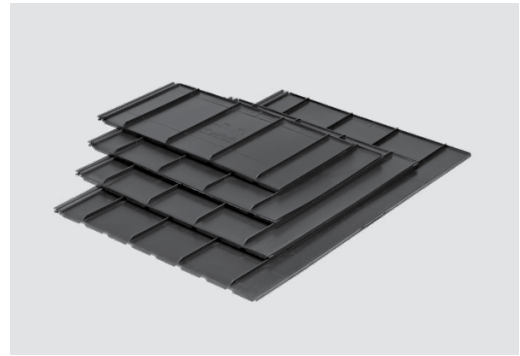

## Root Barrier Sheet Material

Available in 12 in., 18 in., 24 in., and 36 in. depths. Made from durable HDPE, Root Barrier Sheet Material creates a water and root barrier to prevent cost damage to pavements, roads, and building foundations caused by water and roots.



## Trunk Protector

Used around the base of trees to prevent damage from lawnmowers, edgers, and string trimmers. The coiled shape allows it to expand with the growth of the tree. It is vented which permits the tree to breathe and is notched at the base to accommodate root flare. NDS Trunk Protector is colored to help it blend with the natural shade of the tree. Each unit fits up to a 4" caliper tree; multiple units may be used for larger trees.



## Modular EP Series Root Barrier Panels

EP Series Root Barrier Panels by NDS include factory installed independent joiner strips. Each Barrier is a minimum of 0.090" thick and is made of up to 50% post consumer High Impact Polypropylene (HIPP) with U.V. inhibitors to ensure longevity. Barrier Panels have 1/2" raised vertical ribs running perpendicular to the panel and are 6" on center. All EP Series Panels feature a 3/8" wide "T" top edge and an external ground anchoring base flange that is 1/8" in width.

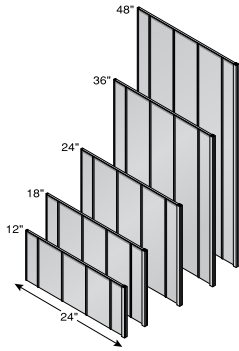

Part No.	Description	Color	Pkg. Qty.	Wt. Ea. lbs.	Product Class
EP-1250	12" x 24" Root Barrier Panel	Black	25	1.80	50LP
EP-1850	18" x 24" Root Barrier Panel	Black	25	1.56	50LP
EP-2450	24" x 24" Root Barrier Panel	Black	25	2.12	50LP
EP-3650	36" x 24" Root Barrier Panel	Black	25	3.20	50LP
RP-4850	48" x 24" Root Barrier Panel	Black	25	6.20	50LP

Includes 1 Joiner Strip per panel

## Modular EP Series Root Barrier Panels

Root Barrier Sheet Material by NDS is manufactured from up to 50% recycled HDPE with U.V. inhibitors with a thickness of 0.040-0.060". Barriers feature vertically integrated and flared molded 90° root-deflecting ribs that protrude 1/2" from wall and are placed 6-8" apart. A root impervious molded end provides easy assembly using staples or a sealant design to bind to HDPE (a dual-sided solvent-based tape).

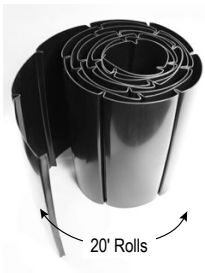

Part No.	Description	Color	Pkg. Qty.	Wt. Ea. lbs.	Product Class
SM-1220	12" x 20 ft. Roll	Black	1	10.00	50LP
SM-1820	18" x 20 ft. Roll	Black	1	14.00	50LP
SM-2420	24" x 20 ft. Roll	Black	1	18.00	50LP
SM-3620	36" x 20 ft. Roll	Black	1	22.00	50LP



### Trunk Protector

Trunk Protector by NDS is made of Low Density Linear Polyethylene (LDLPE) material with U.V. inhibitors to insure longevity. Trunk Protector measures 8" high, 12" wide and ± 0.050" thick. Slotted vents are 1" high by 1/4" wide, creating a serrated lower edge on the bottom row.

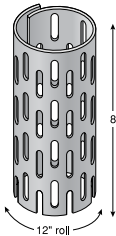

Part No.	Description	Color	Pkg. Qty.	Wt. Ea. lbs.	Product Class
TP-128	Trunk Protector	Gray	50	0.16	50LP

### Index, Landscape Products

Part No.	Page	Part No.	Page	Part No.	Page	Part No.	Page	Part No.	Page
EP-1250	80	SM-2420	80						
EP-1850	80	SM-3620	80						
EP-2450	80	TP-128	81						
EP-3650	80								
RP-4850	80								
SM-1220	80								
SM-1820	80								

For Landscape Technical Information, Refer to Technical Specification documents at [ndspro.com/specifications](https://ndspro.com/specifications)



# Irrigation

Efficient drip irrigation products offer complete, system-oriented watering solutions for the Landscape industry. Product offering includes dripline, drip emitters, multioutlet devices, bubblers, micro-sprays, misters, tubing, fittings, stakes, regulators, valves and filters.



## Product Applications



### Sparse Landscape Planting

Efficient solutions deliver water directly to plants, shrubs and tree canopy areas, which includes landscapes around high-traffic areas, slopes, medians and narrow planting beds.



### Dense Landscape Planting

Precise dripline solutions deliver water to dense planting, which requires irrigation of the entire landscape area.



### Vegetable Gardens

Cost-effective solution delivers water to vegetable gardens, flower and fruit trees.



**Point of Connection**

NDS offers timers, valves, pressure regulators, and filters that connect to a hose or main irrigation line. Conversion kits allow sprinkler system conversion.



**Blank Tubing**

Available in a range of sizes from 1/8 in. (0.125 in. ID X 0.185 in. OD) to 1 in. (1.060 in. ID X 1.200 in. OD) and various colors.



**Dripline**

Built-in emitters (check valve, pressure compensating and non-pressure compensating) deliver water along the entire dripline length.



**Fittings**

Adapters, insert, compression and Smart Loc™ fittings connect sections of tubing or dripline together as well as connect to irrigation piping system.



**Single and Multioutlet Emitters**

Point source emitters, bubblers, micro-sprays in a variety of flow rates. Multioutlet emitters conveniently water a group of plants.



**Accessories**

Risers, stakes and staples support and enhance the performance of drip irrigation systems.

## Point of Connection

### Hose Bib Timer



Part No.	Description	Color	Bag Qty./ Box Qty.	Weight Ea. (lbs.)	Product Class
A675CT	Battery Hose Bib Timer	Blue	1/10	1.25	21DI

### Universal Conversion Kit & Cap-Off, Patented



Part No.	Description	Color	Bag Qty./ Box Qty.	Weight Ea. (lbs.)	Product Class
FR2 17-710	Spray-to-Drip Conversion Kit 17mm-0.710	Black	1	0.3208	21DI
CAP POP/5	Universal Cap-Off	Black	5	0.028	21DI
CAP POP/25	Universal Cap-Off	Black	25	0.0264	21DI

### Pressure-Regulating Wye Filter



Part No.	Description	Color	Bag Qty./ Box Qty.	Weight Ea. (lbs.)	Product Class
PRYF 30	Pressure Regulating Filters, 3/4" MPT, 30 PSI, 200 mesh	Black	1/5	0.25	21DI
PRYF 40	Pressure Regulating Filters, 1" MPT, 40 PSI, 200 mesh	Black	1/5	0.30	21DI

### Control Zone Kits



Part No.	Description	Bag Qty./ Box Qty.	Weight Ea. (lbs.)	Product Class
CZK 100-30F	1" Control Zone Kit with 30 PSI Pressure Regulating Filter and Flow Control	1/10	21DI	21DI
CZK 100-40F	1" Control Zone Kit with 40 PSI Pressure Regulating Filter and Flow Control	1/10	21DI	21DI

## Drip Zone Kit

**Reducing Bushing**



1 in. THD  
3/4 in. THD  
1 in. MPT x 3/4 in. Female

**3/4 in. Wye Filter  
YS 75**



**30 PSI Pressure Regulator  
PR 30R**



**Smart Loc™  
Multidiameter Adapter  
CMAP 75-18**

OR

**MIPT 710 Series Adapter  
CMAP 710**

OR

**MIPT 700 Series Adapter  
CMAP 700**



**Flow Direction** →

**Features**

- All parts in one easy to install kit
- Fits .068 in. – .710 in. OD PE Tubing
- 3/4 in. or 1 in. inlet
- 150 mesh filter prevents debris from entering the system
- 30 PSI regulator

Part No.	Description	Bag Qty./ Box Qty.	Weight per 100 (lbs.)	Product Class
DZK700/710	Drip Zone Kit: 150 Mesh Filter, 30 PSI Regulator, 1-8 gpm Flow (Fits .680" – .710" OD Tubing Outlet 1" and 3/4" MIPT Inlet)	1/10	0.76	21DI

## "Y" Strainers



Part No.	Description	Color	Bag Qty./ Box Qty.	Weight Ea. (lbs.)	Product Class
YS 75	"Y" Filter, 3/4" MIPT, with 150 Mesh Polyester Screen Element (10 gpm Capacity, 150 PSI Max. Pressure)	Black	1/50	33.1	21DI
YSV 75	"Y" Filter, 3/4" MIPT, with 150 Mesh Polyester Screen Element, Includes Flush Valve (10 gpm Capacity, 150 PSI Max. Pressure)	Black	1/50	35.6	21DI
YSVS 75	"Y" Filter, 3/4" MIPT, with 150 Mesh Stainless Steel Screen Element, Includes Flush Valve (10 gpm Capacity, 150 PSI Max. Pressure)	Black	1/50	36.5	21DI
YS 100	"Y" Filter, 1" MIPT, with 150 Mesh Polyester Screen Element (10 gpm Capacity, 150 PSI Max. Pressure)	Black	1/50	36.8	21DI
YSV 100	"Y" Filter, 1" MIPT, with 150 Mesh Polyester Screen Element, Includes Flush Valve (10 gpm Capacity, 150 PSI Max. Pressure)	Black	1/50	39.0	21DI
YSVS 100	"Y" Filter, 1" MIPT, with 150 Mesh Stainless Steel Screen Element, Includes Flush Valve (10 gpm Capacity, 150 PSI Max. Pressure)	Black	1/50	39.7	21DI

## Pressure Regulators

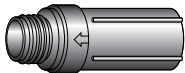
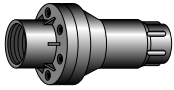

Part No.	Description	Color	Bag Qty./ Box Qty.	Weight Ea. (lbs.)	Product Class
PR 20	20 PSI, 3/4" FIPT Pressure Regulator (0.1 – 8 gpm Flow Range)	Black	10/50	31.0	21DI
PR 30	30 PSI, 3/4" FIPT Pressure Regulator (0.1 – 8 gpm Flow Range)	Black	10/50	31.0	21DI
PRM 30	30 PSI, 3/4" FIPT Pressure Regulator (2 – 20 gpm Flow Range)	Black	10/50	31.0	21DI

## Swing Joints

Specifications: PVC, Rated @315 PSI @ 72° F



PVC Sch. 80  
Swing Assembly  
Gray

Part No.	Description	Color (Box/Cover)	Pallet Qty.	Product Class
<b>PVC Sch. 80 Swing Assembly</b>				
TSA-0500-ST	1/2" S x M	Gray	60	42TS
TSA-0500-TT	1/2" M x M	Gray	60	42TS
TSA-0750-ST	3/4" S x M	Gray	50	42TS
TSA-0750-TT	3/4" M x M	Gray	50	42TS
TSA-1000-ST	1" S x M	Gray	25	42TS
TSA-1000-TT	1" M x M	Gray	25	42TS
TSA-1500-TT	1-1/2" M x M	Gray	15	42TS

### Landscape Sprinkler Products

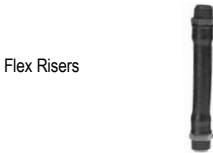

Part No.	Description	Ctn. Qty.	Product Class	Specifications
<b>Cut-Off Risers</b>				
FCO-0500	1/2" x 6" Flex Cut-Off	50	42LS	Rated @ 70 PSI @ 72°F
<b>Flex Risers</b>				
FR-0500-4	1/2" x 4" MIPT x MIPT Flex Riser	100	42LS	Rated @ 70 PSI @ 72°F
FR-0500-4F	1/2" x 4" MPT x FPT Flex Riser	100	42LS	
FR-0500-6	1/2" x 6" MIPT x MIPT Flex Riser	100	42LS	
FR-0750-6	3/4" x 6" MIPT x MIPT Flex Riser	50	42LS	
<b>Swing Pipe Fittings</b>				
FPA-0500	Swing Pipe Adapter .490BARB x 1/2"	50	42LS	Rated @ 70 PSI @ 72°F
FPA-0750	3/4" Swing Pipe Adapter	250	42LS	
FPC-0490	.49" Swing Pipe Connector	250	42LS	
FPE-0500	1/2" Swing Pipe Elbow	400	42LS	
FPE-0750	3/4" Swing Pipe Elbow	250	42LS	
FPT-0500	1/2" Swing Pipe Tee	500	42LS	
<b>Shrub Adapter</b>				
SAM-0500	1/2" Male Sprinkler Adapter	50	42LS	Rated @ 70 PSI @ 72°F

## Dripline

### 17mm Dura Flo™ CV

**Specifications:** Refer to Technical Specifications Document for Flowcharts and Run Length Information at [ndspro.com/specifications](https://ndspro.com/specifications)

**Shrink Wrapped Packaging**

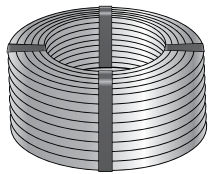

0.660" OD  
Inline Check Valve

Part No.	Description	Color	Coil Size/Type	Weight per 100' (lbs.)	Product Class
SFCV-BR-6212-01S	0.6 gph, 17mm Dura Flo™ Inline Check Valve Dripline (0.560" ID x 0.660" OD), 12" spacing	Brown	100'/ Wrapped Coil	3.3	21DF
SFCV-BR-6212-025S	0.6 gph, 17mm Dura Flo™ Inline Check Valve Dripline (0.560" ID x 0.660" OD), 12" spacing	Brown	250'/ Wrapped Coil	3.3	21DF
SFCV-BR-6212-05S	0.6 gph, 17mm Dura Flo™ Inline Check Valve Dripline (0.560" ID x 0.660" OD), 12" spacing	Brown	500'/ Wrapped Coil	3.3	21DF
SFCV-BR-6218-025S	0.6 gph, 17mm Dura Flo™ Inline Check Valve Dripline (0.560" ID x 0.660" OD), 18" spacing	Brown	250'/ Wrapped Coil	3.3	21DF
SFCV-BR-6218-05S	0.6 gph, 17mm Dura Flo™ Inline Check Valve Dripline (0.560" ID x 0.660" OD), 18" spacing	Brown	500'/ Wrapped Coil	3.3	21DF
SFCV-BR-6412-01S	0.9 gph, 17mm Dura Flo™ Inline Check Valve Dripline (0.560" ID x 0.660" OD), 12" spacing	Brown	100'/ Wrapped Coil	3.3	21DF
SFCV-BR-6412-025S	0.9 gph, 17mm Dura Flo™ Inline Check Valve Dripline (0.560" ID x 0.660" OD), 12" spacing	Brown	250'/ Wrapped Coil	3.3	21DF
SFCV-BR-6412-05S	0.9 gph, 17mm Dura Flo™ Inline Check Valve Dripline (0.560" ID x 0.660" OD), 12" spacing	Brown	500'/ Wrapped Coil	3.3	21DF
SFCV-BR-6418-01S	0.9 gph, 17mm Dura Flo™ Inline Check Valve Dripline (0.560" ID x 0.660" OD), 18" spacing	Brown	100'/ Wrapped Coil	3.3	21DF
SFCV-BR-6418-025S	0.9 gph, 17mm Dura Flo™ Inline Check Valve Dripline (0.560" ID x 0.660" OD), 18" spacing	Brown	250'/ Wrapped Coil	3.3	21DF
SFCV-BR-6418-05S	0.9 gph, 17mm Dura Flo™ Inline Check Valve Dripline (0.560" ID x 0.660" OD), 18" spacing	Brown	500'/ Wrapped Coil	3.3	21DF
SFCV-BR-6424-05S	0.9 gph, 17mm Dura Flo™ Inline Check Valve Dripline (0.560" ID x 0.660" OD), 24" spacing	Brown	500'/ Wrapped Coil	3.3	21DF

Notes: 1,000' Coils are Available Made to Order.  
Brown 17mm Tubing with no emitters can be found on page 108 – See A 660BR SKUs.



# 17mm Dura Flo™ PC

**Specifications:** Refer to Technical Specifications Document for Flowcharts and Run Length Information at [ndspro.com/specifications](https://ndspro.com/specifications)

**Shrink Wrapped Packaging**



0.660" OD  
Pressure Compensative

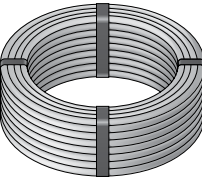

0.660" OD  
Pressure Compensative

Part No.	Description	Color	Coil Size/Type	Weight per 100' (lbs.)	Product Class
SFPC-BR-17212-025S	1/2 gph, 17mm Dura Flo™ Pressure Compensating Dripline (0.560" ID x 0.660" OD), 12" spacing	Brown	250'/ Wrapped Coil	4.1	21DF
SFPC-BR-17212-05S	1/2 gph, 17mm Dura Flo™ Pressure Compensating Dripline (0.560" ID x 0.660" OD), 12" spacing	Brown	500'/ Wrapped Coil	4.1	21DF
SFPC-BR-17218-025S	1/2 gph, 17mm Dura Flo™ Pressure Compensating Dripline (0.560" ID x 0.660" OD), 18" spacing	Brown	250'/ Wrapped Coil	3.9	21DF
SFPC-BR-17412-01S	1 gph, 17mm Dura Flo™ Pressure Compensating Dripline (0.560" ID x 0.660" OD), 12" spacing	Brown	100'/ Wrapped Coil	3.3	21DF
SFPC-BR-17412-025S	1 gph, 17mm Dura Flo™ Pressure Compensating Dripline (0.560" ID x 0.660" OD), 12" spacing	Brown	250'/ Wrapped Coil	4.1	21DF
SFPC-BR-17412-05S	1 gph, 17mm Dura Flo™ Pressure Compensating Dripline (0.560" ID x 0.660" OD), 12" spacing	Brown	500'/ Wrapped Coil	4.1	21df
SFPC-BR-17418-025S	1 gph, 17mm Dura Flo™ Pressure Compensating Dripline (0.560" ID x 0.660" OD), 18" spacing	Brown	250'/ Wrapped Coil	4.7	21DF

## 16mm Dura Flo™ PC

**Specifications:** Refer to Technical Specifications Document for Flowcharts and Run Length Information at [ndspro.com/specifications](https://ndspro.com/specifications)



0.640" OD  
Pressure Compensative

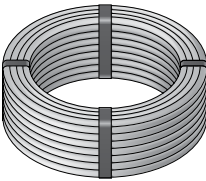

0.640" OD  
Pressure Compensative

Part No.	Description	Color	Coil Size/Type	Weight per 100' (lbs.)	Product Class
SFPC-BR-6212-025	1/2 gph, 16mm Dura Flo™ Pressure Compensating Dripline (0.550" ID x 0.640" OD), 12" spacing	Brown	250'/Coil	4.0	21DF
SFPC-BR-6212-05	1/2 gph, 16mm Dura Flo™ Pressure Compensating Dripline (0.550" ID x 0.640" OD), 12" spacing	Brown	500'/Coil	4.0	21DF
SFPC-BL-6412-01	1 gph, 16mm Dura Flo™ Pressure Compensating Dripline (0.550" ID x 0.640" OD), 12" spacing	Black	100'/Coil	4.0	21DF
SFPC-BL-6412-05	1 gph, 16mm Dura Flo™ Pressure Compensating Dripline (0.550" ID x 0.640" OD), 12" spacing	Black	500'/Coil	3.3	21DF
SFPC-BR-6412-01	1 gph, 16mm Dura Flo™ Pressure Compensating Dripline (0.550" ID x 0.640" OD), 12" spacing	Brown	100'/Coil	4.0	21DF
SFPC-BR-6412-025	1 gph, 16mm Dura Flo™ Pressure Compensating Dripline (0.550" ID x 0.640" OD), 12" spacing	Brown	250'/Coil	4.0	21DF
SFPC-BR-6412-05	1 gph, 16mm Dura Flo™ Pressure Compensating Dripline (0.550" ID x 0.640" OD), 12" spacing	Brown	500'/Coil	4.0	21DF
SFPC-BR-6418-01	1 gph, 16mm Dura Flo™ Pressure Compensating Dripline (0.550" ID x 0.640" OD), 18" spacing	Brown	100'/Coil	3.8	21DF
SFPC-BR-6418-025	1 gph, 16mm Dura Flo™ Pressure Compensating Dripline (0.550" ID x 0.640" OD), 18" spacing	Brown	250'/Coil	3.8	21DF
SFPC-BL-6418-05	1 gph, 16mm Dura Flo™ Pressure Compensating Dripline (0.550" ID x 0.640" OD), 18" spacing	Black	500'/Coil	3.8	21DF
SFPC-BR-6418-05	1 gph, 16mm Dura Flo™ Pressure Compensating Dripline (0.550" ID x 0.640" OD), 18" spacing	Brown	500'/Coil	3.8	21DF

## 18mm Dura Flo™ PC

**Specifications:** Refer to Technical Specifications Document for Flowcharts and Run Length Information at [ndspro.com/specifications](https://ndspro.com/specifications)



0.700" OD  
Pressure Compensative

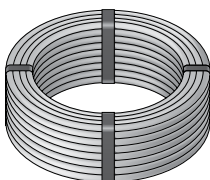

0.700" OD  
Pressure Compensative

Part No.	Description	Color	Coil Size/Type	Weight per 100' (lbs.)	Product Class
SFPC-BL-7212-01	1/2 gph, 18mm Dura Flo™ Pressure Compensating Dripline (0.600" ID x 0.700" OD), 12" spacing	Black	100'/Coil	4.7	21DF
SFPC-BR-7212-01	1/2 gph, 18mm Dura Flo™ Pressure Compensating Dripline (0.600" ID x 0.700" OD), 12" spacing	Brown	100'/Coil	4.7	21DF
SFPC-BL-7212-05	1/2 gph, 18mm Dura Flo™ Pressure Compensating Dripline (0.600" ID x 0.700" OD), 12" spacing	Black	500'/Coil	4.7	21DF
SFPC-BL-7412-01	1 gph, 18mm Dura Flo™ Pressure Compensating Dripline (0.600" ID x 0.700" OD), 12" spacing	Black	100'/Coil	4.7	21DF
SFPC-BR-7412-01	1 gph, 18mm Dura Flo™ Pressure Compensating Dripline (0.600" ID x 0.700" OD), 12" spacing	Brown	100'/Coil	4.7	21DF
SFPC-BL-7412-05	1 gph, 18mm Dura Flo™ Pressure Compensating Dripline (0.600" ID x 0.700" OD), 12" spacing	Black	500'/Coil	4.7	21DF
SFPC-BR-7412-05	1 gph, 18mm Dura Flo™ Pressure Compensating Dripline (0.600" ID x 0.700" OD), 12" spacing	Brown	500'/Coil	4.7	21DF
SFPC-BL-7418-05	1 gph, 18mm Dura Flo™ Pressure Compensating Dripline (0.600" ID x 0.700" OD), 18" spacing	Black	500'/Coil	4.5	21DF
SFPC-BR-7418-05	1 gph, 18mm Dura Flo™ Pressure Compensating Dripline (0.600" ID x 0.700" OD), 18" spacing	Brown	500'/Coil	4.5	21DF

## 18mm Dura Flo™ CV

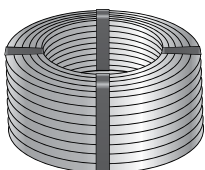

0.700" OD  
Inline Check Valve

Part No.	Description	Color	Coil Size/Type	Weight per 100' (lbs.)	Product Class
SFCV-BR-7212-01	0.6 gph, 18mm Dura Flo™ Inline Check Valve Dripline (0.600" ID x 0.700" OD), 12" spacing	Brown	100'/Coil	3.3	21DF
SFCV-BR-7412-01	0.9 gph, 18mm Dura Flo™ Inline Check Valve Dripline (0.600" ID x 0.700" OD), 12" spacing	Brown	100'/Coil	3.3	21DF
SFCV-BR-7412-025	0.9 gph, 18mm Dura Flo™ Inline Check Valve Dripline (0.600" ID x 0.700" OD), 12" spacing	Brown	250'/Coil	3.3	21DF
SFCV-BR-7412-10	0.9 gph, 18mm Dura Flo™ Inline Check Valve Dripline (0.600" ID x 0.700" OD), 12" spacing	Brown	1,000'/Coil	3.3	21DF

# 1/4" Dura Flo™ Jr

**Specifications:** Refer to Technical Specifications Document for Flowcharts and Run Length Information at [ndspro.com/specifications](https://ndspro.com/specifications)

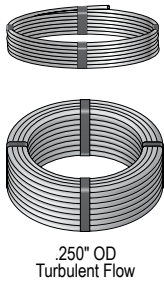

Part No.	Description	Color	Coil Size/Type	Weight per 100' (lbs.)	Product Class
SFJR-BL-06-01	1/2 gph, 1/4" Dura Flo™ Jr Dripperline (0.170" ID x 0.250" OD) 6" spacing	Black	100'/Coil	1.2	21DF
SFJR-BL-06-10	1/2 gph, 1/4" Dura Flo™ Jr Dripperline (0.170" ID x 0.250" OD) 6" spacing	Black	1,000'/Spool	1.2	21DF
SFJR-BL-12-01	1/2 gph, 1/4" Dura Flo™ Jr Dripperline (0.170" ID x 0.250" OD) 12" spacing	Black	100'/Coil	1.1	21DF
SFJR-BR-06-01	1/2 gph, 1/4" Dura Flo™ Jr Dripperline (0.170" ID x 0.250" OD) 6" spacing	Brown	100'/Coil	1.2	21DF
SFJR-BR-12-01	1/2 gph, 1/4" Dura Flo™ Jr Dripperline (0.170" ID x 0.250" OD) 12" spacing	Brown	100'/Coil	1.1	21DF

Note: Non-PC Emitter.

## Dura Flo™ HD – Heavy Duty for Commercial Applications

Dura Flo™ HD is the only 3/4 in. Heavy Duty dripline solution designed for commercial applications, offering superior durability vs. traditional PVC systems, with the design flexibility and the water efficiency of drip irrigation. Ideal for sparse uniform planting, Dura Flo™ HD offers unique spacing configurations.

### Dura Flo™ HD emitter flow rate and spacing

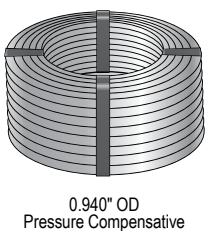
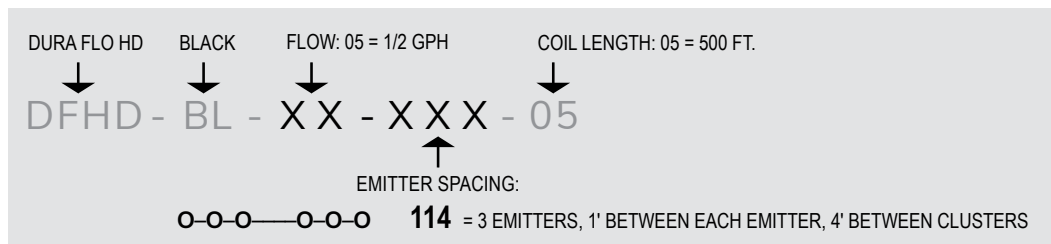

Part No.	Description	Color	Coil Size/Type	Weight per 100' (lbs.)	Product Class
DFHD-BL-10-114-05	1 gph, Dura Flo™ HD Dripline (0.790" ID x 0.940" OD), see above for spacing*	Black	500'/Coil	6.4	21DF

\*This product is made-to-order – please contact your local NDS representative for more information.

## Single Outlet Devices

### Pressure Compensating

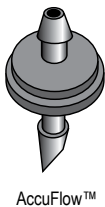

Part No.	Description	Color	Bag Qty./ Box Qty.	Weight per 100 (lbs.)	Product Class
<b>AccuFlow™</b>					
AFPC 5	1/2 gph Pressure Compensating AccuFlow™ Emitter	Blue	100/N/A	N/A	21DI
AFPC 10	1 gph Pressure Compensating AccuFlow™ Emitter	Black	100/N/A	N/A	21DI
AFPC 20	2 gph Pressure Compensating AccuFlow™ Emitter	Red	100/N/A	N/A	21DI
AFPC 20/25	2 gph Pressure Compensating AccuFlow™ Emitter	Red	25/N/A	N/A	21DI
AFPC 50	5 gph Pressure Compensating AccuFlow™ Emitter	Tan	100/N/A	N/A	21DI

### Non-Pressure Compensating

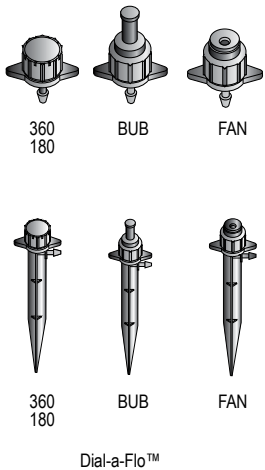

Part No.	Description	Color	Bag Qty./ Box Qty.	Weight per 100 (lbs.)	Product Class
<b>Dial-a-Flo™</b>					
DAFB 360	360°, 8 Stream, 0-10 gph, 1/4" Barbed, Adjustable Dial-a-Flo™ Emitter	Black	100/2,500	0.5	21DI
DAFB 180	180°, 5 Stream, 0-10 gph, 1/4" Barbed, Adjustable Dial-a-Flo™ Emitter	Black	100/2,500	0.5	21DI
DAFB FAN	360°, Fan Spray, 0-20 gph, 1/4" Barbed, Adjustable Dial-a-Flo™ Emitter	Black	100/2,500	0.6	21DI
DAFB BUB	Umbrella Bubbler, 0-25 gph, 1/4" Barbed, Adjustable Dial-a-Flo™ Emitter	Black	100/2,500	0.7	21DI
DAFT 360	360°, 8 Stream, 0-10 gph, 10/32 NDS Threads, Adjustable Dial-a-Flo™ Emitter	Black	100/2,500	0.6	21DI
DAFT 180	180°, 5 Stream, 0-10 gph, 10/32 NDS Threads, Adjustable Dial-a-Flo™ Emitter	Black	100/2,500	0.6	21DI
DAFT FAN	360°, Fan Spray, 0-20 gph, 10/32 NDS Threads, Adjustable Dial-a-Flo™ Emitter	Black	100/2,500	0.7	21DI
DAFT BUB	Umbrella Bubbler, 0-25 gph, 10/32 NDS Threads, Adjustable Dial-a-Flo™ Emitter	Black	100/2,500	0.8	21DI
DAFS 360	360°, 8 Stream, 0-10 gph, Adjustable Dial-a-Flo™ Emitter with 6" Stake	Black	100/1,000	1.4	21DI
DAFS 180	180°, 5 Stream, 0-10 gph, Adjustable Dial-a-Flo™ Emitter with 6" Stake	Black	100/1,000	1.4	21DI
DAFS FAN	360°, Fan Spray, 0-20 gph, Adjustable Dial-a-Flo™ Emitter with 6" Stake	Black	100/1,000	1.4	21DI
DAFS BUB	Umbrella Bubbler, 0-25 gph, Adjustable Dial-a-Flo™ Emitter with 6" Stake	Black	100/1,000	1.5	21DI

## Non-Pressure Compensating

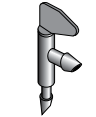

Super-Flo™

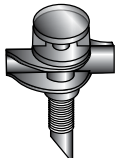
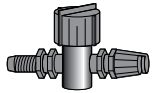
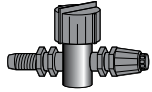

Hydro-Flo™

Part No.	Description	Color	Bag Qty./ Box Qty.	Weight per 100 (lbs.)	Product Class
<b>Super-Flo™</b>					
TAE 10	1 gph, Laminar Flow, Take-Apart Super-Flo™ Emitter	Black	100/2,000	0.4	21DI
TAE 20	2 gph, Laminar Flow, Take-Apart Super-Flo™ Emitter	Green	100/2,000	0.4	21DI
TAE 40	4 gph, Laminar Flow, Take-Apart Super-Flo™ Emitter	Yellow	100/2,000	0.4	21DI
<b>Hydro-Flo™</b>					
VF 360	0-25 gph, Hydro-Flo™ Adjustable Jet (360° Pattern – Stream Spray, 10-32 NPT Inlet)*	Black	100/500	0.5	21DI
VF 180	0-25 gph, Hydro-Flo™ Adjustable Jet (180° Pattern – Fan Spray, 10-32 NPT Inlet)*	Black	100/500	0.5	21DI
VF 90	0-25 gph, Hydro-Flo™ Adjustable Jet (90° Pattern – Fan Spray, 10-32 NPT Inlet)*	Black	100/500	0.5	21DI
TF 436	0.040" Nozzle, 360° Fan Spray Single-Piece Hydro-Flo™ Jet	Blue	100/2,500	0.1	21DI
TF 536	0.050" Nozzle, 360° Fan Spray Single-Piece Hydro-Flo™ Jet	Green	100/2,500	0.1	21DI
TF 636	0.060" Nozzle, 360° Fan Spray Single-Piece Hydro-Flo™ Jet	Red	100/2,500	0.1	21DI
TF 418	0.040" Nozzle, 180° Fan Spray Single-Piece Hydro-Flo™ Jet	Blue	100/2,500	0.1	21DI
TF 518	0.050" Nozzle, 180° Fan Spray Single-Piece Hydro-Flo™ Jet	Green	100/2,500	0.1	21DI
TF 618	0.060" Nozzle, 180° Fan Spray Single-Piece Hydro-Flo™ Jet	Red	100/2,500	0.1	21DI
TF 49	0.040" Nozzle, 90° Fan Spray Single-Piece Hydro-Flo™ Jet	Blue	100/2,500	0.1	21DI
TF 59	0.050" Nozzle, 90° Fan Spray Single-Piece Hydro-Flo™ Jet	Green	100/2,500	0.1	21DI
TF 69	0.060" Nozzle, 90° Fan Spray Single-Piece Hydro-Flo™ Jet	Red	100/2,500	0.1	21DI

### Non-Pressure Compensating



Micro-Flo™



Tri-Flo™

Part No.	Description	Color	Bag Qty./ Box Qty.	Weight per 100 (lbs.)	Product Class
<b>Micro-Flo™</b>					
MFA	0-25 gph, Micro-Flo™ Adjustable Micro-Sprinkler with Shutoff (10-32 NPT Inlet)	Red	50/300	1.2	21DI
<b>Tri-Flo™</b>					
TFS 9	3 Flow Tri-Flo™ Spraystick, 90° Pattern*	Blue	100/2,000	0.6	21DI
TFS 16	3 Flow Tri-Flo™ Spraystick, 160° Pattern*	Green	100/2,000	0.7	21Dli

\*Use with 1/8" tubing A 185, see page 107. Not recommended for vinyl tubing

### RootWise™ Watering Pad

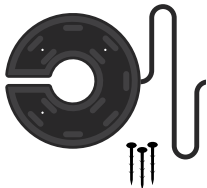

Part No.	Description	Color	Bag Qty./ Box Qty.	Product Class
RW16N1	16" Diameter 360° Watering Pad	Black	1/8	21DI

## Risers & Accessories

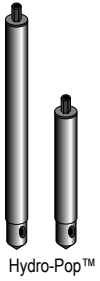

Part No.	Description	Color	Bag Qty./ Box Qty.	Weight per 100 (lbs.)	Product Class
<b>Hydro-Pop™</b>					
HYP 250	Hydro-Pop™ Pop-up Riser with 1/4" Compression Fit Inlet Maximum 9" Extension (Minimum Pressure Required = 15 PSI)	Black	25/100	12.9	21DI
HYPJ 250	Hydro-Pop™ Pop-up Riser with 1/4" Compression Fit Inlet Maximum 5" Extension (Minimum Pressure Required = 15 PSI)	Black	25/150	9.7	21DI
R 12	12" Riser Extension (0.160" ID x 0.300" OD)	Black	100/1,000	2.1	21DI
RATT 12	12" Riser (0.160" ID) with Threaded Adapter	Black	100/1,000	2.2	21DI
RABB 8	8" Riser (.160" ID) with Barbed Adapter	Black	100/N/A	1.5	21DI
RABT 12	12" Riser (0.160" ID) with Barbed Adapter	Black	100/1,000	2.2	21DI
S5R6	6" Riser (R6) Pre-assembled onto Elbow Stake (S5)	Black	100/400	2.5	21DI
S5R8	8" Riser (R8) Pre-assembled onto Elbow Stake (S5)	Black	100/400	2.8	21DI
S5R12	12" Riser (R12) Pre-assembled onto Elbow Stake (S5)	Black	100/600	3.6	21DI

## Stake Assemblies

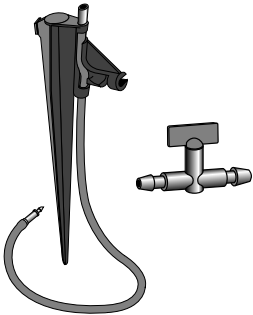

Part No.	Description	Color	Bag Qty./ Box Qty.	Weight per 100 (lbs.)	Product Class
TA 24-4	Assembly Comprising 24" Vinyl Tubing, Connector and S 12 Stake (No Jet)	Black	N/A/200	10.7	21DI
TA 24-7	Assembly Comprising 24" Vinyl Tubing with Connector, Valve for Flow Adjustment and S 12 Stake	Black	N/A/200	11.1	21DI



## Multioutlet Devices

### Fixed Flow Rate Devices



Cuatro-Flo™

Part No.	Description	Color	Bag Qty./ Box Qty.	Weight per 100 (lbs.)	Product Class
<b>Cuatro-Flo™</b>					
CFL 2	2 gph/Outlet Bubbler, 4 Swivel Barbed Outlets 1/2" FIPT, Pressure Compensating Cuatro-Flo™ Bubbler	Blue	25/100	5.5	21DI
CFL 10	10 gph/Outlet Bubbler, 4 Swivel Barbed Outlets 1/2" FIPT, Pressure Compensating Cuatro-Flo™ Bubbler	Red	25/100	5.5	21DI
CFL 20	20 gph/Outlet Bubbler, 4 Swivel Barbed Outlets 1/2" FIPT, Pressure Compensating Cuatro-Flo™ Bubbler	Green	25/100	5.5	21DI

### Adjustable Flow Rate Devices

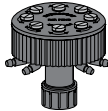

Hydroport™

Part No.	Description	Color	Bag Qty./ Box Qty.	Weight per 100 (lbs.)	Product Class
<b>Hydroport™</b>					
HPAM 4	0-20 gph, Adjustable Flow, 1/2" FIPT, 4 Port Outlet Hydroport™ Adjustable Manifold	Black	10/30	30.0	21DI
HPAM 8	0-20 gph, Adjustable Flow, 1/2" FIPT, 8 Port Outlet Hydroport™ Adjustable Manifold	Black	10/30	30.0	21DI

## Fittings & Accessories

### Smart Loc™ Multi-Diameter Fittings



Part No.	Description	Color	Bag Qty./ Box Qty.	Weight per 100 (lbs.)	Product Class
CMAP 75-18	3/4" Male Pipe Thread Adaptor (Fits 16mm, 17mm & 18mm Tubing)	Black	25/250	0.375	21DI
SLC 18	Coupling (Fits 16mm, 17mm & 18mm Tubing)	Black	25/250	0.375	21DI
CEP 18	End Plug (Fits 16mm, 17mm & 18mm Tubing)	Black	25/250	0.375	21DI
CEL 18	Elbow (Fits 16mm, 17mm & 18mm Tubing)	Black	25/250	0.375	21DI
CMAH 18	Male Hose Thread Adaptor (Fits 16mm, 17mm & 18mm Tubing)	Black	25/250	0.375	21DI
CSA 18	Swivel Adaptor Female Hose Thread (Fits 16mm, 17mm & 18mm Tubing)	Black	25/250	0.375	21DI
CMAP 5-18	1/2" Male Pipe Thread Adaptor (Fits 16mm, 17mm & 18mm Tubing)	Black	25/250	0.375	21DI
CT 18	Tee (Fits 16mm, 17mm & 18mm Tubing)	Black	25/250	0.375	21DI

### 17mm Insert Fittings



Part No.	Description	Color	Bag Qty./ Box Qty.	Weight per 100 (lbs.)	Product Class
BTMA 1750	17mm Insert x 1/2" MPT Adapter	Brown	10/bag	1.71	21DI
BTMA 1775	17mm Insert x 3/4" MPT Adapter	Brown	10/bag	2.40	21DI
BV 17	17mm Insert Ball Valve	Black	-	4.10	21DI
C 17	17mm Insert Coupling	Brown	25/bag	2.25	21DI
CX 17	17mm Insert Cross	Brown	-	-	21DI
EL 17	17mm Insert Elbow	Brown	25/bag	1.32	21DI
T 17	17mm Insert Tee	Brown	25/bag	1.73	21DI
TMA 1750	17mm Insert Tee x 1/2" MPT Adapter	Brown	-	2.35	21DI
YMA 1775	17mm Insert Y x 3/4" MPT Adapter	Brown	-	4.15	21DI

## Compression Solvent Weld Adapters

Part No.	Description	Color	Bag Qty./ Box Qty.	Weight per 100 (lbs.)	Product Class
CA 250	Compression Adapter (1/2" Slip x .250" OD Tubing) Use w/A 455 Tubing (3/8" Tubing)	Orange	100/2,000	0.6	21DI
CA 600	Compression Adapter (1/2" Slip x .610" to .640" OD Tubing) Use w/A 620 Tubing (1/2" Tubing)	Green	100/2,000	0.5	21DI
CA 700	Compression Adapter (1/2" Slip x .680" to .704" OD Tubing) Use w/A 700 Tubing (1/2" Tubing)	Black	100/2,000	0.4	21DI
CA 710	Compression Adapter (1/2" Slip x .704" to .710" OD Tubing) Use w/A 710 Tubing (1/2" Tubing)	Blue	100/2,000	0.4	21DI
CA 900	Compression Adapter (3/4" Slip x .940" OD Tubing) Use w/A 940 Tubing (3/4" Tubing)	Grey	100/1,000	0.8	21DI
SA 700	Socket Adapter - ID Bonds Over 1/2" PVC Pipe, OD Bonds into 3/4" PVC Socket Use w/A 700 Tubing (1/2" Tubing)	Black	100/600	1.5	21DI

## Compression Fittings

Part No.	Description	Color	Bag Qty./ Box Qty.	Weight per 100 (lbs.)	Product Class
CC 600	Compression Coupling (Fits .610" to .640" OD Tubing i.e. A 620)	Green	25/1,000	2.8	21DI
CC 700	Compression Coupling (Fits .680" to .704" OD Tubing i.e. A 700)	Black	25/1,000	2.8	21DI
CC 710	Compression Coupling (Fits .704" to .710" OD Tubing i.e. A 710)	Blue	25/1,000	2.7	21DI
CC 800	Compression Coupling (Fits .830" OD Tubing)	Black	25/500	6.0	21DI
CC 900	Compression Coupling (Fits .940" OD Tubing i.e. A 940)	Grey	25/500	5.7	21DI
CC 900-71	Compression Coupling (Fits .940" OD Tubing i.e. A940 and .704" to .710" OD Tubing i.e. A710 Tubing)	Black/Grey	25/500	5.7	21DI
RCC 8090	Reducing Compression Coupling (800 Series to 900 Series)	Black/Grey	25/500	5.7	21DI
RCC 7090	Reducing Compression Coupling (700 Series to 900 Series)	Black/Grey	25/500	4.0	21DI
CEL 600	Compression Elbow (.610" to .640" OD Tubing i.e. A 620)	Green	25/800	3.9	21DI
CEL 700	Compression Elbow (.680" to .704" OD Tubing i.e. A 700)	Black	25/800	3.7	21DI
CEL 710	Compression Elbow (.704" to .710" OD Tubing i.e. A 710)	Blue	25/800	3.7	21DI
CEL 900	Compression Elbow (Fits .940" OD Tubing i.e. A 940)	Grey	25/500	5.9	21DI
CT 600	Compression Tee (.610" to .640" OD Tubing i.e. A 620)	Green	15/480	5.5	21DI
CT 700	Compression Tee (.680" to .704" OD Tubing i.e. A 700)	Black	15/480	5.2	21DI
CT 710	Compression Tee (.704" to .710" OD Tubing i.e. A 710)	Blue	15/480	5.2	21DI
CT 900	Compression Tee (Fits .940" OD Tubing i.e. A 940)	Grey	25/300	8.4	21DI

### Compression End Caps

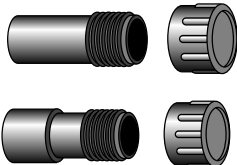

Part No.	Description	Color	Bag Qty./ Box Qty.	Weight per 100 (lbs.)	Product Class
CEP 600	End Plug with Cap (Fits .610" to .640" OD Tubing i.e. A 620)	Green	25/800	4.0	21DI
CEP 700	End Plug with Cap (Fits .680" to .704" OD Tubing i.e. A 700)	Black	25/800	4.0	21DI
CEP 710	End Plug with Cap (Fits .704" to .710" OD Tubing i.e. A 710)	Blue	25/800	4.0	21DI
CEP 900	End Plug with Cap (Fits .940" OD Tubing i.e. A 940)	Grey	25/600	5.1	21DI

Note: All caps are unscrewing caps.

### Compression Male Adapters



Part No.	Description	Color	Bag Qty./ Box Qty.	Weight per 100 (lbs.)	Product Class
CMAH	3/4" MHT x 1/2" Slip Socket Adapter	Black	50/1,000	1.8	21DI
CMAH 700	3/4" MHT Adapter (Fits .680" to .704" OD Tubing i.e. A 700)	Black	50/1,000	2.2	21DI
CMAP 700	3/4" MIPT Adapter (Fits .680" to .704" OD Tubing)	Black	50/1,000	2.2	21DI
CMAP 710	3/4" MIPT Adapter (Fits .704" to .710" OD Tubing)	Blue	50/1,000	2.1	21DI
CMAP 800	3/4" MIPT Adapter (Fits .830" OD Tubing)	Black	25/800	3.5	21DI
CMAP 900	3/4" MIPT Adapter (Fits .940" OD Tubing)	Grey	25/800	3.3	21DI
CMAP5-600	1/2" MIPT Adapter (Fits .610" to .640" OD Tubing)	Green	50/1,000	1.6	21DI
CMAP5-700	1/2" MIPT Adapter (Fits .680" to .704" OD Tubing)	Black	50/1,000	1.5	21DI
CMAP5-710	1/2" MIPT Adapter (Fits .704" to .710" OD Tubing)	Blue	50/1,000	1.5	21DI

## Compression 3/4" Swivel Fittings

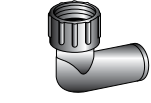
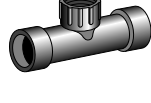
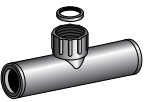
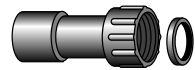
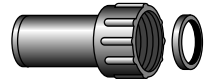
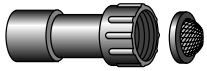
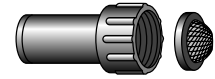

Part No.	Description	Color	Bag Qty./ Box Qty.	Weight per 100 (lbs.)	Product Class
CSA 700	3/4" FHT Swivel Adapter w/Screen (Fits .680" to .704" OD Tubing i.e. A 700)	Black	25/800	3.8	21DI
CSA 900	3/4" FHT Swivel Adapter w/Screen (Fits .940" OD Tubing i.e. A 940)	Grey	25/600	4.8	21DI
CSAW 700	3/4" FHT Swivel Adapter w/Washer (Fits .680" to .704" OD Tubing)	Black	25/800	3.5	21DI
CSAW 710	3/4" FHT Swivel Adapter w/Washer (Fits .704" to .710" OD Tubing)	Blue	25/800	3.5	21DI
CSAW 900	3/4" FHT Swivel Adapter w/Washer (Fits .940" OD Tubing)	Grey	25/600	4.7	21DI
CST 600	3/4" FHT Swivel Tee w/Screen (Fits .610" to .640" OD Tubing)	Green	15/480	6.4	21DI
CST 700	3/4" FHT Swivel Tee w/Screen (Fits .680" to .704" OD Tubing)	Black	15/480	6.2	21DI
CSTW 600	3/4" FHT Swivel Tee w/Washer (Fits .610" to .640" OD Tubing)	Green	15/480	6.0	21DI
CSTW 900	3/4" FHT Swivel Tee w/Washer (Fits .940" OD Tubing)	Grey	25/300	8.0	21DI
CSEL 700	3/4" FHT Swivel Elbow w/Screen (Fits .680" to .704" OD Tubing)	Black	25/500	4.7	21DI
CSEL 710	3/4" FHT Swivel Elbow w/Screen (Fits .704" to .710" OD Tubing)	Blue	25/500	4.7	21DI
CSELW 700	3/4" FHT Swivel Elbow w/Washer (Fits .680" to .704" OD Tubing)	Black	25/500	4.4	21DI

### Micro Fittings

Part No.	Description	Color	Bag Qty./ Box Qty.	Weight per 100 (lbs.)	Product Class
 BB 250	Connector with Flange (Barb x Barb) (Fits 0.160" ID - 0.170" ID Tubing)	Black	100/5,000	0.1	21DI
 DBC 250	Connector (Double Barb x Double Barb) (Fits 0.160" ID - 0.170" ID Tubing)	Black	100/5,000	0.1	21DI
 BT 250	Adapter - Barb x Thread (Fits 0.160" ID - 0.170" ID Tubing) Use with A 250 (1/4" tubing), see page 107	Black	100/2,000	0.1	21DI
 TT 250	Adapter - Thread x Thread (Fits 0.160" ID - 0.170" ID Tubing) Use with A 250 (1/4" tubing), see page 107	Black	100/2,000	0.1	21DI
 C 125	Connector (Barb x Barb) (Fits 0.125" ID Tubing) Use with A 185 (1/8" tubing), see page 107	Black	100/5,000	0.1	21DI
 C 250	Connector (Barb x Barb) (Fits 0.160" ID - 0.170" ID Tubing) Use with A 250 (1/4" tubing), see page 107	Black	100/10,000	0.1	21DI
 T 250	Tee (Barb x Barb x Barb) (Fits 0.160" ID - 0.170" ID Tubing) Use with A 250 (1/4" tubing), see page 107	Black	100/3,000	0.2	21DI
 EL 250	Elbow (Barb x Barb) (Fits 0.160" ID - 0.170" ID Tubing) Use with A 250 (1/4" tubing), see page 107	Black	100/3,000	0.2	21DI
 GP 2	Dual Goof Plug (20/Rack) Use with A 250 (1/4" tubing) see page 107	Black	100/10,000	0.1	21DI
 SAT	Adapter for A 220 and A 250 Tubing, see page 107 (1/2" FIPT x Barb)	Black	100/400	1.1	21DI
 REA	Adapter for 1/4" Barbed Drip Emitter (1/2" FIPT x Emitter Socket dapter)	Black	100/400	1.3	21DI
 ST 250	Adapter for Dura-Flo™ Jr (page 97) and 1/4" Tubing, see page 107 (1/2" FIPT x 1/4" Barbed Swivel Tee)	Black	100/300	1.4	21DI
 SEL 250	Adapter for Dura-Flo™ Jr (page 97) and 1/4" Tubing (see page 107) (1/2" FIPT x 1/4" Barbed Swivel Elbow)	Black	100/300	1.4	21DI
 RA 250	Riser Extension Adapter (1/2" FIPT x 1/2" MIPT x 1/4" Barb)	Black	25/100	2.6	21DI

## Compression 1/2" Riser Adapters



Part No.	Description	Color	Bag Qty./ Box Qty.	Weight per 100 (lbs.)	Product Class
RSTW 700	1/2" Riser Swivel Tee (Fits .680" to .704" OD Tubing)*	Black	40/80	6.1	21DI
RSTW 710	1/2" Riser Swivel Tee (Fits .704" to .710" OD Tubing)*	Blue	40/80	6.0	21DI
RSELW 700	1/2" Riser Swivel Elbow (Fits .680" to .704" OD Tubing)*	Black	50/100	4.8	21DI
RSELW 710	1/2" Riser Swivel Elbow (Fits .704" to .710" OD Tubing)*	Blue	50/100	4.8	21DI

\*Products include washer.

## Figure 8 End Enclosures



Part No.	Description	Color	Bag Qty./ Box Qty.	Weight per 100 (lbs.)	Product Class
F 870	Figure "8" End Plug (Fits .620" OD to .710" OD Tubing) Fits A 620, A 700, A 710 Tubing	Black	100/3,000	0.7	21DI
F 890	Figure "8" End Plug (Fits .830" OD to .940" OD Tubing) Fits A 940 Tubing	Black	100/1,500	1.5	21DI

## Sod Staples

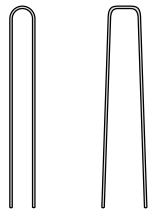

Part No.	Description	Color	Bag Qty./ Box Qty.	Weight per 100 (lbs.)	Product Class
FW6	6" Sod Staple Flat Top	N/A	N/A/1,000	3.5	21DT
FW6/100	6" Sod Staple Flat Top	N/A	100/N/A	3.5	21DT
SW6	6" Sod Staple Round Top	N/A	N/A/1,000	3.4	21DT
SW6/100	6" Sod Staple Round Top	N/A	100/N/A	3.4	21DT



### Stakes

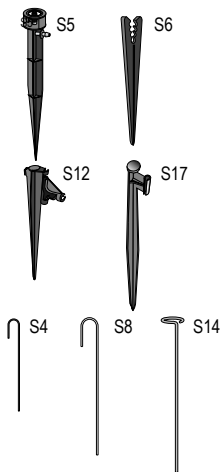

Part No.	Description	Color	Bag Qty./ Box Qty.	Weight per 100 (lbs.)	Product Class
S 5	5" Plastic Elbow Stake with 1/4" Barbed Side Inlet and 10/32 NFT Outlet	Black	100/1,500	1.4	21DI
S 6	6" Plastic Stake (Fits A 185, A 220 and A 250 Tubing, see page 107)	Black	100/3,000	1.0	21DI
S 12	12" Plastic Stake to Hold A 250/V 250 Tubing	Black	100/300	6.2	21DI
S 17	17" Plastic Stake to Support .160" ID x .300" OD Rigid Risers	Black	250/250	9.4	21DI
S 4	5" 14-Gauge Galvanized Wire Stake	Silver	100/2,500	1.2	21DI
S 8	8" 12-Gauge Galvanized Wire Stake	Silver	100/2,000	0.5	21DI
S 14	14" 11-Gauge Galvanized Wire Stabilizer Stake for Rigid Riser Jet Assemblies	Silver	50/1,000	5.0	21DI

### Valves



Part No.	Description	Color	Bag Qty./ Box Qty.	Weight per 100 (lbs.)	Product Class
BV 75	3/4" FHT x 3/4" MHT Ball Valve	Black	25/150	3.8	21di
FC 700	1/2" Flow Controlling Valve (Fits .680" to .704" OD Tubing i.e. A 700)	Black	25/200	5.4	21di
FC 710	1/2" Flow Controlling Valve (Fits .704" to .710" OD Tubing i.e. A 710)	Blue	25/200	5.4	21di

**Note: Not to be used as a shutoff valve.**

FC 900	3/4" Flow Controlling Valve (Fits .940" OD Tubing i.e. A 940)	Grey	25/125	7.5	21di
--------	---	------	--------	-----	------

## Air/Vacuum Valves



Part No.	Description	Color	Bag Qty./ Box Qty.	Weight per 100 (lbs.)	Product Class
AVRV 50	1/2" Air/Vacuum release valve (1/2" MIPT inlet)	Black	25/100	1.6	21DI

## Hole Punches

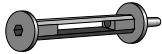

Part No.	Description	Color	Bag Qty./ Box Qty.	Weight per 100 (lbs.)	Product Class
HP 100	Hole Punch for 1/8" Fittings. Insert Tool for BT 250, TT 250 Fittings	Blue	10/150	3.8	21DI
HP 125	Hole Punch for PC Plus™, Multi-Flo™, Aqua-Flo™, Dial-a-Flo™, Super-Flo™, Misti-Flo™ and 1/4" Fittings. Insert Tool for BT 250, TT 250 Fittings.	Green	10/150	3.8	21DI

## Emitter Access Boxes



Part No.	Description	Color	Bag Qty./ Box Qty.	Weight per 100 (lbs.)	Product Class
EB 6	6" Emitter/Bubbler Access Box	Black	24/24	57.7	21DI
EBDS 6	6" Emitter/Bubbler Access Box for Desert Landscaping	Tan	24/24	57.7	21DI
EBRC 6	6" Emitter/Bubbler Access Box for Reclaimed Water	Purple	N/A/24	57.7	21DI

## Tubing Accessories and Miscellaneous

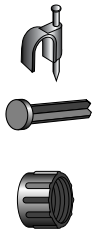

Part No.	Description	Color	Bag Qty./ Box Qty.	Weight per 100 (lbs.)	Product Class
MC 250	1/4" Mounting Clamp (Fits A 220 and A 250 Tubing)	Black	100/4,000	0.2	21DI
MC 710	1/2" Mounting Clamp (Fits A 620 and A 700 Tubing)	Black	100/1,000	0.6	21DI
BP 250	Bug Plug for A 220 and A 250	Black	100/5,000	0.1	21DI
CAP 75	3/4" FHT Cap with Washer	Black	100/1,500	1.8	21DI

## Distribution Tubing

### Distribution & Supply Tubing

50 ft. & 100 ft. Coils in Shrink Wrapped Packaging

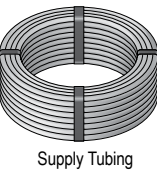
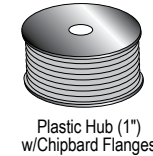
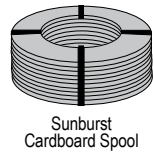
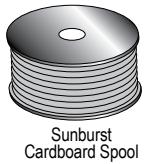
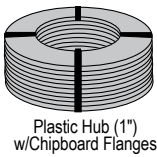

Part No.	Description	Color	Coil Size/Type	Weight per 100' (lbs.)	Product Class
A 185/100	1/8" Polyethylene Tubing (0.125" ID x 0.185" OD)	Black	100'/Coil	0.6	21DT
A 185/1000	1/8" Polyethylene Tubing (0.125" ID x 0.185" OD)	Black	1,000'/Spool	0.6	21DT
A 185V	1/8" Vinyl Tubing (0.125" ID x 0.185" OD)	Black	2,000'/Spool	1.0	21DT
A 220	1/4" Polyethylene Tubing (0.160" ID x 0.220" OD)	Black	1,500'/Spool	0.7	21DT
A 220/100	1/4" Polyethylene Tubing (0.160" ID x 0.220" OD)	Black	100'/Coil	0.7	21DT
A 220/1000	1/4" Polyethylene Tubing (0.160" ID x 0.220" OD)	Black	1,000'/Spool	0.7	21DT
A 220/2500	1/4" Polyethylene Tubing (0.160" ID x 0.220" OD)	Black	2,500'/Spool	0.7	21DT
A 220V/100	1/4" Vinyl Tubing (0.160" ID x 0.220" OD)	Black	100'/Coil	1.2	21DT
A 220V/1000	1/4" Vinyl Tubing (0.160" ID x 0.220" OD)	Black	1,000'/Spool	1.2	21DT
A 220V/2500	1/4" Vinyl Tubing (0.160" ID x 0.220" OD)	Black	2,500'/Spool	1.2	21DT
A 250	1/4" Polyethylene Tubing (0.170" ID x 0.250" OD)	Black	1,250'/Spool	1.1	21DT
A 250/50	1/4" Polyethylene Tubing (0.170" ID x 0.250" OD)	Black	50'/Coil	1.1	21DT
A 250/100	1/4" Polyethylene Tubing (0.170" ID x 0.250" OD)	Black	100'/Coil	1.1	21DT
A 250BR/100	1/4" Polyethylene Tubing (0.170" ID x 0.250" OD)	Brown	100'/Coil	1.1	21DT
A 250/500	1/4" Polyethylene Tubing (0.170" ID x 0.250" OD)	Black	500'/Spool	1.1	21DT
A 250/1000	1/4" Polyethylene Tubing (0.170" ID x 0.250" OD)	Black	1,000'/Spool	1.1	21DT
A 250/1000B	1/4" Polyethylene Tubing (0.170" ID x 0.250" OD) in Bucket	Black	1,000'/Spool in Bucket	1.1	21DT
A 250/2500	1/4" Polyethylene Tubing (0.170" ID x 0.250" OD)	Black	2,500'/Spool	1.1	21DT
A 250V/100	1/4" Vinyl Tubing (0.170" ID x 0.250" OD)	Black	100'/Coil	1.6	21DT
A 250V/1000	1/4" Vinyl Tubing (0.170" ID x 0.250" OD)	Black	1,000'/Spool	1.6	21DT
A 250V/1000B	1/4" Vinyl Tubing (0.170" ID x 0.250" OD) in Bucket	Black	1,000'/Spool in Bucket	1.6	21DT

## Distribution & Supply Tubing

All 17mm Coils in Shrink Wrapped Packaging

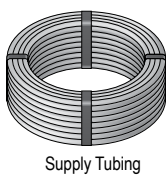
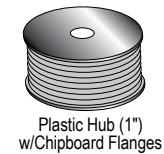
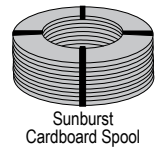
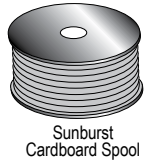
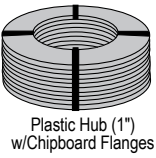

Part No.	Description	Color	Coil Size/Type	Weight per 100' (lbs.)	Product Class
A 620BR/100	1/2" Polyethylene Tubing (0.520" ID x 0.620" OD)	Brown	100'/Coil	3.6	21DT
A 620/100	1/2" Polyethylene Tubing (0.520" ID x 0.620" OD)	Black	100'/Coil	3.6	21DT
A 620/500	1/2" Polyethylene Tubing (0.520" ID x 0.620" OD)	Black	500'/Coil	3.6	21DT
A 620BR/500	1/2" Polyethylene Tubing (0.520" ID x 0.620" OD)	Brown	500'/Coil	3.6	21DT
A 660BR/100S	17mm Polyethylene Tubing (0.560" ID x 0.660" OD)	Brown	100'/ Wrapped Coil	3.8	21DT
A 660BR/250S	17mm Polyethylene Tubing (0.560" ID x 0.660" OD)	Brown	250'/ Wrapped Coil	3.8	21DT
A 660BR/500S	17mm Polyethylene Tubing (0.560" ID x 0.660" OD)	Brown	500'/ Wrapped Coil	3.8	21DT
A 700	1/2" Polyethylene Tubing (0.600" ID x 0.700" OD)	Black	500'/Coil	4.1	21DT
A 700BR	1/2" Polyethylene Tubing (0.600" ID x 0.700" OD)	Brown	500'/Coil	4.1	21DT
A 700/100	1/2" Polyethylene Tubing (0.600" ID x 0.700" OD)	Black	100'/Coil	4.1	21DT
A 700/1000	1/2" Polyethylene Tubing (0.600" ID x 0.700" OD)	Black	1,000'/Coil	4.1	21DT
A 710	1/2" Polyethylene Tubing (0.620" ID x 0.710" OD)	Black	500'/Coil	3.8	21DT
A 710GRS	1/2" Polyethylene Tubing (0.620" ID x 0.710" OD)	Black/Green Stripe	500'/Coil	3.8	21DT
A 710PS	1/2" Polyethylene Tubing (0.620" ID x 0.710" OD)	Black/Purple Stripe	500'/Coil	3.8	21DT
A 710/100RDS	1/2" Polyethylene Tubing (0.620" ID x 0.710" OD)	Black/Red Stripe	100'/Coil	3.8	21DT
A 710RDS	1/2" Polyethylene Tubing (0.620" ID x 0.710" OD)	Black/Red Stripe	500'/Coil	3.8	21DT
A 710WHS	1/2" Polyethylene Tubing (0.620" ID x 0.710" OD)	Black/White Stripe	500'/Coil	3.8	21DT
A 710YS	1/2" Polyethylene Tubing (0.620" ID x 0.710" OD)	Black/Yellow Stripe	500'/Coil	3.8	21DT
A 710/100RDS	1/2" Polyethylene Tubing (0.620" ID x 0.710" OD)	Black/Red Stripe	100'/Coil	3.8	21DT
A 940	3/4" Polyethylene Tubing (0.830" ID x 0.940" OD)	Black	500'/Coil	6.4	21DT
A 940RDS	3/4" Polyethylene Tubing (0.830" ID x 0.940" OD)	Black/Red Stripe	500'/Coil	6.4	21DT
A 940WHS	3/4" Polyethylene Tubing (0.830" ID x 0.940" OD)	Black/White Stripe	500'/Coil	6.4	21DT
A 940YS	3/4" Polyethylene Tubing (0.830" ID x 0.940" OD)	Black/Yellow Stripe	500'/Coil	6.4	21DT
A 940PS	3/4" Polyethylene Tubing (0.830" ID x 0.940" OD)	Purple Stripe	500'/Coil	N/A	21DT
A 940GRS	3/4" Polyethylene Tubing (0.830" ID x 0.940" OD)	Green Stripe	500'/Coil	6.4	21DT
A 940/100	3/4" Polyethylene Tubing (0.830" ID x 0.940" OD)	Black	100'/Coil	6.4	21DT
A 1200	1" Polyethylene Tubing (1.060" ID x 1.200" OD)	Black	500'/Coil	9.8	21DT

### IPS Flex Pipe



Part No.	Description	Color	Bag Qty./ Box Qty.	Weight per 100' (lbs.)	Product Class
IPS 50/100	1/2" IPS Flex Vinyl Pipe (0.546" ID x 0.840" OD, 0.147" Wall)	Black	100'	20.5	21DT
IPS 75/100	3/4" IPS Flex Vinyl Pipe (0.742" ID x 1.050" OD, 0.154" Wall)	Black	100'	28.5	21DT

**NOTE:** IPS Flex Pipe will work with Schedule 40 fittings.

### Swing Pipe



Part No.	Description	Color	Bag Qty./ Box Qty.	Weight per 100' (lbs.)	Product Class
SRP FLEX/20	1/2" Super Flexee™ Swing Riser Pipe (0.490" ID x 0.690" OD)	Black	20'/Coil	7.7	21DT
SRP FLEX/100	1/2" Super Flexee™ Swing Riser Pipe (0.490" ID x 0.690" OD)	Black	100'/Coil	7.7	21DT
SRP 100	1/2" Flexee™ Swing Riser Pipe (0.490" ID x 0.690" OD)	Black	100'/Coil	7.7	21DT

## Index, Professional Irrigation

Part No.	Page	Part No.	Page	Part No.	Page	Part No.	Page	Part No.	Page
A 185/100	107	A 710GRS	108	CAP POP/5	84	CSA 900	102	EBDS 6	106
A 185/1000	107	A 710PS	108	CAP POP/25	84	CSAW 700	102	EBRC 6	106
A 185V	107	A 710RDS	108	CC 600	100	CSAW 710	102	EL 17	99
A 220	107	A 710WHS	108	CC 700	100	CSAW 900	102	EL 250	103
A 220/100	107	A 710YS	108	CC 710	100	CSEL 700	102	F 870	104
A 220/1000	107	A 940	108	CC 800	100	CSEL 710	102	F 890	104
A 220/2500	107	A 940/100	108	CC 900	100	CSELW 700	102	FC 700	105
A 220V/100	107	A 940GRS	108	CC 900-71	100	CST 600	102	FC 710	105
A 220V/1000	107	A 940PS	108	CEL 18	98	CST 700	102	FC 900	105
A 220V/2500	107	A 940RDS	108	CEL 600	100	CSTW 600	102	FCO-0500	87
A 250	107	A 940WHS	108	CEL 700	100	CSTW 900	102	FPA-0500	87
A 250/50	107	A 940YS	108	CEL 710	100	CT 18	98	FPA-0750	87
A 250/100	107	A 1200	108	CEL 900	100	CT 600	100	FPC-0490	87
A 250/500	107	AFPC 5	93	CEP 18	98	CT 700	100	FPE-0500	87
A 250/1000	107	AFPC 10	93	CEP 600	101	CT 710	100	FPE-0750	87
A 250/1000B	107	AFPC 20	93	CEP 700	101	CT 900	100	FPT-0500	87
A 250/2500	107	AFPC 20/25	93	CEP 710	101	CX 17	99	FR2 17-710	84
A 250BR/100	107	AFPC 50	93	CEP 900	101	CZK 100-30F	84	FR-0500-4	87
A 250V/100	107	AVRV 50	106	CFL 2	97	CZK 100-40F	84	FR-0500-4F	87
A 250V/1000	107	BB 250	103	CFL 10	97	DAFB 180	93	FR-0500-6	87
A 250V/1000B	107	BP 250	106	CFL 20	97	DAFB 360	93	FR-0750-6	87
A 620/100	108	BT 250	103	CMAH	101	DAFB BUB	93	FW6	104
A 620/500	108	BTMA 1750	99	CMAH 18	98	DAFB FAN	93	FW6/100	104
A 620BR/100	108	BTMA 1775	99	CMAH 700	101	DAFS 180	93	GP 2	103
A 620BR/500	108	BV 17	99	CMAH 5-18	98	DAFS 360	93	HP 100	106
A 660BR/100S	108	BV 75	105	CMAH 5-18	98	DAFS BUB	93	HP 125	106
A 660BR/250S	108	C 17	99	CMAH 5-18	98	DAFS FAN	93	HPAM 4	97
A 660BR/500S	108	C 125	103	CMAH 5-18	98	DAFT 180	93	HPAM 8	97
A675CT	84	C 250	103	CMAH 75-18	98	DAFT 360	93	HYP 250	96
A 700	108	CA 250	100	CMAH 700	101	DAFT BUB	93	HYPJ 250	96
A 700/100	108	CA 600	100	CMAH 710	101	DAFT FAN	93	IPS 50/100	109
A 700/1000	108	CA 700	100	CMAH 800	101	DBC 250	103	IPS 75/100	109
A 700BR	108	CA 710	100	CMAH 900	101	DFHD-BL-10-114-05	92	MC 250	106
A 710	108	CA 900	100	CSA 18	98	DZK700/710	85	MC 710	106
A 710/100RDS	108	CAP 75	106	CSA 700	102	EB 6	106	MFA	95

## Index, Professional Irrigation

Part No.	Page	Part No.	Page	Part No.	Page	Part No.	Page	Part No.	Page
PR 20	86	S 12	105	SFJR-BL-12-01	92	SFPC-BR-17218-025S	89	TF 536	94
PR 30	86	S 14	105	SFJR-BR-06-01	92	SFPC-BR-17412-01S	89	TF 618	94
PRM 30	86	S 17	105	SFJR-BR-12-01	92	SFPC-BR-17412-05S	89	TF 636	94
PRYF 30	84	SA 700	100	SFPC-BL-6412-01	90	SFPC-BR-17412-025S	89	TFS 9	95
PRYF 40	84	SAM-0500	87	SFPC-BL-6412-05	90	SFPC-BR-17418-025S	89	TFS 16	95
R 12	96	SAT	103	SFPC-BL-6418-05	90	SLC 18	98	TMA 1750	99
RA 250	103	SEL 250	103	SFPC-BL-7212-01	91	SRP 100	109	TSA-0500-ST	86
RABB 8	96	SFCV-BR-6212-01S	88	SFPC-BL-7212-05	91	SRP FLEX/20	109	TSA-0500-TT	86
RABT 12	96	SFCV-BR-6212-05S	88	SFPC-BL-7412-01	91	SRP FLEX/100	109	TSA-0750-ST	86
RATT 12	96	SFCV-BR-6212-025S	88	SFPC-BL-7412-05	91	ST 250	103	TSA-0750-TT	86
RCC 7090	100	SFCV-BR-6218-05S	88	SFPC-BL-7418-05	91	SW6	104	TSA-1000-ST	86
RCC 8090	100	SFCV-BR-6218-025S	88	SFPC-BR-6212-05	90	SW6/100	104	TSA-1000-TT	86
REA	103	SFCV-BR-6412-01S	88	SFPC-BR-6212-025	90	T 17	99	TSA-1500-TT	86
RSELW 700	104	SFCV-BR-6412-05S	88	SFPC-BR-6412-01	90	T 250	103	TT 250	103
RSELW 710	104	SFCV-BR-6412-025S	88	SFPC-BR-6412-05	90	TA 24-4	96	VF 90	94
RSTW 700	104	SFCV-BR-6418-01S	88	SFPC-BR-6412-025	90	TA 24-7	96	VF 180	94
RSTW 710	104	SFCV-BR-6418-05S	88	SFPC-BR-6418-01	90	TAE 10	94	VF 360	94
RW16N1	95	SFCV-BR-6418-025S	88	SFPC-BR-6418-05	90	TAE 20	94	YMA 1775	99
S 4	105	SFCV-BR-6424-05S	88	SFPC-BR-6418-025	90	TAE 40	94	YS 75	85
S 5	105	SFCV-BR-7212-01	91	SFPC-BR-7212-01	91	TF 49	94	YS 100	85
S5R6	96	SFCV-BR-7412-01	91	SFPC-BR-7412-01	91	TF 59	94	YSV 75	85
S5R8	96	SFCV-BR-7412-10	91	SFPC-BR-7412-05	91	TF 69	94	YSV 100	85
S5R12	96	SFCV-BR-7412-025	91	SFPC-BR-7418-05	91	TF 418	94	YSVS 75	85
S 6	105	SFJR-BL-06-01	92	SFPC-BR-17212-05S	89	TF 436	94	YSVS 100	85
S 8	105	SFJR-BL-06-10	92	SFPC-BR-17212-025S	89	TF 518	94		

For Professional Irrigation Technical Information, Refer to Technical Specification documents at [ndspro.com/specifications](https://ndspro.com/specifications)



# Flow Management

NDS® Flow Management offers a range of engineered specialty fittings and valves. From expansion repair and compression couplings, to spring, swing check and ball valves, we offer a full line of products for irrigation, plumbing, pool and spa, and industrial applications.



## Product Applications



### Pool and Spa

Works with most PVC or CPVC pipe to transport water and prevent backflow of contaminated water in pressurized systems.



### Plumbing

Works with most DWV pipe to transport waste and prevent backflow in pressurized systems.



### Irrigation

Use for subsurface irrigation or in sprinkler control system installation; works with most PVC pipe to transport water and prevent backflow in pressurized systems.





**Check Valves**

Direct water flow one-way through pipe with check valves. Check valves are one-way valves installed in pipe systems to prevent the backflow of water and protect the pipe and other system components from damage.



**Specialty Valves**

Specialty valves include Checkmate valves which are combo valves with less bulk, a fire hydrant cap that adapts to 3/4 in. hose, and a sewer cleanout plug to remove blockages in system.



**Ball Valves**

Include a shut off point in your pipeline with a ball valve. This leak-resistant valve connects two pipes in an irrigation or other pressurized system and prevents the backflow of water.



**Flo-Lock™ Gripper Couplings and Adapters**

Connect pipe and form a leak proof joint with less chance of pull-out when properly installed.



**Pro-Span® Repair Couplings**

Fix broken PVC irrigation and plumbing pipe fast. The expandable repair coupling is engineered to stop leaks and make pipe repairs easier.



**Compression Fittings and Unions**

Choose from a variety of fittings to create leak-resistant connections, "T" intersections or to transition pipe types. Unions provide a corrosion-free connection and reduce pull-out from pipes.

## Compression Fittings

### IPS Couplings, Tees & Adapters

Specifications: PVC, Rated @ 150 PSI Static Pressure @ 72°F

Couplings  
PVC



Slip Tee  
PVC



Threaded Tee  
PVC



Part No.	Ref. No.	IPS Size UC Connection	IPS Branch	Body Length	Color	Pkg. Qty.	Case (lbs.)	Product Class	Specifications
<b>Couplings — PVC</b>									
CPC-0500	110-05	1/2"		4-1/2"	White	30	7.0	42CP	PVC NSF/ANSI 61+372 UPC
CPC-0750	110-07	3/4"		5-1/4"	White	24	8.2	42CP	
CPC-1000	110-10	1"		5-3/4"	White	18	8.2	42CP	
CPC-1250	110-12	1-1/4"		6-1/4"	White	12	7.6	42CP	
CPC-1500	110-15	1-1/2"		6-3/4"	White	15	12.25	42CP	
CPC-2000	110-20	2"		7-1/8"	White	12	14.2	42CP	
CPC-2500	110-25	2-1/2"		9-5/8"	White	5	12.25	42CP	
CPC-3000	110-30	3"		10-7/8"	White	4	13.2	42CP	
CPC-4000	110-40	4"		12-1/8"	White	3	13.9	42CP	
CPC-6000	110-60	6"		11-3/8"	White	1	8.6	42CP	
<b>Slip Tee</b>									
CPT-0500-S	121-05	1/2"	1/2" S	5"	White	24	7.0	42CP	PVC NSF/ANSI 61+372 UPC
CPT-0750-S	121-07	3/4"	3/4" S	5-3/8"	White	20	8.0	42CP	
CPT-1000-S	121-10	1"	1" S	5-5/8"	White	12	7.0	42CP	
CPT-1250-S	121-12	1-1/4"	1-1/4" S	6-1/8"	White	8	6.2	42CP	
CPT-1500-S	121-15	1-1/2"	1-1/2" S	6-3/4"	White	6	6.4	42CP	
CPT-2000-S	121-20	2"	2" S	7-1/2"	White	5	7.25	42CP	
<b>Threaded Tee</b>									
CPT-0750-T	120-07	3/4"	3/4" FPT	5-3/8"	White	20	8.0	42CP	PVC NSF/ANSI 61+372
CPT-1000-T	120-10	1"	1" FPT	5-5/8"	White	12	7.0	42CP	
CPT-1250-T	120-12	1-1/4"	1-1/4" FPT	6-1/8"	White	8	6.2	42CP	
CPT-1500-T	120-15	1-1/2"	1-1/2" FPT	6-3/4"	White	6	6.4	42CP	
CPT-2000-T	120-20	2"	2" FPT	7-1/2"	White	5	7.25	42CP	

Note: All dimensions are nominal.

## IPS Couplings, Tees & Adapters, continued

Specifications: PVC, Rated @ 150 PSI Static Pressure @ 72°F

PVC Male Adapter



Part No.	Ref. No.	IPS Size UC Connection	IPS Branch	Body Length	Color	Pkg. Qty.	Case (lbs.)	Product Class	Specifications
<b>PVC Male Adapter</b>									
CPA-0750	130-07	3/4"	3/4" MPT	4"	White	36	8.2	42CP	PVC NSF/ANSI 61+372 UPC
CPA-1000	130-10	1"	1" MPT	4"	White	24	7.0	42CP	
CPA-1250	130-12	1-1/4"	1-1/4" MPT	4-1/8"	White	18	7.3	42CP	
CPA-1500	130-15	1-1/2"	1-1/2" MPT	4-3/8"	White	16	8.2	42CP	
CPA-2000	130-20	2"	2" MPT	4-5/8"	White	12	8.8	42CP	

Note: All dimensions are nominal.

## CTS Couplings & Tees

PVC Couplings



Part No.	Ref. No.	IPS Size UC Connection	IPS Branch	Body Length	Color	Pkg. Qty.	Case (lbs.)	Product Class	Specifications
<b>PVC Couplings</b>									
CCC-0500	210-05	1/2" UC		4"	White	48	5.8	42CP	PVC NSF/ANSI 61+372 UPC
CCC-0750	210-07	3/4" UC		4"	White	30	7.0	42CP	
CCC-1000	210-10	1" UC		5-1/4"	White	24	8.2	42CP	

Note: All dimensions are nominal.

## Stub Wrenches

Stub Wrench



Part No.	Description	Pkg Qty.	Product Class	Specifications
SW-0500-C	1/2" + 3/4" Plastic Riser Extractor	25	42LS	Steel Handle

## Flo-Lock™

### Flo-Lock™ eliminates pullout.

See specifications for use on PE tubing, PVC pipe, or copper tubing.

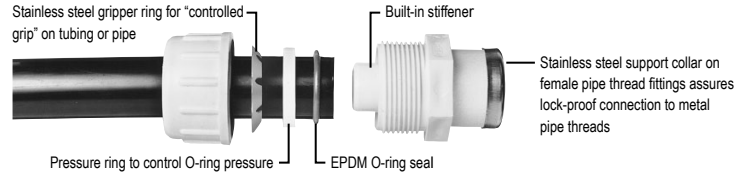

## Flo-Lock™ Tube Size SIDR-7 Pep Couplings & Adapters – Series 800

Specifications: Rated @ 200 PSI Static Pressure @ 72 °F

Coupling



Male Adapter



Female Adapter



Spigot Adapter



Part No.	Tube Size	Connection Size	Body Length	Color	Pkg. Qty.	Case (lbs.)	Product Class	Specifications
<b>Coupling</b>								
810-07	3/4"	3/4" x 3/4" TS	4-1/2"	White	24	10.6	41FL	For use on Polyethylene Tube Size SIDR-7 ASTM D-2239
810-10	1"	1" x 1" TS	5"	White	15	8.5	41FL	
<b>Male Adapter</b>								
830-07	3/4"	3/4" MPT x 3/4" TS	2-5/8"	White	20	5.0	41FL	For use on Polyethylene Tube Size SIDR-7 ASTM D-2239 PVC NSF/ANSI 61+372 UPC 830- 07/10 Only
830-10	1"	1" MPT x 1" TS	3-1/4"	White	28	9.4	41FL	
830-71	3/4" x 1"	3/4" MPT x 1" TS	3-1/2"	White	18	5.5	41FL	
830-121	1" x 1-1/4"	1" MPT x 1-1/4" TS	3"	White	12	4.3	41FL	
<b>Female Adapter</b>								
831-07	3/4"	3/4" FPT x 3/4" TS	2-5/8"	White	20	6.0	41FL	For use on Polyethylene Tube Size SIDR-7 ASTM D-2239 PVC NSF/ANSI 61+372
831-10	1"	1" FPT x 1" TS	2-7/8"	White	28	10.8	41FL	
<b>Spigot Adapter</b>								
833-07	3/4"	3/4" IPS Spg x 3/4" TS	3"	White	20	5.0	41FL	For use on Polyethylene Tube Size SIDR-7 ASTM D-2239 PVC NSF/ANSI 61+372 UPC
833-71	3/4" x 1"	3/4" IPS Spg x 1" TS	3"	White	20	7.0	41FL	
833-10	1"	1" IPS Spg x 1" TS	3"	White	28	9.4	41FL	

\*Insert stiffener supplied must be used with this fitting.

We put water in its place™

## Flo-Lock™ Tube Size SDR-9 CTS Couplings & Adapters – Series 700

Specifications: Rated @ 200 PSI Static Pressure @ 72 °F

PVC Couplings



Male Adapter



Female Adapter



Spigot Adapter



Part No.	Tube Size	Connection Size	Body Length	Color	Pkg. Qty.	Case (lbs.)	Product Class	Specifications
<b>PVC Couplings</b>								
710-07	3/4"	3/4" x 3/4" TS	4"	White	35	9.8	41FL	For use on Polyethylene Tube Size SDR-9 ASTM D-2737 PVC NSF/ANSI 61+372 UPC
710-10	1"	1" x 1" TS	4-1/2"	White	24	9.4	41FL	
710-17	3/4" x 1"	1" SDR-9 x 3/4" SDR-11	4"	White	36	11.8	41FL	
710-12	1-1/4"	1-1/4" x 1-1/4" TS	5"	White	15	8.5	41FL	
710-15*	1-1/2"	1-1/2" x 1-1/4" ts	6"	White	16	13.0	41FL	
710-20*	2"	2" x 2" ts	7-1/2"	White	12	15.9	41FL	
710-17-9	3/4" x 1"	1" SDR-9 x 3/4" SDR 9	4"	White	36	11.8	41FL	
<b>Male Adapter</b>								
730-07	3/4"	3/4" MPT x 3/4" TS	2-5/8"	White	25	4.75	41FL	For use on Polyethylene Tube Size SDR-9 ASTM D-2737 PVC UPC except 730-12-10 NSF/ANSI 61+372
730-71	3/4" x 1"	3/4" MPT x 1" TS	2-7/8"	White	18	4.6	41FL	
730-10	1"	1" MPT x 1" TS	2-7/8"	White	18	4.6	41FL	
730-12	1-1/4"	1-1/4" MPT x 1-1/4" TS	3-1/2"	White	12	4.6	41FL	
730-15	1-1/2"	1-1/2" MPT x 1-1/2" TS	3-1/2"	White	18	9.1	41FL	
730-20*	2"	2" MPT x 2" TS	4"	White	12	8.8	41FL	
<b>Female Adapter</b>								
731-07	3/4"	3/4" FPT x 3/4" TS	2-5/8"	White	25	6.0	41FL	For use on Polyethylene Tube Size SDR-9 ASTM D-2737 PVC NSF/ANSI 61+372 UPC
731-71	3/4" x 1"	3/4" FPT x 1" TS	2-7/8"	White	15	4.0	41FL	
731-10	1"	1" FPT x 1" TS	3"	White	15	4.8	41FL	
731-12	1-1/4"	1-1/4" FPT x 1-1/4" TS	3-1/2"	White	12	5.2	41FL	
731-12-10	1" x 1-1/4"	1" FPT x 1-1/4" TS	3-1/2"	White	12	5.2	41FL	
731-15	1-1/2"	1-1/2" FPT x 1-1/2" TS	3-1/2"	White	18	10.0	41FL	
731-20*	2"	2" FPT x 2" TS	3-3/4"	White	12	8.2	41FL	
<b>Spigot Adapter</b>								
733-07	3/4"	3/4" IPS Spg x 3/4" TS	2-7/8"	White	18	3.7	41FL	For use on Polyethylene Tube Size SDR-9 ASTM D-2737 PVC NSF/ANSI 61+372 UPC
733-71	3/4"	3/4" IPS Spg x 1" TS	2-7/8"	White	18	4.0	41FL	
733-10	1"	1" IPS Spg x 1" TS	3-1/2"	White	18	4.6	41FL	
733-12	1-1/4"	1-1/4" IPS Spg x 1-1/4" TS	3-1/2"	White	12	5.2	41FL	
733-15	1-1/2"	1-1/2" IPS Spg x 1-1/2" TS	3-1/2"	White	18	9.1	41FL	
733-20*	2"	2" IPS Spg x 2" TS	4"	White	12	7.6	41FL	

\*Insert stiffener supplied must be used with this fitting.

## Flo-Lock™ Couplings & Adapters – Series 100

Specifications: For use on PVC IPS Sizes (Rated @ 160 PSI Static Pressure @ 72 °F)

PVC IPS Coupling with Flo-Lock



PVC IPS Male Adapter with Flo-Lock



PVC IPS Female Adapter with Flo-Lock



Part No.	IPS Size	Connection	Body Length	Color	Pkg. Qty.	Case (lbs.)	Product Class	Specifications
<b>PVC IPS Coupling with Flo-Lock</b>								
112-05	1/2"		5"	White	28	8.0	41FL	For use on IPS sizes ASTM D-1785 NSF/ANSI 61+372
112-07	3/4"		5-1/2"	White	24	9.4	41FL	
112-10	1"		5-3/4"	White	15	8.5	41FL	
112-12	1-1/4"		6-1/2"	White	10	8.0	41FL	
112-15	1-1/2"		7"	White	16	14.6	41FL	
112-20	2"		7-1/2"	White	12	14.8	41FL	
<b>PVC IPS Male Adapter with Flo-Lock</b>								
135-05	1/2"	1/2" MPT	2-3/4"	White	25	4.8	41FL	For use on IPS sizes ASTM D-1785 NSF/ANSI 61+372
135-07	3/4"	3/4" MPT	3"	White	20	5.0	41FL	
135-10	1"	1" MPT	3-1/4"	White	30	8.5	41FL	
135-12	1-1/4"	1-1/4" MPT	3-1/2"	White	20	8.0	41FL	
135-15	1-1/2"	1-1/2" MPT	3-1/2"	White	16	7.4	41FL	
135-20	2"	2" MPT	4"	White	12	8.8	41FL	
<b>PVC IPS Female Adapter with Flo-Lock</b>								
136-05	1/2"	1/2" FPT	2-3/4"	White	25	4.8	41FL	For use on IPS sizes ASTM D-1785 NSF/ANSI 61+372
136-07	3/4"	3/4" FPT	3-1/4"	White	20	5.0	41FL	
136-10	1"	1" FPT	3-1/4"	White	14	4.5	41FL	

We put water in its place™

## Flo-Lock™ Adapters – Series 200 & 900

Specifications: For use on Copper Tubing CTS Series (Rated @ 160 PSI Static Pressure @ 72°F)

PVC CTS Male Adapter with Flo-Lock



PVC CTS Female Adapter with Flo-Lock



Part No.	CTS Size	Connection	Body Length	Color	Pkg. Qty.	Case (lbs.)	Product Class	Specifications
<b>PVC CTS Male Adapter with Flo-Lock (Rated @160 PSI Static Pressure @ 72°F)</b>								
235-05	1/2"	1/2" MPT	2-1/2"	White	50	6.0	41FL	For use on CTS pipe ASTM B88 NSF/ANSI 61+372 UPC Except 235-20
235-10	1"	1" MPT	3"	White	18	4.6	41FL	
235-15	1-1/2"	1-1/2" MPT	3-1/2"	White	20	8.5	41FL	
235-20	2"	2" MPT	4"	White	12	7.6	41FL	
<b>PVC CTS Female Adapter with Flo-Lock</b>								
935-07	3/4"	3/4" Spg	2-7/8"	White	20	4.5	41FL	For use on CTS pipe ASTM B88 NSF/ANSI 61+372
935-10	1"	1" Spg	2-7/8"	White	20	5.0	41FL	
935-125	1-1/4"	1-1/2" Socket	3-5/16"	White	20	7.0	41FL	
935-20	2"	2" Socket	4"	White	12	7.6	41FL	

## Expansion Repair Couplings

### Pro-Span™



Part No.	IPS Size	Body Length	Color	Pkg. Qty.	Case (lbs.)	Product Class	Specifications
118-05	1/2" S x SPG	7-1/2"	White	28	6.6	41XC	PVC 118-05 Thru 25: NSF/ANSI 61 UPC  Rated @200 PSI Static Pressure @72° F
118-07	3/4" S x SPG	7-3/4"	White	24	8.2	41XC	
118-10	1" S x SPG	9-1/2"	White	15	8.5	41XC	
118-12	1-1/4" S x SPG	10-3/4"	White	10	8.0	41XC	
118-15	1-1/2" S x SPG	12-3/4"	White	16	17.8	41XC	
118-20	2" S x SPG	13-1/2"	White	12	17.8	41XC	
118-25	2-1/2" S x SPG	18-3/4"	White	3	9.55	41XC	
118-30	3" S x SPG	21"	White	3	13.3	41XC	
118-40	4" S x SPG	22-3/4"	White	3	20.5	41XC	
118-60QF	6" S x S	26-1/4"	White	1	13.8	42RF	
QF-6000 IS NOW P/N 118-60QF, AND CARRIES THE SAME SPECIFICATIONS							PVC NSF/ANSI 61+372 Rated @150 PSI Static Pressure @72° F

### Foot Valves (Spring Check)

Foot Valve



Foot Valve Screens



Part No.	IPS Size	Body Length	Color	Pkg. Qty.	Case (lbs.)	Product Class	Specifications
<b>Foot Valve</b>							
1001-15FV	1-1/2"	8-1/2"	White	15	13.8	41CV	PVC Rated @ 200 PSI @ 72° F
1001-20FV	2"	10-1/2"	White	10	16.0	41CV	
<b>Foot Valve Screens</b>							
1800-10	1"	2"	Black	15	1.6	41CV	Material: Polyethylene 100 mesh
1800-12	1-1/4"	2-1/4"	Black	10	1.5	41CV	
1800-15	1-1/2"	2"	Black	16	2.0	41CV	
1800-20	2"	2-3/4"	Black	12	2.2	41CV	

NDS Foot Valves and Valve Screens are Made in China



## Spring Check Valves

### Spring Check Valves, PVC – Series 1001, 1002, 1011, 1012

Specifications: Rated @ 160 PSI Static Pressure @ 72 °F

FPT x FPT  
EPDM Gasket



Part No.	Ref. No.	Spring Tension	IPS Size Connection	Body Length	Color	Pkg. Qty.	Case (lbs.)	Product Class	Specifications	
<b>FPT x FPT EPDM Gasket</b>										
1001-05	KC-0500-T	1/2 lb.	1/2"	4-1/8"	White	20	5.0	41CV	PVC NSF/ANSI 61+372	
1001-07	KC-0750-T	1/2 lb.	3/4"	4-1/8"	White	20	6.0	41CV		
1001-10	KC-1000-T	1/2 lb.	1"	5-1/4"	White	20	8.0	41CV		
1001-12	KC-1250-T	1/2 lb.	1-1/4"	6-3/16"	White	15	13.0	41CV		
1001-15	KC-1500-T	1/2 lb.	1-1/2"	6-3/16"	White	15	13.8	41CV		
1001-20	KC-2000-T	1/2 lb.	2"	7-1/2"	White	10	15.0	41CV		
1001-30		1/2 lb.	3"	8-5/8"	White	8	27.4	41CV		
1002-07	KC2-0750-T	2 lb.	3/4"	4-1/8"	White	20	6.0	41CV		
1002-10	KC2-1000-T	2 lb.	1"	5-1/4"	White	20	8.0	41CV		
1002-12	KC2-1250-T	2 lb.	1-1/4"	6-3/16"	White	15	13.0	41CV		
1002-15	KC2-1500-T	2 lb.	1-1/2"	6-3/16"	White	15	13.8	41CV		
1002-20	KC2-2000-T	2 lb.	2"	7-1/2"	White	10	15.0	41CV		
1002-25		2 lb.	2-1/2"	8-5/8"	White	8	27.0	41CV		
1002-30		2 lb.	3"	8-5/8"	White	8	27.4	41CV		
<b>S x S EPDM Gasket</b>										
1011-05	KC-0500-S	1/2 lb.	1/2"	4-1/8"	White	20	5.0	41CV		PVC NSF/ANSI 61+372
1011-07	KC-0750-S	1/2 lb.	3/4"	4-1/8"	White	20	5.0	41CV		
1011-10	KC-1000-S	1/2 lb.	1"	5-1/4"	White	20	9.0	41CV		
1011-12	KC-1250-S	1/2 lb.	1-1/4"	6-3/16"	White	15	12.3	41CV		
1011-15	KC-1500-S	1/2 lb.	1-1/2"	6-1/2"	White	15	13.0	41CV		
1011-20	KC-2000-S	1/2 lb.	2"	7"	White	10	14.5	41CV		
1011-30		1/2 lb.	3"	8-5/8"	White	8	25.4	41CV		
1012-05	KC2-0500-S	2 lb.	1/2"	4-1/8"	White	20	5.0	41CV		
1012-07	KC2-0750-S	2 lb.	3/4"	4-1/8"	White	20	5.0	41CV		
1012-10	KC2-1000-S	2 lb.	1"	5-1/4"	White	20	9.0	41CV		
1012-12	KC2-1250-S	2 lb.	1-1/4"	6-3/16"	White	15	12.3	41CV		
1012-15	KC2-1500-S	2 lb.	1-1/2"	6-1/2"	White	15	13.0	41CV		
1012-20	KC2-2000-S	2 lb.	2"	7"	White	10	14.5	41CV		
1012-25		2 lb.	2-1/2"	8-5/8"	White	8	25.8	41CV		
1012-30		2 lb.	3"	8-5/8"	White	8	25.4	41CV		
<b>S x S Clear PVC EPDM Gasket</b>										
1011C10	KCC-1000-S	1/2 lb.	1"	5-1/4"	Clear	20	8.0	41CV	Clear PVC NSF/ANSI 61+372	
1011C20	KCC-2000-S	1/2 lb.	2"	7"	Clear	10	14.0	41CV		

S x S  
EPDM Gasket



S x S Clear  
PVC EPDM  
Gasket



## Spring Check Valves, PVC – Series 1700, 1090, 1136

Specifications: Rated @ 200 PSI Static Pressure @ 72 °F

White PVC True Union



Clear PVC True Union



Compact White PVC True Union



Compact Clear PVC True Union



Part No.	Spring Tension	IPS Size & Connection	Body Length	Color	Pkg. Qty.	Case (lbs.)	Product Class	Specifications
<b>White PVC True Union</b>								
1700-15	1/2 lb.	1-1/2" S x S	8-1/4"	White	12	15.4	41CV	NSF/ANSI 61+372
1700-20	1/2 lb.	2" S x S	9-3/4"	White	12	25.6	41CV	
1702-15	2 lb.	1-1/2" S x S	8-1/4"	White	12	15.4	41CV	
1702-20	2 lb.	2" S x S	9-3/4"	White	12	25.6	41CV	
<b>Clear PVC True Union</b>								
1700C10	1/2 lb.	1" S x S	6-3/4"	Clear	20	14.0	41CV	NSF/ANSI 61+372
1700C15	1/2 lb.	1-1/2" S x S	8-1/4"	Clear	12	15.4	41CV	Clear body with white nut and tailpiece
1700C20	1/2 lb.	2" S x S	9-3/4"	Clear	12	25.6	41CV	Clear body with white nut and tailpiece
<b>Compact White PVC True Union</b>								
1790-15	1/2 lb.	1-1/2" S x S	6-1/2"	White	15	13.8	41CV	NSF/ANSI 61+372
1790-20	1/2 lb.	2" S x S	7-3/8"	White	10	14.0	41CV	
<b>Compact Clear PVC True Union</b>								
1790C15	1/2 lb.	1-1/2" S x S	6-1/2"	Clear	15	13.8	41CV	Clear body with white nut and tailpiece
1790C20	1/2 lb.	2" S x S	7-3/8"	Clear	10	14.0	41CV	
1795C20	5 lb.	2" S x S	7-3/8"	Clear	10	14.0	41CV	

## Spa Spring Check Valves

Specifications: Rated @ 200 PSI Static Pressure @ 72 °F

Clear Spa  
Check Valve



Clear  
Compact



Part No.	Spring Tension	IPS Size & Connection	Body Length	Color	Pkg. Qty.	Case (lbs.)	Product Class	Specifications
<b>Clear Spa Check Valve</b>								
1050C10	1/4 lb.	1" S x 1-1/4" Spg	3-3/8"	Clear	20	5.0	41CV	Clear PVC 1/4 lb. for air blowers
1050C20	1/4 lb.	1-1/2" S x 2" Spg	5-1/8"	Clear	12	7.6	41CV	
1053C20	3 lb.	1-1/2" S x 2" Spg	5-1/8"	Clear	12	7.6	41CV	
1055C20	5 lb.	1-1/2" S x 2" Spg	5-1/8"	Clear	12	7.6	41CV	
<b>Clear Compact</b>								
S1050C20	1/4 lb.	1-1/2" S x 2" Spg	4"	Clear	12	6	41CV	Clear PVC 1/4 lb. for air blowers

## Adjustable Spring Check Valves – Series 1200, 1700

Specifications: Rated @ 200 PSI Static Pressure @ 72 °F

White  
PVC FPT x FPT

Factory Set at 5 lb.



White  
PVC S x S



Part No.	Spring Tension	IPS Size & Connection	Body Length	Color	Pkg. Qty.	Case (lbs.)	Product Class	Specifications
<b>White PVC FPT x FPT</b>								
1205-05	2 – 5 lb.	1/2"	4-1/8"	White	20	5.0	41CV	Adjusting nut 1-1/2 turn = 1 lb. force NSF/ANSI 61+372 Except: 1205V07
1205-07	2-1/2 – 5 lb.	3/4"	4-1/8"	White	20	5.0	41CV	
1205-10	4-1/8 – 17 lb.	1"	5-1/4"	White	20	9.0	41CV	
1205-12	4 – 50 lb.	1-1/4"	6-3/16"	White	15	12.3	41CV	
1205-15	3-1/2 – 50 lb.	1-1/2"	6-3/16"	White	15	12.3	41CV	
1205-20	1-3/4 – 14-1/2 lb.	2"	7-1/2"	White	10	15.5	41CV	
1205-07-20	20 lb.	3/4"	4-1/8"	White	20	5.0	41CV	
<b>White PVC S x S</b>								
1225-10	4-1/4 – 17 lb.	1"	5-1/4"	White	20	8.5	41CV	Adjusting nut 1-1/2 turn = 1 lb. force NSF/ANSI 61+372 Except: 1228V15
1225-15	3-1/2 – 50 lb.	1-1/2"	6-3/16"	White	15	13.5	41CV	

## Adjustable Inline Spring Check Valve

FF



FM



MF



Part No.	Ref. No.	IPS Size & Connection	Body Length	Pkg. Qty.	Case (lbs.)	Product Class	Specifications
<b>Gray PVC</b>							
CV-0500-FF	1100-05	1/2" FPT x FPT	2-3/4"	100	11.0	41CV	Preset @ approx. 5 lb. with EPDM Seal.  Adjusting nut 1-1/2 turn = 1 lb. force
CV-0500-FM		1/2" FPT x MPT	2-1/2"	100	11.0	41CV	
CV-0500-MF	1101-05	1/2" MPT x FPT	2-3/4"	100	11.0	41CV	
CV-0750-FF	1100-07	3/4" FPT x FPT	3"	60	8.2	41CV	
CV-0750-MF	1101-07	3/4" MPT x FPT	2-7/8"	60	8.2	41CV	
CV-1000-FF	1100-10	1" FPT x FPT	3"	40	9.0	41CV	
CV-1000-MF		1" MPT x FPT	3"	40	7.0	41CV	

## Breakaway Coupling Valves

Flo-Check  
Breakaway  
Coupling —  
Cal Trans  
Orange



Part No.	IPS Size & Connection	Body Length	Color	Pkg. Qty.	Case (lbs.)	Product Class	Specifications
<b>Flo-Check Breakaway Coupling – Cal Trans Orange</b>							
1010-05-O	1/2" FPT x 1/2" FPT	2-1/4"	Orange	30	2.5	41CV	Rated @ 150 PSI Static Pressure @ 72°F
1010-07-O	3/4" FPT x 3/4" FPT	2-3/8"	Orange	25	3.5	41CV	

Note: To be used on galvanized or iron pipe only.

## Swing Check Valves

### Swing Check Valves – Series 1500

Specifications: Rated @ 125 PSI Static Pressure @ 72 °F

White PVC  
Compression

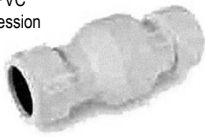

Clear PVC  
Compression



White PVC  
Threaded



White PVC  
S x S



Part No.	Ref. No.	IPS Size & Connection	Body Length	Color	Pkg. Qty.	Case (lbs.)	Product Class	Specifications
<b>White PVC Compression</b>								
1500-12	KSC-1250-C	1-1/4" UC x UC	8-1/2"	White	12	13.6	41CV	NSF/ANSI 61+372
1500-15	KSC-1500-C	1-1/2" UC x UC	8-1/2"	White	12	14.2	41CV	
1500-20	KSC-2000-C	2" UC x UC	9-1/2"	White	12	20.8	41CV	
1500-30	KSC-3000-C	3" UC x UC	13-3/8"	White	2	10.1	41CV	
<b>Clear PVC Compression</b>								
1500C15	KSCc-1500-C	1-1/2" UC x UC	8-1/2"	Clear	12	14.2	41CV	Clear PVC with white CAPS NFS/ANSI 61+372
1500C20	KSCc-2000-C	2" UC x UC	9-31/2"	Clear	12	20.8	41CV	
<b>White PVC Threaded</b>								
1520-05F	KSC-0500-T	1/2" FPT x FPT	3-1/2"	White	20	4.0	41CV	PVC NSF/ANSI 61+372
1520-07F	KSC-0750-T	3/4" FPT x FPT	3-1/2"	White	25	6.0	41CV	
1520-10F	KSC-1000-T	1" FPT x FPT	5-1/8"	White	25	9.8	41CV	
1520-12F	KSC-1250-T	1-1/4" FPT x FPT	5-1/4"	White	12	7.6	41CV	
1520-15F	KSC-1500-T	1-1/2" FPT x FPT	5-3/4"	White	12	8.2	41CV	
1520-20F	KSC-2000-T	2" FPT x FPT	6"	White	12	12.4	41CV	
<b>White PVC S x S</b>								
1520-05	KSC-0500-s	1/2" S x S	3-1/2"	White	20	4.0	41CV	PVC NSF/ANSI 61+372 Except: 1520V20
1520-07	KSC-0750-s	3/4" S x S	3-1/2"	White	25	6.0	41CV	
1520-10	KSC-1000-s	1" S x S	5-1/8"	White	25	9.8	41CV	
1520-12	KSC-1250-s	1-1/4" S x S	5-1/4"	White	12	7.6	41CV	
1520-15	KSC-1500-s	1-1/2" S x S	5-3/4"	White	12	8.2	41CV	
1520-20	KSC-2000-s	2" S x S	6"	White	12	12.4	41CV	
1520-30		3" S x S	9"	White	4	11.0	41CV	
1520-40		4" S x S	9-1/2"	White	1	4.3	41CV	
1520V20		2" S x S w/ VITON Seal	6"	White	12	12.4	41CV	

## Swing Check Valves – Series 1500

Specifications: Rated @ 125 PSI Static Pressure @ 72°F

Clear PVC  
Threaded



Clear PVC  
S x S



Part No.	Ref. No.	IPS Size & Connection	Body Length	Color	Pkg. Qty.	Case (lbs.)	Product Class	Specifications
<b>Clear PVC Threaded</b>								
1520C05F	KSCC-0500-t	1/2" FPT x FPT	3-1/2"	Clear	20	4.0	41CV	Clear PVC NSF/ANSI 61+372
1520C07F	KSCC-0750-t	3/4" FPT x FPT	3-1/2"	Clear	25	6.0	41CV	
1520C10F	KSCC-1000-t	1" FPT x FPT	5-1/8"	Clear	25	9.8	41CV	
1520C15F	KSCC-1500-t	1-1/2" FPT x FPT	5-3/4"	Clear	12	7.6	41CV	
1520C20F	KSCC-2000-t	2" FPT x FPT	6"	Clear	12	8.2	41CV	
<b>Clear PVC S x S</b>								
1520C05	KSCC-0500-S	1/2" S x S	3-1/2"	Clear	20	4.0	41CV	Clear PVC NSF/ANSI 61+372 Except 1520C15V, 1520C20V
1520C07	KSCC-0750-S	3/4" S x S	3-1/2"	Clear	25	6.0	41CV	
1520C10	KSCC-1000-S	1" S x S	5-1/8"	Clear	25	9.8	41CV	
1520C12	KSCC-1250-S	1-1/4" S x S	5-1/4"	Clear	12	7.6	41CV	
1520C15	KSCC-1500-S	1-1/2" S x S	5-3/4"	Clear	12	8.2	41CV	
1520C20	KSCC-2000-S	2" S x S	6"	Clear	12	12.4	41CV	
1520C30		3" S x S	9"	Clear	4	11.0	41CV	
1520C40		4" S x S	9-1/2"	Clear	1	4.3	41CV	

## Swing Check Valves – Series 1700 & Low-Profile

Specifications: Rated @ 125 PSI Static Pressure @ 72°F

White PVC True Union



Clear PVC True Union



PVC Low-Profile Swing Check Valve



Part No.	Ref. No.	IPS Size & Connection	Body Length	Color	Pkg. Qty.	Case (lbs.)	Product Class	Specifications
<b>White PVC True Union</b>								
1720-10		1" U x U	6-7/8"	White	20	15.0	41CV	PVC NSF/ANSI 61+372
1720-15	KSC-1500-SU	1-1/2" U x U	8"	White	12	14.2	41CV	
1720-20	KSC-2000-SU	2" U x U	9-5/8"	White	12	22.6	41CV	
<b>Clear PVC True Union</b>								
1720C07	KSCC-0750-SU	3/4" U x U	5-1/2"	Clear	20	10.0	41CV	PVC Clear body with white nuts and tailpieces NSF/ANSI 61+372
1720C10	KSCC-1000-SU	1" U x U	6-7/8"	Clear	20	15.0	41CV	
1720C15	KSCC-1500-SU	1-1/2" U x U	8"	Clear	12	14.2	41CV	
1720C20	KSCC-2000-SU	2" U x U	9-5/8"	Clear	12	22.6	41CV	
1720C30	KSCC-3000-SU	3" U x U	13-1/4"	Clear	6	24.7	41CV	
<b>PVC Low-Profile Swing Check Valve</b>								
KSL-0750-S		3/4 "	5"	White	18	8.2	41CV	PVC NSF/ANSI 61+372
KSL-1000-S		1"	4-3/4"	White	18	7.3	41CV	
KSL-1500-S		1-1/2"	5-1/2"	White	12	8.8	41CV	
KSL-2000-S		2"	6-1/2"	White	8	8.2	41CV	

## Sump Pump Valves

Specifications: Rated @ 125 PSI Static Pressure @ 72°F

Sump Pump Valve



Part No.	Ref No.	IPS Size & Connection	Body Length	Check Valve Color	Pkg. Qty.	Case (lbs.)	Product Class	Specifications
<b>Sump Pump Valve</b>								
1400-15		1-1/4" or 1-1/2" UC	5-1/4"	White	12	7.6	41CV	Buna "N" Gaskets are included in both 1-1/4" and 1-1/2" size applications

## Checkmate

Specifications: Rated @ 125 PSI Static Pressure @ 72°F

U x S



U x U



UC x UC

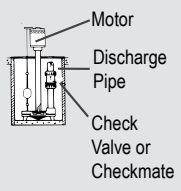

Part No.	Ref No.	IPS Size & Connection	Body Length	Check Valve Color	Pkg. Qty.	Case (lbs.)	Product Class	Specifications
<b>Checkmate</b>								
2200-15	BCX-1500-S	1-1/2" U x S	8"	White	12	19.6	41BV	
2200-15UC		1-1/2" UC x UC	10-3/4"	White	12	24.4	41BV	
2200-15TU		1-1/2" U x U	10-1/2"	White	12	25.6	41BV	
2200-20	BCX-2000-S	2" U x S	9-3/8"	White	12	28.0	41BV	
2200-20UC		2" UC x UC	12-5/16"	White	12	35.8	41BV	
2200-20TU		2" U x U	12-3/8"	White	12	37.0	41BV	



## MIP (Molded-In-Place) Ball Valves

### MIP Non-Serviceable Ball Valves, White

Specifications: Rated @ 160 PSI Static Pressure @ 72°F



Part No.	IPS Size & Connection	Body Length	Color	Pkg. Qty.	Case (lbs.)	Product Class
<b>MIP Non-Serviceable WHITE</b>						
E1310-05	1/2" S x S	3-1/4"	White	36	6.4	41MV
E1310-07	3/4" S x S	3-3/4"	White	18	5.5	41MV
E1310-10	1" S x S	4-1/4"	White	25	11.0	41MV
E1310-12	1-1/4" S x S	4-1/2"	White	12	9.4	41MV
E1310-15	1-1/2" S x S	5-1/4"	White	12	10.0	41MV
E1310-20	2" S x S	5-3/4"	White	6	7.9	41MV
E1310-25	2-1/2" S x S	7"	White	6	19.3	41MV
E1310-30	3" S x S	8-1/2"	White	2	8.8	41MV
E1310-40	4" S x S	11-1/2"	White	1	10.0	41MV
E1310-60	6" S x S	16"	White	1	22.3	41MV
E1320-05	1/2" FPT x FPT	3-1/4"	White	36	6.4	41MV
E1320-07	3/4" FPT x FPT	3-1/4"	White	18	5.5	41MV
E1320-10	1" FPT x FPT	4-1/4"	White	25	11.0	41MV
E1320-12	1-1/4" FPT x FPT	4-1/4"	White	12	9.4	41MV
E1320-15	1-1/2" FPT x FPT	5-1/2"	White	12	10.0	41MV
E1320-20	2" FPT x FPT	5-3/4"	White	6	7.9	41MV
E1320-25	2-1/2" FPT x FPT	7"	White	6	19.3	41MV
E1320-30	3" FPT x FPT	8-1/2"	White	2	8.8	41MV
E1320-40	4" FPT x FPT	11-1/2"	White	1	10.0	41MV

## MIP Non-Serviceable (NSF) Ball Valves, White

Specifications: Rated @ 160 PSI Static Pressure @ 72°F

Part No.	IPS Size	Body Length	Color	Pkg. Qty.	Case (lbs.)	Product Class
<b>MIP Non-Serviceable (NSF) WHITE</b>						
E1410-05	1/2" NSF S x S	3-1/4"	White	36	6.5	41MV
E1410-07	3/4" NSF S x S	3-3/4"	White	18	5.9	41MV
E1410-10	1" NSF S x S	4-1/4"	White	25	12.4	41MV
E1410-12	1-1/4" NSF S x S	4-1/2"	White	12	7.6	41MV
E1410-15	1-1/2" NSF S x S	5-1/4"	White	12	11.6	41MV
E1410-20	2" NSF S x S	5-3/4"	White	6	9.6	41MV
E1410-25	2-1/2" NSF S x S	7"	White	6	15	41MV
E1410-30	3" NSF S x S	8-1/2"	White	2	12.8	41MV
E1410-40	4" NSF S x S	9"	White	1	9.9	41MV
E1420-05	1/2" NSF FPT x FPT	3-1/4"	White	36	6.7	41MV
E1420-07	3/4" NSF FPT x FPT	3-1/4"	White	18	6.1	41MV
E1420-10	1" NSF FPT x FPT	4-1/4"	White	25	13	41MV
E1420-12	1-1/4" NSF FPT x FPT	4-1/4"	White	12	8	41MV
E1420-15	1-1/2" NSF FPT x FPT	5-1/2"	White	12	12	41MV
E1420-20	2" NSF FPT x FPT	5-3/4"	White	6	10	41MV
E1420-25	2-1/2" NSF FPT x FPT	7"	White	6	15.5	41MV
E1420-30	3" NSF FPT x FPT	8-1/2"	White	2	13.5	41MV
E1420-40	4" NSF FPT x FPT	9"	White	1	10.8	41MV

MIP  
Non-Serviceable (NSF)  
WHITE  
1/2" - 2"



MIP  
Non-Serviceable (NSF)  
WHITE  
2-1/2" - 4"



### MIP Non-Serviceable Ball Valves, Gray

Specifications: Rated @ 160 PSI Static Pressure @ 72°F

MIP  
Non-Serviceable  
GRAY



Part No.	IPS Size & Connection	Body Length	Color	Pkg. Qty.	Case (lbs.)	Product Class
<b>MIP Non-Serviceable GRAY</b>						
E1610-05	1/2" S x S	3-1/4"	Gray	36	6.4	41MV
E1610-07	3/4" S x S	3-3/4"	Gray	18	5.5	41MV
E1610-10	1" S x S	4-1/4"	Gray	25	11.0	41MV
E1610-12	1-1/4" S x S	4-1/2"	Gray	12	9.4	41MV
E1610-15	1-1/2" S x S	5-1/4"	Gray	12	10.0	41MV
E1610-20	2" S x S	5-3/4"	Gray	6	7.9	41MV
E1610-60	6" S x S	16"	Gray	1	22.3	41MV
E1620-05	1/2" FPT x FPT	3-1/4"	Gray	36	6.4	41MV
E1620-07	3/4" FPT x FPT	3-1/4"	Gray	18	5.5	41MV
E1620-10	1" FPT x FPT	4-1/4"	Gray	25	11.0	41MV
E1620-12	1-1/4" FPT x FPT	4-1/4"	Gray	12	9.4	41MV
E1620-15	1-1/2" FPT x FPT	5-1/2"	Gray	12	10.0	41MV
E1620-20	2" FPT x FPT	5-3/4"	Gray	6	7.9	41MV

## True Union Ball Valves

PVC Sch. 80 True Union Serviceable



PVC Sch. 80 True Union Handles



Part No.	IPS Size	Body Length	Pkg. Qty.	Case (lbs.)	Product Class	Specifications
<b>PVC Sch. 80 True Union Serviceable</b>						
BTU-0750-E	3/4" EPDM Slip & Threaded	4-3/4"	10	7.5	42BV	Connection in both slip & threaded included  Rated @ 150 PSI Static Pressure @ 72° F
BTU-1000-E	1" EPDM Slip & Threaded	5-1/4"	8	8.6	42BV	
BTU-1250-E	1-1/4" EPDM Slip & Threaded	6"	4	7.6	42BV	
BTU-1500-E	1-1/2" EPDM Slip & Threaded	6-1/4"	4	7.8	42BV	
BTU-2000-E	2" EPDM Slip & Threaded	7"	2	6.0	42BV	
BTU-2500-SE	2-1/2" SLIP EPDM	11"	1	11.0	42BV	
BTU-2500-TE	2-1/2" FPT EPDM	11"	1	11.0	42BV	
BTU-3000-SE	3" SLIP EPDM	11"	1	11.4	42BV	
<b>PVC Sch. 80 True Union Handles</b>						
BTU-0500-HL	1/2" Red Blocked True Union Handle	n/a	n/a	n/a	96MC	
BTU-0750-HL	3/4" Red Blocked True Union Handle	n/a	n/a	n/a	96MC	
BTU-1000-HL	1" Red Blocked True Union Handle	n/a	n/a	n/a	96MC	
BTU-1250-HL	1-1/4" Red Blocked True Union Handle	n/a	n/a	n/a	96MC	
BTU-1500-HL	1-1/2" Red Blocked True Union Handle	n/a	n/a	n/a	96MC	
BTU-2000-HL	2" Red Blocked True Union Handle	n/a	n/a	n/a	96MC	

## CPVC CTS Ball Valves, Tan

CPVC CTS Ball Valve TAN



Part No.	IPS Size	Body Length	Pkg. Qty.	Case (lbs.)	Product Class	Specifications
<b>CPVC CTS Ball Valve TAN</b>						
C1310-05	1/2" CTS S x S	3-1/4"	25	6.0	41MV	
C1310-07	3/4" CTS S x S	4"	25	7.0	41MV	
C1310-10	1" CTS S x S	4-1/4"	25	11.0	41MV	
C1310-12	1-1/4" CTS S x S	4-1/2"	25	14.0	41MV	
C1310-15	1-1/2" CTS S x S	5-1/2"	25	14.0	41MV	
C1310-20	2" CTS S x S	6"	15	18.0	41MV	

## PVC Unions Sch. 80

Sch. 80 Union  
SLIP x SLIP



Sch. 80 Union  
FPT x FPT



Sch. 80 Union  
SLIP x MPT



Sch. 80 Union  
SLIP x FIPT



Sch. 80 Union  
FPT x MPT



Part No.	IPS Size & Connection	Body Length	Color	Pkg. Qty.	Case (lbs.)	Product Class	Specifications	
<b>Sch. 80 Union SLIP x SLIP</b>								
U-0500-S	1/2" PVC Sch. 80 Union Slip	2"	Gray	48	5.8	42UN	PVC Rated @ 150 PSI @ 72°F NSF/ANSI 61+372 UPC (1/2-2" SLIP Only)	
U-0750-S	3/4" PVC Sch. 80 Union Slip	2-1/2"	Gray	24	5.8	42UN		
U-1000-S	1" PVC Sch. 80 Union Slip	2-3/4"	Gray	18	5.5	42UN		
U-1250-S	1-1/4" PVC Sch. 80 Union Slip	3-1/4"	Gray	12	5.8	42UN		
U-1500-S	1-1/2" PVC Sch. 80 Union Slip	3-3/4"	Gray	12	8.2	42UN		
U-2000-S	2" PVC Sch. 80 Union Slip	4"	Gray	6	6.1	42UN		
U-2500-S	2-1/2" Gray PVC Union Slip	5"	Gray	4	6.8	42UN		
U-3000-S	3" Gray PVC Union Slip	6"	Gray	2	5.0	42UN		
U-4000-S	4" Gray PVC Union Slip	7-1/4"	Gray	2	7.6	42UN		
<b>Sch. 80 Union FPT x FPT</b>								
U-0500-T	1/2" PVC Sch. 80 Union/Threaded	2"	Gray	48	5.8	42UN		
U-0750-T	3/4" PVC Sch. 80 Union/Threaded	2-1/2"	Gray	24	5.8	42UN		
U-1000-T	1" PVC Sch. 80 Union/Threaded	2-3/4"	Gray	18	5.5	42UN		
U-1250-T	1-1/4" PVC Sch. 80 Union/Threaded	3-1/4"	Gray	12	5.8	42UN		
U-1500-T	1-1/2" PVC Sch. 80 Union/Threaded	3-3/4"	Gray	12	8.2	42UN		
U-2000-T	2" PVC Sch. 80 Union/Threaded	4"	Gray	6	6.1	42UN		
U-2500-T	2-1/2" Gray PVC Threaded Union	5"	Gray	4	6.8	42UN		
U-3000-T	3" Gray PVC Threaded Union	6"	Gray	2	5.0	42UN		
U-4000-T	4" Gray PVC Threaded Union	7-1/4"	Gray	2	7.6	42UN		
<b>Sch. 80 Union SLIP x MPT</b>								
U-0500-SM	1/2" Sch. 80 Union SLIP x MIPT	3"	Gray	48	8.2	42UN		
U-0750-SM	3/4" Sch. 80 Union SLIP x MIPT	3-1/2"	Gray	24	8.2	42UN		
U-1000-SM	1" Sch. 80 Union SLIP x MIPT	4"	Gray	18	8.2	42UN		
U-1500-SM	1-1/2" Sch. 80 Union SLIP x MIPT	6-3/4"	Gray	8	6.6	42UN		
U-2000-SM	2" Sch. 80 Union SLIP x MIPT	5"	Gray	6	7.6	42UN		
<b>Sch. 80 Union SLIP x FIPT</b>								
U-1500-ST	1-1/2" Sch. 80 Union SLIP x FIPT	3-3/4"	Gray	8	4.8	42UN		
U-2000-ST	2" Sch. 80 Union SLIP x FIPT	4"	Gray	6	5.1	42UN		
<b>Sch. 80 Union FPT x MPT</b>								
U-1000-TM	1" Sch. 80 Union FIPT x MIPT	4"	Gray	18	8.2	42UN		

## PVC Unions Sch. 40

 Sch. 40 Union  
SLIP x SLIP

Part No.	IPS Size & Connection	Body Length	Color	Pkg. Qty.	Case (lbs.)	Product Class	Specifications
<b>Sch. 40 Union SLIP x SLIP</b>							
WU-0750-S	3/4" PVC SCH. 40 Union SLIP	2-1/2"	White	24	5.8	42UN	PVC Rated @ 150 PSI @ 72°F NSF/ANSI 61+372 UPC (SLIP Only)
WU-1000-S	1" PVC SCH. 40 Union SLIP	2-3/4"	White	18	5.5	42UN	
WU-1250-S	1-1/4" PVC SCH. 40 Union SLIP	3-1/4"	White	12	5.8	42UN	
WU-1500-S	1-1/2" PVC SCH. 40 Union SLIP	3-3/4"	White	12	8.2	42UN	
WU-2000-S	2" PVC SCH. 40 Union SLIP	4"	White	6	6.1	42UN	
WU-3000-S	3" PVC SCH. 40 Union SLIP	6"	White	2	5.0	42UN	
WU-4000-S	4" PVC SCH. 40 Union SLIP	7-1/4"	White	2	6.1	42UN	
<b>Sch. 40 Union FPT x FPT</b>							
WU-0750-T	3/4" PVC SCH. 40 Union FPT	2-1/2"	White	24	5.8	42UN	
WU-1250-T	1-1/4" PVC SCH. 40 Union FPT	3-1/4"	White	12	5.8	42UN	
WU-1500-T	1-1/2" PVC SCH. 40 Union FPT	3-3/4"	White	12	8.2	42UN	
WU-2000-T	2" PVC SCH. 40 Union FPT	4"	White	6	6.1	42UN	

 Sch. 40 Union  
FPT x FPT

## Fire Hydrant Cap & Sewer Cleanout

Cap



Cleanout



Part No.	IPS Size	Body Length	Color	Pkg. Qty.	Case (lbs.)	Product Class
<b>Cap</b>						
23-25T	2-1/2" FPT x 3/4" FPT	4-3/4"	Gray	15	7.0	41BV
<b>Cleanout</b>						
22-040	4" Sewer Cleanout	9-1/4"	Black	6	9.1	41BV

Saddles

Flo-Tap™ Hot/Wet Taps for PVC Pipe

Specifications: Rated @ 200 PSI Static Pressure @ 72 °F

For PVC Pipes  
3/4" and 1"  
Service Lines



For PVC Pipes  
1-1/2" and 2"  
Service Lines



Part No.	Pipe Size	Branch Size & Connection	Color	Pkg. Qty.	Case (lbs.)	Product Class	Specifications
<b>For PVC Pipes 3/4" and 1" Service Lines</b>							
3115	1-1/2"	3/4" S x 1" SPG	Gray	5	5.5	41FS	For PVC Pipe Pressure Rated @ 200 PSI @ 72°F  NSF/ANSI 61+372 PVC Type II
3120	2"	3/4" S x 1" SPG	Gray	5	6.0	41FS	
3125	2-1/2"	3/4" S x 1" SPG	Gray	5	6.0	41FS	
3130	3"	3/4" S x 1" SPG	Gray	5	11.0	41FS	
3140	4"	3/4" S x 1" SPG	Gray	5	11.0	41FS	
3160	6"	3/4" S x 1" SPG	Gray	5	13.0	41FS	
<b>For PVC Pipes 1-1/2" and 2" Service Lines</b>							
3220	2"	1-1/2" S x 2" SPG	Gray	5	9.5	41FS	
3225	2-1/2"	1-1/2" S x 2" SPG	Gray	5	9.5	41FS	
3230	3"	1-1/2" S x 2" SPG	Gray	5	15.0	41FS	
3240	4"	1-1/2" S x 2" SPG	Gray	5	14.0	41FS	
3260	6"	1-1/2" S x 2" SPG	Gray	5	20.0	41FS	

## Rigid Clamp-It™ Saddles

For Poly Pipe IPS  
Pipe Sizes –  
PVC-IPS Fixed  
Outlet



For PVC IPS  
Pipe Sizes –  
PVC-IPS Fixed  
Outlet



Part No.	IPS Pipe Size	IPS Tap Size & Connection	Color	Pkg. Qty.	Case (lbs.)	Product Class	Specifications
<b>For Poly Pipe IPS Pipe Sizes – PVC-IPS Fixed Outlet</b>							
321507P	1-1/2"	3/4" FPT	Gray	25	9.0	41FS	For polyethylene tubing main line  Pressure Rated @ 125 PSI @ 72°F  NSF/ANSI 61+372 PVC Type II
321510P	1-1/2"	1" FPT	Gray	25	9.0	41FS	
331510P	1-1/2"	1" S	Gray	25	9.0	41FS	
322010P	2"	1" FPT	Gray	25	9.0	41FS	
332007P	2"	3/4" S	Gray	25	9.0	41FS	
332010P	2"	1" S	Gray	25	9.0	41FS	
344007P	4"	3/4" FPT	Gray	15	8.0	41FS	
<b>For PVC IPS Pipe Sizes – PVC-IPS Fixed Outlet</b>							
421507	1-1/2"	3/4" FPT	Gray	5	4.0	41FS	For PVC pipe main line  Pressure Rated @ 200 PSI @ 72°F  NSF/ANSI 61+372 PVC Ty
421510	1-1/2"	1" FPT	Gray	5	4.5	41FS	
422007	2"	3/4" FPT	Gray	5	4.5	41FS	
422010	2"	1" FPT	Gray	5	4.5	41FS	
422012	2"	1-1/4" FPT	Gray	5	5.0	41FS	
422015	2"	1-1/2" FPT	Gray	5	5.0	41FS	
432007	2"	3/4" S	Gray	5	4.5	41FS	
432010	2"	1" S	Gray	5	4.5	41FS	
432012	2"	1-1/4" S	Gray	5	4.5	41FS	
432015	2"	1-1/2" S	Gray	5	5.0	41FS	
422507	2-1/2"	3/4" FPT	Gray	5	5.0	41FS	
422515	2-1/2"	1-1/2" FPT	Gray	5	5.0	41FS	
422520	2-1/2"	2" FPT	Gray	5	5.0	41FS	
432510	2-1/2"	1" S	Gray	5	5.0	41FS	
432515	2-1/2"	1-1/2" S	Gray	5	5.0	41FS	
432520	2-1/2"	2" S	Gray	5	5.0	41FS	



### Rigid Clamp-It™ Saddles

For PVC IPS  
Pipe Sizes –  
PVC-IPS Fixed  
Outlet



Part No.	IPS Pipe Size	IPS Tap Size & Connection	Color	Pkg. Qty.	Caae (lbs.)	Product Class	Specifications
<b>For PVC IPS Pipe Sizes – PVC-IPS Fixed Outlet</b>							
443007	3"	3/4" fpt	Gray	5	8.0	41FS	For PVC pipe main line  Pressure Rated @ 200 PSI @ 72°F  NSF/ANSI 61+372 PVC Ty
443010	3"	1" fpt	Gray	5	8.0	41FS	
443012	3"	1-1/4" fpt	Gray	5	8.5	41FS	
443015	3"	1-1/2" fpt	Gray	5	8.5	41FS	
443020	3"	2" fpt	Gray	5	8.5	41FS	
453007	3"	3/4" s	Gray	5	8.0	41FS	
453010	3"	1" s	Gray	5	8.0	41FS	
453012	3"	1-1/4" s	Gray	5	8.0	41FS	
453015	3"	1-1/2" s	Gray	5	8.5	41FS	
453020	3"	2" s	Gray	5	8.5	41FS	
444007	4"	3/4" fpt	Gray	5	9.5	41FS	
444010	4"	1" fpt	Gray	5	9.5	41FS	
444012	4"	1-1/4" fpt	Gray	5	10.0	41FS	
444015	4"	1-1/2" fpt	Gray	5	10.0	41FS	
444020	4"	2" fpt	Gray	5	10.0	41FS	
454010	4"	1" s	Gray	5	9.5	41FS	
454015	4"	1-1/2" s	Gray	5	9.5	41FS	
454020	4"	2" s	Gray	5	9.5	41FS	
446007	6"	3/4" fpt	Gray	5	12.0	41FS	
446010	6"	1" fpt	Gray	5	12.0	41FS	
446015	6"	1-1/2" fpt	Gray	5	12.5	41FS	
446020	6"	2" fpt	Gray	5	12.5	41FS	
456010	6"	1" s	Gray	5	11.5	41FS	
456015	6"	1-1/2" s	Gray	5	12.0	41FS	
456020	6"	2" s	Gray	5	12.0	41FS	
448010	8"	1" fpt	Gray	5	17.0	41FS	
448015	8"	1-1/2" fpt	Gray	5	17.0	41FS	
448020	8"	2" fpt	Gray	5	17.0	41FS	
458015	8"	1-1/2" s	Gray	5	17.0	41FS	
458020	8"	2" s	Gray	5	17.0	41FS	

## Swing Joints

Specifications: PVC, Rated @315 PSI @ 72°F



PVC Sch. 80  
Swing Assembly  
Gray

Part No.	Description	Color (Box/Cover)	Pallet Qty.	Product Class
<b>PVC Sch. 80 Swing Assembly</b>				
TSA-0500-TT	1/2" M x M	Gray	60	42TS
TSA-0750-ST	3/4" S x M	Gray	50	42TS
TSA-0750-TT	3/4" M x M	Gray	50	42TS
TSA-1000-ST	1" S x M	Gray	25	42TS
TSA-1000-TT	1" M x M	Gray	25	42TS
TSA-1500-TT	1-1/2" M x M	Gray	15	42TS

## Backwater Valves



[See list of Backwater Valve products on page 153 & page 154](#)

### Landscape Sprinkler Products



Cutoff Risers



Flex Risers



Cutoff Riser Extension



Swing Pipe Fittings

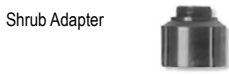

Shrub Adapter

Part No.	Description	Carton. Qty.	Product Class	Specifications
<b>Cut-Off Risers</b>				
FCO-0500	1/2" x 6" Flex Cut-Off	50	42LS	Rated @ 70 PSI @ 72°F
<b>Flex Risers</b>				
FR-0500-4	1/2" x 4" MIPT x MIPT Flex Riser	100	42LS	Rated @ 70 PSI @ 72°F
FR-0500-4F	1/2" x 4" MPT x FPT Flex Riser	100	42LS	
FR-0500-6	1/2" x 6" MIPT x MIPT Flex Riser	100	42LS	
FR-0500-6F	1/2" x 6" MIPT x FIPT Flex Riser	100	42LS	
FR-0750-6	3/4" x 6" MIPT x MIPT Flex Riser	50	42LS	
FR-1000-7	1" x 7" MIPT x MIPT Flex Riser	25	42LS	
<b>Cutoff Riser Extension</b>				
CRE-0500-3	1/2" x 3" FIPT x MIPT Cutoff Riser Extension	200	42LS	Rated @ 70 PSI @ 72°F
CRE-0750-4	3/4" x 4" FIPT x MIPT Cutoff Riser Extension	200	42LS	
<b>Swing Pipe Fittings</b>				
FPA-0500	Swing Pipe Adapter .490BARB x 1/2"	50	42LS	
FPA-0750	3/4" Swing Pipe Adapter	250	42LS	
FPC-0490	.49" Swing Pipe Connector	250	42LS	
FPE-0500	1/2" Swing Pipe Elbow	400	42LS	
FPE-0500F	1/2" Swing Pipe Elbow FPT x Spiral Barb	400	42LS	
FPE-0750	3/4" Swing Pipe Elbow	250	42LS	
FPT-0500	1/2" Swing Pipe Tee	500	42LS	
<b>Shrub Adapter</b>				
SAM-0500	1/2" Male Sprinkler Adapter	50	42LS	Rated @ 70 PSI @ 72°F

## Index, Flow Management

Part No.	Page	Part No.	Page	Part No.	Page	Part No.	Page	Part No.	Page
22-040	134	731-20*	117	1011C20	121	1520C12	126	321507P	136
23-25T	134	731-71	117	1012-05	121	1520C15	126	321510P	136
112-1	118	733-07	117	1012-07	121	1520C15F	126	322010P	136
112-05	118	733-10	117	1012-10	121	1520C20	126	331510P	136
112-07	118	733-12	117	1012-12	121	1520C20F	126	332007P	136
112-10	118	733-15	117	1012-15	121	1520C30	126	332010P	136
112-15	118	733-20*	117	1012-20	121	1520C40	126	344007P	136
112-20	118	733-71	117	1012-25	121	1520V20	125	421507	136
118-05	120	810-07	116	1012-30	121	1700-15	122	421510	136
118-07	120	810-10	116	1050C10	123	1700-20	122	422007	136
118-10	120	830-07	116	1050C20	123	1700C10	122	422010	136
118-12	120	830-10	116	1053C20	123	1700C15	122	422012	136
118-15	120	830-71	116	1055C20	123	1700C20	122	422015	136
118-20	120	830-121	116	1205-05	123	1702-15	122	422507	136
118-25	120	831-07	116	1205-07	123	1702-20	122	422515	136
118-30	120	831-10	116	1205-07-20	123	1720-10	127	422520	136
118-40	120	833-07	116	1205-10	123	1720-15	127	432007	136
118-60QF	120	833-10	116	1205-12	123	1720-20	127	432010	136
135-05	118	833-71	116	1205-15	123	1720C07	127	432012	136
135-07	118	935-07	119	1205-20	123	1720C10	127	432015	136
135-10	118	935-10	119	1225-10	123	1720C15	127	432510	136
135-12	118	935-20	119	1225-15	123	1720C20	127	432515	136
135-15	118	935-125	119	1400-15	128	1720C30	127	432520	136
135-20	118	1001-05	121	1500-12	125	1790-15	122	443007	137
136-05	118	1001-07	121	1500-15	125	1790-20	122	443010	137
136-07	118	1001-10	121	1500-20	125	1790C15	122	443012	137
136-10	118	1001-12	121	1500-30	125	1790C20	122	443015	137
235-05	119	1001-15	121	1500C15	125	1795C20	122	443020	137
235-10	119	1001-15FV	120	1500C20	125	1800-10	120	444007	137
235-15	119	1001-20	121	1520-05	125	1800-12	120	444010	137
235-20	119	1001-20FV	120	1520-05F	125	1800-15	120	444012	137
710-07	117	1001-30	121	1520-07	125	1800-20	120	444015	137
710-10	117	1002-07	121	1520-07F	125	2200-15	128	444020	137
710-12	117	1002-10	121	1520-10	125	2200-15TU	128	446007	137
710-15*	117	1002-12	121	1520-10F	125	2200-15UC	128	446010	137
710-17	117	1002-15	121	1520-12	125	2200-20	128	446015	137
710-17-9	117	1002-20	121	1520-12F	125	2200-20TU	128	446020	137
710-20*	117	1002-25	121	1520-15	125	2200-20UC	128	448010	137
730-07	117	1002-30	121	1520-15F	125	3115	135	448015	137
730-10	117	1010-05-O	124	1520-20	125	3120	135	448020	137
730-12	117	1010-07-O	124	1520-20F	125	3125	135	453007	137
730-15	117	1011-05	121	1520-30	125	3130	135	453010	137
730-20*	117	1011-07	121	1520-40	125	3140	135	453012	137
730-71	117	1011-10	121	1520C05	126	3160	135	453015	137
731-07	117	1011-12	121	1520C05F	126	3220	135	453020	137
731-10	117	1011-15	121	1520C07	126	3225	135	454010	137
731-12	117	1011-20	121	1520C07F	126	3230	135	454015	137
731-12-10	117	1011-30	121	1520C10	126	3240	135	454020	137
731-15	117	1011C10	121	1520C10F	126	3260	135	456010	137

## Index, Flow Management

Part No.	Page	Part No.	Page	Part No.	Page	Part No.	Page	Part No.	Page
456015	137	CPT-0500-S	114	E1410-12	130	KSL-0750-S	127	WU-1250-S	134
456020	137	CPT-0750-S	114	E1410-15	130	KSL-1000-S	127	WU-1250-T	134
458015	137	CPT-0750-T	114	E1410-20	130	KSL-1500-S	127	WU-1500-S	134
458020	137	CPT-1000-S	114	E1410-25	130	KSL-2000-S	127	WU-1500-T	134
BTU-0500-HL	132	CPT-1000-T	114	E1410-30	130	S1050C20	123	WU-2000-S	134
BTU-0750-E	132	CPT-1250-S	114	E1410-40	130	SAM-0500	139	WU-2000-T	134
BTU-0750-HL	132	CPT-1250-T	114	E1420-05	130	SW-0500-C	115	WU-3000-S	134
BTU-1000-E	132	CPT-1500-S	114	E1420-07	130	TSA-0500-TT	138	WU-4000-S	134
BTU-1000-HL	132	CPT-1500-T	114	E1420-10	130	TSA-0750-ST	138		
BTU-1250-E	132	CPT-2000-S	114	E1420-12	130	TSA-0750-TT	138		
BTU-1250-HL	132	CPT-2000-T	114	E1420-15	130	TSA-1000-ST	138		
BTU-1500-E	132	CRE-0500-3	139	E1420-20	130	TSA-1000-TT	138		
BTU-1500-HL	132	CRE-0750-4	139	E1420-25	130	TSA-1500-TT	138		
BTU-2000-E	132	CV-0500-FF	124	E1420-30	130	U-0500-S	133		
BTU-2000-HL	132	CV-0500-FM	124	E1420-40	130	U-0500-SM	133		
BTU-2500-SE	132	CV-0500-MF	124	E1610-05	131	U-0500-T	133		
BTU-2500-TE	132	CV-0750-FF	124	E1610-07	131	U-0750-S	133		
BTU-3000-SE	132	CV-0750-MF	124	E1610-10	131	U-0750-SM	133		
C1310-05	132	CV-1000-FF	124	E1610-12	131	U-0750-T	133		
C1310-07	132	CV-1000-MF	124	E1610-15	131	U-1000-S	133		
C1310-10	132	E1310-05	129	E1610-20	131	U-1000-SM	133		
C1310-12	132	E1310-07	129	E1610-60	131	U-1000-T	133		
C1310-15	132	E1310-10	129	E1620-05	131	U-1000-TM	133		
C1310-20	132	E1310-12	129	E1620-07	131	U-1250-S	133		
CCC-0500	115	E1310-15	129	E1620-10	131	U-1250-T	133		
CCC-0750	115	E1310-20	129	E1620-12	131	U-1500-S	133		
CCC-1000	115	E1310-25	129	E1620-15	131	U-1500-SM	133		
CPA-0750	115	E1310-30	129	E1620-20	131	U-1500-ST	133		
CPA-1000	115	E1310-40	129	FCO-0500	139	U-1500-T	133		
CPA-1250	115	E1310-60	129	FPA-0500	139	U-2000-S	133		
CPA-1500	115	E1320-05	129	FPA-0750	139	U-2000-SM	133		
CPA-2000	115	E1320-07	129	FPC-0490	139	U-2000-ST	133		
CPC-0500	114	E1320-10	129	FPE-0500	139	U-2000-T	133		
CPC-0750	114	E1320-12	129	FPE-0500F	139	U-2500-S	133		
CPC-1000	114	E1320-15	129	FPE-0750	139	U-2500-T	133		
CPC-1250	114	E1320-20	129	FPT-0500	139	U-3000-S	133		
CPC-1500	114	E1320-25	129	FR-0500-4	139	U-3000-T	133		
CPC-2000	114	E1320-30	129	FR-0500-4F	139	U-4000-S	133		
CPC-2500	114	E1320-40	129	FR-0500-6	139	U-4000-T	133		
CPC-3000	114	E1410-05	130	FR-0500-6F	139	WU-0750-S	134		
CPC-4000	114	E1410-07	130	FR-0750-6	139	WU-0750-T	134		
CPC-6000	114	E1410-10	130	FR-1000-7	139	WU-1000-S	134		

For Flow Management Technical Information, Refer to Technical Specification documents at [ndspro.com/specifications](https://ndspro.com/specifications)



# Fittings & Clamps

Our comprehensive line of sewer and drain fittings includes valves, couplings and connectors in PVC and styrene. NDS continues its tradition of innovation with the patent-pending Swivel-Fit™ variable angle fitting that combines two fixed fittings into one adjustable fitting solution.



## Product Applications



### Variable Angle Fitting

As part of a complete drainage system, the adjustable Swivel-Fit™ variable-angle fitting adds a 0° to 90° turn to the pipeline as it connects two pipes of the same type and diameter size together; also adds a 0° to 90° turn from drainage product to drain pipe.



### Pool & Deck Accessories

The round grates capture light flows of water from patios, decks, and around pools; the pool backflush fitting with recessed grate captures pool backwash while keeping out pipe-clogging debris.



### Sewer and Drainage Fittings

As part of a complete drainage system, these fittings are used to direct the flow of water in drain pipe.



**Diverter and Backwater Valves**  
For septic tank leach fields, basements and low areas. NDS offers lightweight and strong solutions that are easy to install.



**Flexible Saddles**  
Patented elastomeric construction offers superior flexibility eliminating the need for large inventory of rigid PVC saddles.



**Flexible Couplings & Connectors**  
Our versatile couplings and connectors ensure leakproof seals with any pipe material, making connections quick and easy for sewer, drain, waste, and vent piping.



**Clamps**  
Pipe clamps for plumbing, irrigation and drainage are corrosion-resistant and easy to install.



**Manhole Cover Adapters**  
These adapters are designed for concrete manholes, made of PVC and available for 4 in., 6 in., and 8 in. pipes. They help prevent leaks and allow for lateral pipe movement without compromising seal integrity.

## Solvent-Weld Sewer & Drain Fittings

### Swivel-Fit™ Variable-Angled Fitting, Patent Pending



Part No.	Description	Color	Pkg. Qty.	Wt. Ea. (lbs.)	Product Class
4PVAF	PVC S&D Swivel-Fit™ 0-90° Variable-Angled Fitting, 4 in. Hub X Hub	White	12	1.00	30PV

### Tee

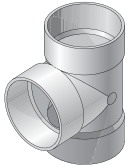

Part No.	Description	Color	Pkg. Qty.	Wt. Ea. (lbs.)	Product Class
3P01	PVC S&D Tee, 3 in. Hub X Hub X Hub	White	35	0.57	30PV
4P01	PVC S&D Tee, 4 in. Hub X Hub X Hub	White	20	0.95	30PV
6P01	PVC S&D Tee, 6 in. Hub X Hub X Hub	White	9	3.66	30PV
64P01	PVC S&D Tee, 6 in. Hub X Hub X 4 in. Hub	White	8	2.38	30PV
8P01	PVC S&D Tee, 8 in. Hub X Hub X Hub	White	2	3.00	30PV
84P01	PVC S&D Tee, 8 in. Hub X Hub X 4 in. Hub	White	7	4.72	30PV
86P01	PVC S&D Tee, 8 in. Hub X Hub X 6 in. Hub	White	3	5.00	30PV

### Double Cleanout

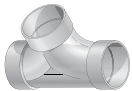

Part No.	Description	Color	Pkg. Qty.	Wt. Ea. (lbs.)	Product Class
417P	PVC S&D Double Cleanout, 4 in. Hub X Hub X Hub	White	24	1.41	30PV



## 90 Degree Elbow

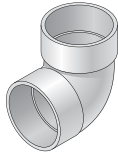

Part No.	Description	Color	Pkg. Qty.	Wt. Ea. (lbs.)	Product Class
3P02	PVC S&D 90° Elbow, 3 in. Hub X Hub	White	40	0.40	30PV
4P02	PVC S&D 90° Elbow, 4 in. Hub X Hub	White	25	0.68	30PV
6P02	PVC S&D 90° Elbow, 6 in. Hub X Hub	White	6	3.00	30PV
8P02	PVC S&D 90° Elbow, 8 in. Hub X Hub	White	4	6.50	30PV

## 90 Degree Long-Turn Elbow

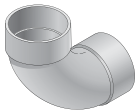

Part No.	Description	Color	Pkg. Qty.	Wt. Ea. (lbs.)	Product Class
31P0	PVC S&D 90° Long-Turn Elbow, 3 in. Hub X Hub	White	30	0.46	30PV
41P0	PVC S&D 90° Long-Turn Elbow, 4 in. Hub X Hub	White	20	0.85	30PV
61P0	PVC S&D 90° Long-Turn Elbow, 6 in. Hub X Hub	White	8	3.10	30PV

## 90 Degree Long-Turn Street Elbow

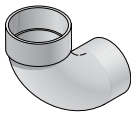

Part No.	Description	Color	Pkg. Qty.	Wt. Ea. (lbs.)	Product Class
31POST	PVC S&D 90° Long-Turn Street Elbow, 3 in. Hub X Spt	White	20	0.90	30PV
41POST	PVC S&D 90° Long-Turn Street Elbow, 4 in. Hub X Spt	White	20	1.25	30PV

## 45 Degree Elbow

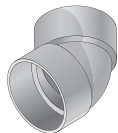

Part No.	Description	Color	Pkg. Qty.	Wt. Ea. (lbs.)	Product Class
3P03	PVC S&D 45° Elbow, 3 in. Hub X Hub	White	40	0.32	30PV
4P03	PVC S&D 45° Elbow, 4 in. Hub X Hub	White	30	0.53	30PV
6P03	PVC S&D 45° Elbow, 6 in. Hub X Hub	White	8	2.12	30PV
8P03	PVC S&D 45° Elbow, 8 in. Hub X Hub	White	6	4.33	30PV

## Solvent-Weld Sewer & Drain Fittings

### 45 Degree Street Elbow

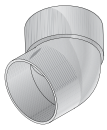

Part No.	Description	Color	Pkg. Qty.	Wt. Ea. (lbs.)	Product Class
3P03ST	PVC S&D 45° Street Elbow, 3 in. Hub X Spt	White	30	0.33	30PV
4P03ST	PVC S&D 45° Street Elbow, 4 in. Hub X Spt	White	30	0.86	30PV
6P03ST	PVC S&D 45° Street Elbow, 6 in. Hub X Spt	White	10	1.80	30PV

### 22-1/2 Degree Elbow

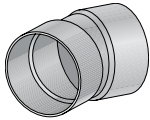

Part No.	Description	Color	Pkg. Qty.	Wt. Ea. (lbs.)	Product Class
3P04	PVC S&D 22.5° Elbow, 3 in. Hub X Hub	White	25	0.32	30PV
4P04	PVC S&D 22.5° Elbow, 4 in. Hub X Hub	White	20	0.45	30PV
6P04	PVC S&D 22.5° Elbow, 6 in. Hub X Hub	White	20	1.60	30PV

### Coupling

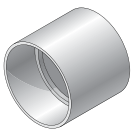

Part No.	Description	Color	Pkg. Qty.	Wt. Ea. (lbs.)	Product Class
3P05	PVC S&D Coupling, 3 in. Hub X Hub	White	120	0.22	30PV
4P05	PVC S&D Coupling, 4 in. Hub X Hub	White	45	0.37	30PV
6P05	PVC S&D Coupling, 6 in. Hub X Hub	White	10	1.30	30PV
8P05	PVC S&D Coupling, 8 in. Hub X Hub	White	6	3.33	30PV

### Slip Repair Coupling

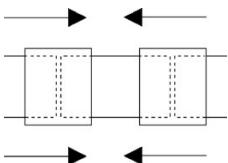

Part No.	Description	Color	Pkg. Qty.	Wt. Ea. (lbs.)	Product Class
3P05R	PVC S&D Slip Repair Coupling, 3 in. Hub X Hub	White	60	0.25	30PV
4P05R	PVC S&D Slip Repair Coupling, 4 in. Hub X Hub	White	45	0.46	30PV

## Increaser/Reducer Bushing



Part No.	Description	Color	Pkg. Qty.	Wt. Ea. (lbs.)	Product Class
3P07	PVC S&D Increaser/Reducer Bushing, 3 in. Hub X 4 in. Spt	White	20	0.45	30PV
6P07S	PVC S&D Increaser/Reducer Bushing, 4 in. Hub X 6 in. Spt	White	20	1.10	30PV

## Increaser/Reducer Coupling

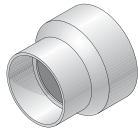

Part No.	Description	Color	Pkg. Qty.	Wt. Ea. (lbs.)	Product Class
4P07	PVC S&D Increaser/Reducer Coupling, 3 in. Hub X 4 in. Hub	White	30	0.36	30PV
6P07	PVC S&D Increaser/Reducer Coupling, 4 in. Hub X 6 in. Hub	White	20	1.10	30PV
8P07	PVC S&D Increaser/Reducer Coupling, 6 in. Hub X 8 in. Hub	White	1	3.00	30PV

## 45 Degree Wye

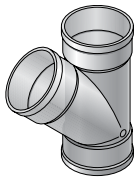

Part No.	Description	Color	Pkg. Qty.	Wt. Ea. (lbs.)	Product Class
3P08	PVC S&D 45° Wye, 3 in. Hub X Hub X Hub	White	25	0.88	30PV
4P08	PVC S&D 45° Wye, 4 in. Hub X Hub X Hub	White	20	1.25	30PV
6P08	PVC S&D 45° Wye, 6 in. Hub X Hub X Hub	White	6	4.66	30PV
64P08	PVC S&D 45° Wye, 6 in. Hub X Hub X 4 in. Hub	White	8	2.88	30PV
8P08	PVC S&D 45° Wye, 8 in. Hub X Hub X Hub	White	2	11.00	30PV
84P08	PVC S&D 45° Wye, 8 in. Hub X Hub X 4 in. Hub	White	6	5.33	30PV
86P08	PVC S&D 45° Wye, 8 in. Hub X Hub X 6 in. Hub	White	3	3.33	30PV

## Sanitary (Sweep) Tee



Part No.	Description	Color	Pkg. Qty.	Wt. Ea. (lbs.)	Product Class
3P09	PVC S&D Sanitary Tee, 3 in. Hub X Hub X Hub	White	30	0.66	30PV
4P09	PVC S&D Sanitary Tee, 4 in. Hub X Hub X Hub	White	20	1.60	30PV
6P09	PVC S&D Sanitary Tee, 6 in. Hub X Hub X Hub	White	5	4.20	30PV
8P09	PVC S&D Sanitary Tee, 8 in. Hub X Hub X Hub	White	1	15.00	30PV

## Cap

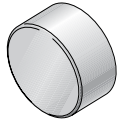

Part No.	Description	Color	Pkg. Qty.	Wt. Ea. (lbs.)	Product Class
3P06	PVC S&D Cap, 3 in. Hub	White	25	0.20	30PV
4P06	PVC S&D Cap, 4 in. Hub	White	25	0.28	30PV
6P06	PVC S&D Cap, 6 in. Hub	White	30	0.93	30PV
8P06	PVC S&D Cap, 8 in. Hub	White	10	2.40	30PV

## Female Cleanout Adapter



Part No.	Description	Color	Pkg. Qty.	Wt. Ea. (lbs.)	Product Class
3P11	PVC S&D Female Cleanout Adapter, 3 in. Hub X FPT	White	25	0.36	30PV
4P11	PVC S&D Female Cleanout Adapter, 4 in. Hub X FPT	White	20	0.55	30PV
613P	PVC S&D Female Cleanout Adapter, 6 in. Hub X FPT	White	24	1.08	30PV

## Female Fitting Cleanout Adapter



Part No.	Description	Color	Pkg. Qty.	Wt. Ea. (lbs.)	Product Class
413P	PVC S&D Female Fitting Cleanout Adapter, 4 in. Spt X FPT	White	20	0.50	30PV

## Cleanout Plug

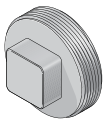

Part No.	Description	Color	Pkg. Qty.	Wt. Ea. (lbs.)	Product Class
31P8	PVC S&D Cleanout Plug, 3 in. MPT	White	50	0.30	30PV
41P8	PVC S&D Cleanout Plug, 4 in. MPT	White	30	0.36	30PV
61P8	PVC S&D Cleanout Plug, 6 in. MPT	White	24	0.62	30PV

## Cross



Part No.	Description	Color	Pkg. Qty.	Wt. Ea. (lbs.)	Product Class
4P1X	PVC S&D Cross, 4 in. Hub X Hub X Hub X Hub	White	20	1.40	30PV

## Adapters

### Adapter (DWV/SCH40 to S&D)

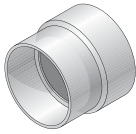

Part No.	Description	Color	Pkg. Qty.	Wt. Ea. (lbs.)	Product Class
3P15	PVC Adapter, 3 in. DWV/SCH40 Hub X S&D Hub	White	60	0.35	30PV
3P16	PVC Adapter, 4 in. DWV/SCH40 Hub X S&D Hub	White	30	0.80	30PV

### Adapter Bushing (DWV/SCH40 to S&D)



Part No.	Description	Color	Pkg. Qty.	Wt. Ea. (lbs.)	Product Class
2P41	PVC Adapter Bushing, 3 in. DWV/SCH40 Spt X S&D Hub	White	50	0.12	30PV
2P42	PVC Adapter Bushing, 4 in. DWV/SCH40 Spt X S&D Hub	White	25	0.24	30PV
2P43	PVC Adapter Bushing, 6 in. DWV/SCH40 Spt X S&D Hub	White	20	0.70	30PV

### Increaser/Reducer Adapter (DWV/SCH40 to S&D)

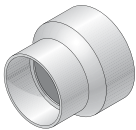

Part No.	Description	Color	Pkg. Qty.	Wt. Ea. (lbs.)	Product Class
533	PVC Increaser/Reducer Adapter, 2 in. DWV/SCH40 Hub X 4 in. S&D Spt	White	20	0.35	30PV
3P12	PVC Increaser/Reducer Adapter, 3 in. DWV/SCH40 Hub X 4 in. S&D Hub	White	50	0.50	30PV
3P17	PVC Increaser/Reducer Adapter, 3 in. DWV/SCH40 Hub X 4 in. S&D Spt	White	30	0.35	30PV

## Increaser/Reducer Adapter Bushing (DWV/SCH40 to S&D)



Part No.	Description	Color	Pkg. Qty.	Wt. Ea. (lbs.)	Product Class
532	PVC Increaser/Reducer Adapter Bushing, 2 in. DWV/SCH40 Hub X 3 in. S&D Spt	White	20	0.20	30PV

## Downspout Adapter for Sewer & Drain Pipe

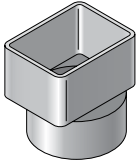

Part No.	Description	Color	Pkg. Qty.	Wt. Ea. (lbs.)	Product Class
9P03	PVC Offset Downspout Adapter, 2X3 in. Downspout X 3 in. S&D Hub	White	40	0.42	30PV
9P04	PVC Offset Downspout Adapter, 2X3 in. Downspout X 4 in. S&D Hub	White	30	0.53	30PV
9P06	PVC Downspout Adapter, 3X4 in. Downspout X 4 in. S&D Hub	White	25	0.50	30PV
9P10	PVC Offset Downspout Adapter, 4X6 in. Downspout X 6 in. S&D Hub	White	15	1.00	30PV
9P13	PVC Offset Downspout Adapter, 3X4 in. Downspout X 4 in. S&D Hub	White	25	0.50	30PV

## Downspout Adapter for DWV/Schedule 40 Pipe

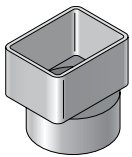

Part No.	Description	Color	Pkg. Qty.	Wt. Ea. (lbs.)	Product Class
9P07	PVC Downspout Adapter, 2X3 in. Downspout X 3 in. DWV/SCH40 Hub	White	40	0.30	30PV
9P08	PVC Downspout Adapter, 2X3 in. Downspout X 4 in. DWV/SCH40 Hub	White	30	1.10	30PV
9P09	PVC Downspout Adapter, 3X4 in. Downspout X 4 in. DWV/SCH40 Hub	White	30	0.44	30PV

**Pool Accessories**

**Drain Grate**



Part No.	Description	Color	Pkg. Qty.	Wt. Ea. (lbs.)	Product Class
9P12	3 in. PVC Round Grate, Fits 3 in. Sewer & Drain Fittings	White	50	0.16	30PV
9P11	4 in. PVC Round Grate, Fits 4 in. Sewer & Drain Fittings	White	25	0.36	30PV

**Deck Drain**



Part No.	Description	Color	Pkg. Qty.	Wt. Ea. (lbs.)	Product Class
WC100	HIPS S&D Deck Drain, 3 in. Hub	White	50	0.16	30ST
WC100G	HIPS S&D Deck Drain, 3 in. Hub	Gray	50	0.16	30ST
WC100T	HIPS S&D Deck Drain, 3 in. Hub	Tan	50	0.16	30ST

**Pool Backflush Fitting**

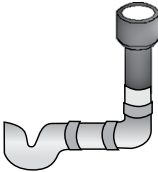

Part No.	Description	Color	Pkg. Qty.	Wt. Ea. (lbs.)	Product Class
650	HDPE Pool Backflush Fitting with Recessed Grate, 4 in. tapered Spt (Includes removable 4" grate NDS #11)	Black	35	0.16	30ST

## Corrugated Fittings

### Coupling



Part No.	Description	Color	Pkg. Qty.	Wt. Ea. (lbs.)	Product Class
3C05	HDPE Internal Coupling, 3 in.	Black	60	0.30	11RP
4C07	HDPE Internal Coupling, 4 in.	Black	36	0.30	11RP
6C05	HDPE Internal Coupling, 6 in.	Black	12	0.80	11RP

### End Cap



Part No.	Description	Color	Pkg. Qty.	Wt. Ea. (lbs.)	Product Class
3C06	HDPE End Cap, 3 in.		33	0.30	11RP
4C06	HDPE End Cap, 4 in.	Black	32	0.50	11RP
6C06	HDPE End Cap, 6 in.	Black	15	0.50	11RP

### Adapter

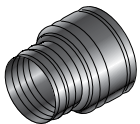

Part No.	Description	Color	Pkg. Qty.	Wt. Ea. (lbs.)	Product Class
351	HDPE Corrugated Adapter, 3 in. Drain Pipes & Fittings Spt X 3 in. Corr. Hub	Black	50	0.10	30PV
451	HDPE Corrugated Adapter, 4 in. Drain Pipes & Fittings Spt X 4 in. Corr. Hub	Black	25	0.20	30PV
651	HDPE Corrugated Adapter, 6 in. Drain Pipes & Fittings Spt X 6 in. Corr. Hub	Black	12	0.25	30PV

### Downspout Adapter



Part No.	Description	Color	Pkg. Qty.	Wt. Ea. (lbs.)	Product Class
234CDS	HDPE Downspout Adapter,   2X3 in. Downspout X 4 in. Corr. Hub	Black	24	0.20	30ST
344CDS	HDPE Downspout Adapter, 3X4 in. Downspout X 4 in. Corr. Hub	Black	24	0.20	30ST



## Diverter & Backwater Valves

### Diverter Valve

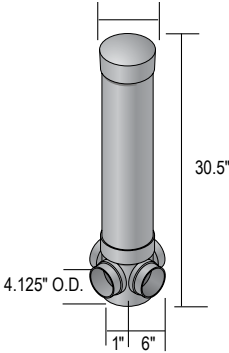

Part No.	Description	Color	Pkg. Qty.	Wt. Ea. (lbs.)	Product Class
575P	<b>PVC*</b> 4" PVC Diverter Valve	White	4	9.50	35PV
575	<b>ABS*</b> 4" ABS Diverter Valve	Black	4	7.50	35AB

\*IAPMO Listed

### Gravity Backwater Valve

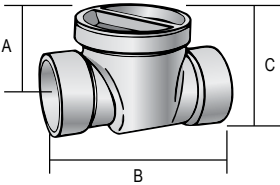

Part No.	A	B	C	Riser Height	Riser Diameter
275P, 275	2.18"	5.03"	3.53"	16"	4"
375P, 375	3.51"	7.56"	6.10"	16"	6"
375PR	3.51"	7.56"	6.10"	16"	6"
475P, 475	4.47"	11.18"	7.18"	16"	8"
475PR	4.47"	11.18"	7.18"	16"	8"
675P, 675	5.50"	15.25"	9.90"	16"	10"

\*Approvals applicable to valve only.



## Diverter & Backwater Valves

### Backwater Valve



Part No.	Description	Color	Pkg. Qty.	Wt. Ea. (lbs.)	Product Class
275P	2" PVC Backwater Valve	White	8	1.00	35PV
375P	3" PVC Backwater Valve	White	6	2.33	35PV
375PR	3" PVC Backwater Valve with Riser and Cover	White	1	5.00	35PV
475P	4" PVC Backwater Valve	White	6	4.33	35PV
475PR	4" PVC Backwater Valve with Riser and Cover	White	1	8.00	35PV
675P	6" PVC Backwater Valve	White	1	9.00	35PV
275	2" ABS Backwater Valve	Black	8	1.00	35AB
375	3" ABS Backwater Valve	Black	6	1.83	35AB
475	4" ABS Backwater Valve	Black	6	3.33	35AB
675	6" ABS Backwater Valve and Cover	Black	1	7.00	35AB

### Backwater Valve Box

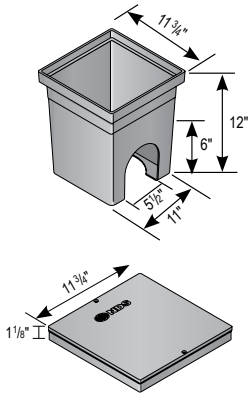

Part No.	Description	Color	Pkg. Qty.	Wt. Ea. (lbs.)	Product Class
1219	12" x 12" Backwater Valve Box	Black	4	5.75	10ND
1220	12" x 12" Valve Box Cover	Black	8	2.00	10ND

## Flexible Couplings & Connectors

### Flexible Coupling Sizing Chart

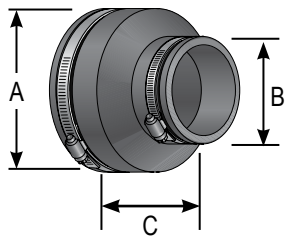

- All dimensions given in inches and mm.
- Couplings available to connect 1-1/4" to 15" pipe.
- 300 Series stainless steel clamps supplied with all couplings.
- All couplings will fit any pipe type within +/- 5% OD on chart.

#### Clay to Clay

Part No.	A		B		C		Pkg. Qty.	Weight	Product Class
	Inches	mm	Inches	mm	Inches	mm			
01-44	5.25	133	5.25	133	4.00	101	18	1.27	45CO

#### Clay to Cast Iron or Plastic

Part No.	A		B		C		Pkg. Qty.	Weight	Product Class
	Inches	mm	Inches	mm	Inches	mm			
02-43	5.25	133	3.38	85	4.00	101	36	1.25	45CO
02-44	5.25	133	4.38	111	4.00	101	24	1.04	45CO
02-55	USE PART NO. 56-65								
02-64	7.38	187	4.38	111	6.00	152	12	2.50	45CO
02-66	7.38	187	6.38	162	6.00	152	18	2.38	45CO
02-88	9.65	245	8.50	215	6.00	152	6	3.16	45CO

#### Concrete to Cast Iron or Plastic

Part No.	A		B		C		Pkg. Qty.	Weight	Product Class
	Inches	mm	Inches	mm	Inches	mm			
06-44	5.62	142	4.38	111	4.00	101	18	1.66	45CO
06-64	7.80	198	4.38	111	6.00	152	12	2.41	45CO
06-66	7.80	198	6.38	162	6.00	152	12	2.58	45CO
06-88	10.25	260	8.50	215	6.00	152	6	3.33	45CO

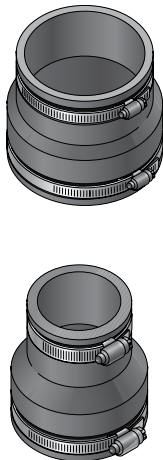

## Flexible Coupling Sizing Chart

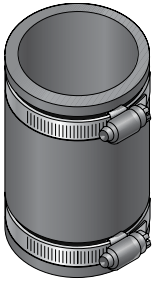

### Asbestos Cement, Fibre or Ductile Iron to Cast Iron or Plastic

Part No.	A		B		C		Pkg. Qty.	Weight	Product Class
	Inches	mm	Inches	mm	Inches	mm			
51-44	4.75	120	4.38	111	4.00	101	24	1.08	45CO
51-66	7.00	177	6.38	162	6.00	152	15	2.73	45CO

### Cast Iron, Plastic, Copper, Steel or Lead to Cast Iron, Plastic, Copper, Steel or Lead

Part No.	A		B		C		Pkg. Qty.	Weight	Product Class
	Inches	mm	Inches	mm	Inches	mm			
56-125	1.65	40	1.65	40	4.00	101	90	0.36	45CO
56-150/125	1.90	48	1.65	40	4.00	101	75	0.41	45CO
56-150	1.90	48	1.90	48	4.00	101	75	0.41	45CO
56-2150	2.40	60	1.90	48	4.00	101	54	0.51	45CO
56-22	2.40	60	2.40	60	4.00	101	54	0.50	45CO
56-32	3.38	85	2.40	60	4.00	101	45	0.71	45CO
56-33	3.38	85	3.38	85	4.00	101	45	0.75	45CO
56-42	4.38	111	2.40	60	4.00	101	30	0.93	45CO
56-E43	4.38	111	3.38	85	4.00	101	24	1.37	45CO
56-43	4.38	111	3.38	85	4.00	101	25	1.08	45CO
56-44	4.42	112	4.42	112	4.00	101	24	1.66	45CO
56-E64	6.38	162	4.38	111	6.00	152	10	2.20	45CO
56-64	6.38	162	4.38	111	6.00	152	12	2.16	45CO
56-66	6.38	162	6.38	162	6.00	152	15	2.13	45CO
56-86	8.50	215	6.38	162	6.00	152	8	3.37	45CO
56-88	8.50	215	8.50	215	6.00	152	12	3.50	45CO
56-1010	10.60	269	10.60	269	7.00	178	2	6.00	45CO
56-1212	12.83	326	12.83	326	6.00	152	3	5.00	45CO

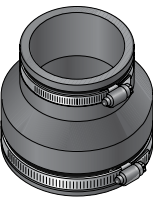
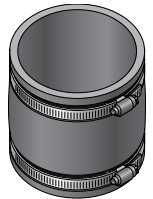

## Drain and Trap Connectors

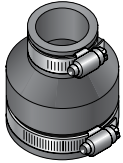

Part No.	Description	Color	Pkg. Qty.	Wt. Ea. (lbs.)	Product Class
57-125	1-1/4" or 1-1/2" Drain Piping x 1-1/4" or 1-1/2" Drain Piping	Black	180	0.17	45CO
57-150/125	1-1/2" DWV or 1-1/2" Copper x 1-1/4" or 1-1/2" Drain Piping	Black	120	0.25	45CO

## Large Diameter Couplings

Large Diameter Couplings are available through NDS. The large couplings are engineered for use with all the common pipe material: clay, concrete, cast iron, plastic, fiberglass, ductile iron and asbestos/cement. When ordering please remember to provide the exact O.D. size in inches for both pipes. A difference of 6" between the two pipe O.D. sizes cannot be made. Please call for details 1-800-726-1994.

## Expansion Joints

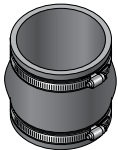

Part No.	Description	Color	Pkg. Qty.	Wt. Ea. (lbs.)	Product Class
XJ3	3" Expansion Joints	Black	24	0.67	45CO

### Clamps for Flexible Couplings

#### CLAMP MIN. & MAX. DIAMETERS & OVERALL LENGTH

Part No.	Max. Dia.	Min. Dia.	Length	Color	Pkg. Qty.	Wt. Ea. (lbs.)	Product Class
33H040 CLAMP	3.00"	2.06"	10-3/8"	Stainless Steel	400	0.05	45CO
33H250 CLAMP	12.62"	8.75"	40-1/2"	Stainless Steel	100	0.25	45CO
33S248 CLAMP	16"	3.625"	51-1/2"	Stainless Steel	100	0.25	45FS

## Concrete Manhole Cover Adapters

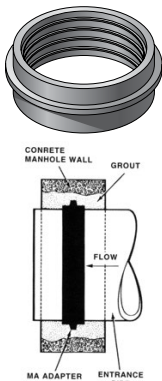

Part No.	Description	Color	Pkg. Qty.	Wt. Ea. (lbs.)	Product Class
4MA	4" Manhole Adapter	Black	24	1.00	45CO
6MA	6" Manhole Adapter	Black	24	0.62	45CO
8MA	8" Manhole Adapter	Black	14	1.00	45CO

## Flexible Saddles

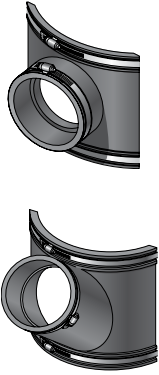

Part No.	Description	Color	Pkg. Qty.	Wt. Ea. (lbs.)	Product Class
4T/C	4" Tees with Clamps	Black	12	3.16	45FS
4T/WOC	4" Tees without Clamps	Black	12	2.66	45FS
4Y/C	4" Wyes with Clamps	Black	6	7.66	45FS
4Y/WOC	4" Wyes without Clamps	Black	6	7.12	45FS
6T/C	6" Tees with Clamps	Black	6	6.50	45FS
6T/WOC	6" Tees without Clamps	Black	6	6.0	45FS
6Y/C	6" Wyes with Clamps	Black	4	9.9	45FS
6Y/WOC	6" Flex Wye without Clamps	Black	4	11.75	45FS

## Saddle Clamps

Part No.	Description	Color	Pkg. Qty.	Wt. Ea. (lbs.)	Product Class
33S248 CLAMP	Clamp for Flexible Coupling	Stainless Steel	100	0.25	45FS

### ASTM Material Specifications

Test	NDS Material	ASTM Test Material
Chemical Resistance 1N sulfuric acid 1N hydrochloric acid	No weight loss No weight loss	D543
Tensile Strength Elongation	1000 psi (7Mpa) min. 200% min. elongation @ break	D412 Die "C"
Duration Hardness	Shore durometer 50 min. to 75 max.	D2240
Compression Set	30% max. of original deflection	D395, Method B Type 2
Water Absorption	5% max.	D471, immersed 7 days @158 Method A
Ozone Resistance	No visible cracking under 7x magnification	D1149, D518 Method A
Oven Aging	75% min. of original tensile strength 65% min. of original elongation	D573 (158°F for 70 hours)
Cold Brittleness	Cold brittleness was determined to be -43°C	D476
Tear Strength	125 lbs./in.	D624 Die "C"

Clamps

Stainless Steel Pinch “Crimp” Hose Clamps



Part No.	Description	Pkg Qty.	Case Qty.	Product Class
NC-155000-009	170R SS Crimp Clamp	100	100	45PC
NC-155000-010	185R 23/32" SS Crimp Clamp	100	3000	45PC
NC-155000-011	198R 5/8" SS Crimp Clamp	100	3000	45PC
NC-155000-012	210R 13/16" SS Crimp Clamp	100	2500	45PC
NC-155000-013	226R SS Crimp Clamp	100	100	45PC
NC-155000-015	256R 3/4" SS Crimp Clamp	100	100	45PC
NC-155000-016	271R 3/4" SS Crimp Clamp	100	2000	45PC
NC-155000-019	316R 15/16" SS Crimp Clamp	100	2000	45PC
NC-155000-020	331R 1" SS Crimp Clamp	100	2000	45PC
NC-155000-021	346R 1-3/8" SS Crimp Clamp	100	1500	45PC
NC-155000-027	425R 1-1/4" SS Crimp Clamp	80	1500	45PC
NC-155000-031	485R 1-7/8" SS Crimp Clamp	50	1500	45PC

Stainless Steel Pinch Clamp Crimp Tool



Part No.	Description	Pkg Qty.	Carton Qty.	Product Class
NCT-1098	Standard Jaw Crimp Tool	1	10	45PC

## Worm Drive Hose Clamps



Part No.	Description	Pkg Qty.	Case Qty.	Product Class
3604	SAE 6, 5/16" Band Width, Effective Diameter Range: 7/16" Min., 25/32" Max.	10	200	45HC
3606	SAE 8, 5/16" Band Width, Effective Diameter Range: 1/2" Min., 29/32" Max.	10	200	45HC
64006H	SAE 6, 1/2" Band Width, Effective Diameter Range: 7/16" Min., 25/32" Max.	10	200	45HC
64008H	SAE 8, 1/2" Band Width, Effective Diameter Range: 1/2" Min., 29/32" Max.	10	200	45HC
64010H	SAE 10, 1/2" Band Width, Effective Diameter Range: 9/16" Min., 1-1/8" Max.	10	500	45HC
64012H	SAE 12, 1/2" Band Width, Effective Diameter Range: 11/16" Min., 1-1/4" Max.	10	500	45HC
64016H	SAE 16, 1/2" Band Width, Effective Diameter Range: 13/16" Min., 1-1/2" Max.	10	500	45HC
64020H	SAE 20, 1/2" Band Width, Effective Diameter Range: 13/16" Min., 1-3/4" Max.	10	500	45HC
64024H	SAE 24, 1/2" Band Width, Effective Diameter Range: 1-1/16" Min., 2" Max.	10	500	45HC
64028H	SAE 28, 1/2" Band Width, Effective Diameter Range: 1-5/16" Min., 2-1/4" Max.	10	500	45HC
64032H	SAE 32, 1/2" Band Width, Effective Diameter Range: 1-9/16" Min., 2-1/2" Max.	10	500	45HC
64036H	SAE 36, 1/2" Band Width, Effective Diameter Range: 1-13/16" Min., 2-3/4" Max.	10	500	45HC
64040H	SAE 40, 1/2" Band Width, Effective Diameter Range: 2-1/16" Min., 3" Max.	10	200	45HC
64044H	SAE 44, 1/2" Band Width, Effective Diameter Range: 2-5/16" Min., 3-1/4" Max.	10	200	45HC
64048H	SAE 48, 1/2" Band Width, Effective Diameter Range: 2-9/16" Min., 3-1/2" Max.	10	200	45HC
64052H	SAE 52, 1/2" Band Width, Effective Diameter Range: 2-13/16" Min., 3-3/4" Max.	10	200	45HC
64056H	SAE 56, 1/2" Band Width, Effective Diameter Range: 3-1/16" Min., 4" Max.	10	200	45HC
64064H	SAE 62, 1/2" Band Width, Effective Diameter Range: 3-9/16" Min., 4-1/2" Max.	10	200	45HC
64072H	SAE 72, 1/2" Band Width, Effective Diameter Range: 1-7/8" Min., 5" Max.	10	100	45HC
64080H	SAE 80, 1/2" Band Width, Effective Diameter Range: 2-1/2" Min., 5-1/2" Max.	10	100	45HC
64088H	SAE 88, 1/2" Band Width, Effective Diameter Range: 3-1/8" Min., 6" Max.	10	100	45HC
64096H	SAE 96, 1/2" Band Width, Effective Diameter Range: 3-5/8" Min., 6-1/2" Max.	10	100	45HC
64104H	SAE 104, 1/2" Band Width, Effective Diameter Range: 4-1/8" Min., 7" Max.	10	100	45HC



We put water in its place™

## Worm Drive Hose Clamps



Part No.	Description	Pkg Qty.	Case Qty.	Product Class
200 06 H	SAE 6, 9/16" Band Width, Effective Diameter Range: 7/16" Min., 25/32" Max.	10	200	45HC
200 08 H	SAE 8, 9/16" Band Width, Effective Diameter Range: 1/2" Min., 29/32" Max.	10	200	45HC
200 10 H	SAE 10, 9/16" Band Width, Effective Diameter Range: 9/16" Min., 1-1/6" Max.	10	500	45HC
200 12 H	SAE 12, 9/16" Band Width, Effective Diameter Range: 11/16" Min., 1-1/4" Max.	10	500	45HC
200 16 H	SAE 16, 9/16" Band Width, Effective Diameter Range: 13/16" Min., 1-1/2" Max.	10	500	45HC
200 20 H	SAE 20, 9/16" Band Width, Effective Diameter Range: 13/16" Min., 1-3/4" Max.	10	500	45HC
200 24 H	SAE 24, 9/16" Band Width, Effective Diameter Range: 1-1/16" Min., 2" Max.	10	500	45HC
200 28 H	SAE 28, 9/16" Band Width, Effective Diameter Range: 1-5/16" Min., 2-1/4" Max.	10	500	45HC
200 32 H	SAE 32, 9/16" Band Width, Effective Diameter Range: 1-9/16" Min., 2-1/2" Max.	10	500	45HC
200 36 H	SAE 36, 9/16" Band Width, Effective Diameter Range: 1-13/16" Min., 2-3/4" Max.	10	500	45HC
200 40 H	SAE 40, 9/16" Band Width, Effective Diameter Range: 2-1/16" Min., 3" Max.	10	200	45HC
200 44 H	SAE 44, 9/16" Band Width, Effective Diameter Range: 2-5/16" Min., 3-1/4" Max.	10	200	45HC
200 52 H	SAE 52, 9/16" Band Width, Effective Diameter Range: 2-13/16" Min., 3-3/4" Max.	10	200	45HC
200 56 H	SAE 56, 9/16" Band Width, Effective Diameter Range: 3-1/16" Min., 4" Max.	10	200	45HC
200 64 H	SAE 62, 9/16" Band Width, Effective Diameter Range: 3-9/16" Min., 4-1/2" Max.	10	200	45HC
200 72 H	SAE 72, 9/16" Band Width, Effective Diameter Range: 1-7/8" Min., 5" Max.	10	100	45HC
200 80 H	SAE 80, 9/16" Band Width, Effective Diameter Range: 2-1/2" Min., 5-1/2" Max.	10	100	45HC
200 88 H	SAE 88, 9/16" Band Width, Effective Diameter Range: 3-1/8" Min., 6" Max.	10	100	45HC
200 96 H	SAE 96, 9/16" Band Width, Effective Diameter Range: 3-5/8" Min., 6-1/2" Max.	10	100	45HC
200 104 H	SAE 104, 9/16" Band Width, Effective Diameter Range: 4-1/8" Min., 7" Max.	10	100	45HC
200 128 H	SAE 128, 9/16" Band Width, Effective Diameter Range: 5-5/8" Min., 8-1/2" Max.	10	100	45HC
200 152 H	SAE 152, 9/16" Band Width, Effective Diameter Range: 7-1/8" Min., 10" Max.	10	100	45HC
200 188 H	SAE 188, 9/16" Band Width, Effective Diameter Range: 9-3/8" Min., 12-1/4" Max.	10	100	45HC
200 212 H	SAE 212, 9/16" Band Width, Effective Diameter Range: 10-7/8" Min., 13-3/4" Max.	10	100	45HC

## Snap-All® Increaser/Reducer Transition Bushings



Part No.	Description	Carton Qty.	Weight lbs.	Product Class
31575	1-1/2" x 3/4" CU	12/144	29	45CA
30151	1-1/2" x 1" CU	12/144	23	45CA
31512	1-1/2" x 1-1/4" CU	12/144	15	45CA
31515	1-1/2" x 1-1/2" CU	12/144	12	45CA
30215	2" x 1-1/2" CU	6/72	15	45CA
20215	2" x 1-1/2" CI, STL, PVC	6/72	10	45CA
30022	2" x 2" CU, XH	6/72	7	45CA
30032	3" x 2" CU	9/108	50	45CA
30043	4" x 3" CU	5/60	40	45CA
20043	4" x 3" CI, STL, PVC	5/60	34	45CA
30044	4" x 4" CU, XH	5/60	13	45CA
20054	5" x 4" CI, STL, PVC	4/48	40	45CA
20065	6" x 5" CI, STL, PVC	1/12	14	45CA
20086	8" x 6" CI, STL, PVC	1/12	34	45CA

## Index, Fittings & Clamps

Part No.	Page	Part No.	Page	Part No.	Page	Part No.	Page	Part No.	Page
01-44	155	06-44	155	41POST	145	200 96 H	161	31515	162
02-43	155	06-64	155	51-44	156	200 104 H	161	31575	162
02-44	155	06-66	155	51-66	156	200 128 H	161	64006H	160
02-55	155	06-88	155	56-22	156	200 152 H	161	64008H	160
02-64	155	6C05	152	56-32	156	200 188 H	161	64010H	160
02-66	155	6C06	152	56-33	156	200 212 H	161	64012H	160
02-88	155	6MA	157	56-42	156	234CDS	152	64016H	160
2P41	149	6P01	144	56-43	156	275	154	64020H	160
2P42	149	6P02	145	56-44	156	275P	154	64024H	160
2P43	149	6P03	145	56-64	156	275P, 275	153	64028H	160
3C05	152	6P03ST	146	56-66	156	344CDS	152	64032H	160
3C06	152	6P04	146	56-86	156	351	152	64036H	160
3P01	144	6P05	146	56-88	156	375	154	64040H	160
3P02	145	6P06	148	56-125	156	375P	154	64044H	160
3P03	145	6P07	147	56-150	156	375P, 375	153	64048H	160
3P03ST	146	6P07S	147	56-150/125	156	375PR	153, 154	64052H	160
3P04	146	6P08	147	56-1010	156	413P	148	64056H	160
3P05	146	6P09	147	56-1212	156	417P	144	64064H	160
3P05R	146	6T/C	158	56-2150	156	451	152	64072H	160
3P06	148	6T/WOC	158	56-E43	156	475	154	64080H	160
3P07	147	6Y/C	158	56-E64	156	475P	154	64088H	160
3P08	147	6Y/WOC	158	57-125	157	475P, 475	153	64096H	160
3P09	147	8MA	157	57-150/125	157	475PR	153, 154	64104H	160
3P11	148	8P01	144	61P0	145	532	150	NC-155000-009	159
3P12	149	8P02	145	61P8	148	533	149	NC-155000-010	159
3P15	149	8P03	145	64P01	144	575	153	NC-155000-011	159
3P16	149	8P05	146	64P08	147	575P	153	NC-155000-012	159
3P17	149	8P06	148	84P01	144	613P	148	NC-155000-013	159
4C06	152	8P07	147	84P08	147	650	151	NC-155000-015	159
4C07	152	8P08	147	86P01	144	651	152	NC-155000-016	159
4MA	157	8P09	147	86P08	147	675	154	NC-155000-019	159
4P01	144	9P03	150	200 06 H	161	675P	154	NC-155000-020	159
4P1X	148	9P04	150	200 08 H	161	675P, 675	153	NC-155000-021	159
4P02	145	9P06	150	200 10 H	161	1219	154	NC-155000-027	159
4P03	145	9P07	150	200 12 H	161	1220	154	NC-155000-031	159
4P03ST	146	9P08	150	200 16 H	161	3604	160	NCT-1098	159
4P04	146	9P09	150	200 20 H	161	3606	160	WC100	151
4P05	146	9P10	150	200 24 H	161	20043	162	WC100G	151
4P05R	146	9P11	151	200 28 H	161	20054	162	WC100T	151
4P06	148	9P12	151	200 32 H	161	20065	162	XJ3	157
4P07	147	9P13	150	200 36 H	161	20086	162		
4P08	147	31P0	145	200 40 H	161	20215	162		
4P09	147	31P8	148	200 44 H	161	30022	162		
4P11	148	31POST	145	200 52 H	161	30032	162		
4PVAF	144	33H040 CLAMP	157	200 56 H	161	30043	162		
4T/C	158	33H250 CLAMP	157	200 64 H	161	30044	162		
4T/WOC	158	33S248 CLAMP	157, 158	200 72 H	161	30151	162		
4Y/C	158	41P0	145	200 80 H	161	30215	162		
4Y/WOC	158	41P8	148	200 88 H	161	31512	162		

For Fittings & Clamps Technical Information, Refer to Technical Specification documents at [ndspro.com/specifications](https://ndspro.com/specifications)



## Access Boxes

NDS valve and meter boxes are proudly manufactured in Lindsay, CA and Lithia Springs, GA and span a wide variety of sizes, from 6 in. round to 17 in. x 30 in. rectangular, with multiple color options and designations. Our meter boxes are designed specifically for the Automatic Meter Reading industry. All our boxes are injection molded and contain UV inhibitors for durability, preventing discoloration, cracking, and ensuring long-lasting performance in direct sunlight.



### Product Applications



#### Irrigation

NDS Pro-Spec® and Standard Series valve boxes protect irrigation system components from the elements, foot traffic, lawncare equipment, and potential vandalism, and keep them out of sight.



#### Water Metering

Meter boxes protect water meter components from the elements, foot traffic, lawncare equipment, and potential vandalism, and keep them out of sight.



#### Telecom

Pro-Spec® commercial grade telecom boxes are engineered for heavy-duty use and designed for ease of installation and service for most types of FTTH (fiber to the home) applications. Available with optional marker disc.

We put water in its place™

## Valve Boxes

### Standard Series

Designed for residential and light commercial applications. Injection-molded of structural foam polyolefin.

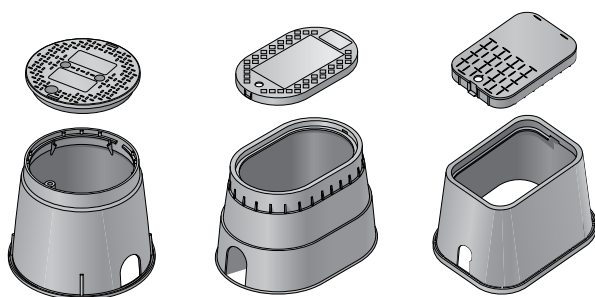

Round

Oval

Rectangle

### NDS Pro-Spec® Series - Commercial Grade

Designed for commercial applications. Injection-molded of high-impact, high-density structural foam polyethylene. Custom lid inserts available for large opportunities.

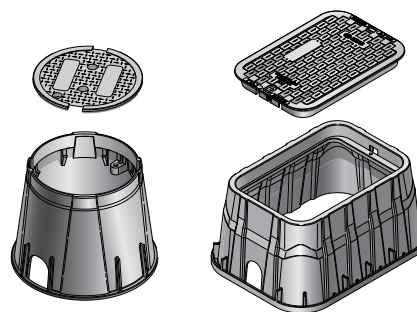

Round

Rectangle

## Meter Boxes

Superior signal transmission versus products made of concrete materials or cast iron. Lighter weight material eases installation and lowers freight and handling costs.

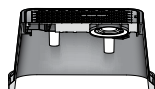

AMR Bottom Mounts

Concealed, protected antennae with exceptional signal, minimal interference, and compatibility with most industry models.

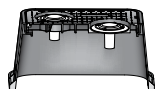

AMR Top Mounts

Recessed design reduces damage risk, eliminates interference, and accommodates most industry antennae, including Touch Read.

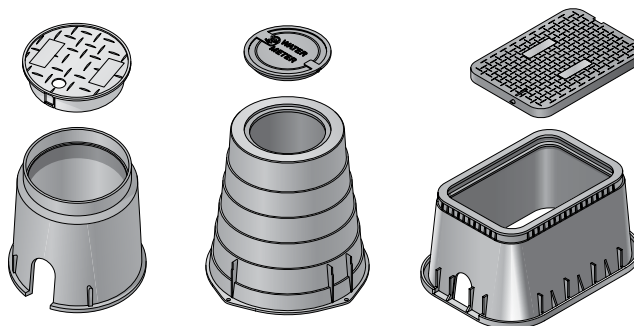

Round

Oval

Rectangle

### Pro-Spec® Telecom Boxes

Also available in Round and Rectangle

## NDS Pro-Spec® Series Valve Boxes – next generation commercial grade

### NDS Pro-Spec® 10 in. Round Corrugated Valve Boxes

**Specifications:** The NDS Pro-Spec® 10 in. round body is tapered and has a minimum wall thickness of 0.250 in. The cover seat area has 8 structural support ribs on the underside of the seat, each with a minimum thickness of 0.250 in. The bottom of the body has a 0.500 in. flange. The 10 in. round cover has the patented Universal Locking Mechanism (ULM) that enables various sizes of bolts/screws to secure cover ranging in sizes from 3/8 to 1/2 in. diameter and minimum 2-1/2 in. length. Nut is no longer needed. A speed or clip nut slot also exists (clip nut not supplied).

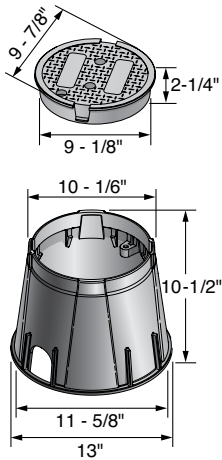

Part No.	Description	Color (Box/Cover)	Pallet Qty.	Weight Ea. (lbs.)	Product Class
<b>Box &amp; Cover</b>					
311BC	10" Round Box, Round Overlapping Cover - ICV	Black/Green	132	4.6	20PR
311BCB	10" Round Box, Round Overlapping Bolt-Down Cover - ICV	Black/Green	132	4.6	20PR
311BCBLK	10" Round Box, Round Overlapping Cover - ICV	Black/Black	132	4.6	20PR
311BCR	10" Round Box, Round Overlapping Cover - Reclaimed Water	Black/Purple	132	4.6	20PR
311BCS	10" Round Box, Round Overlapping Cover - Sewer	Black/Green	132	4.6	20PR
312BC	10" Round Box, Round Overlapping Cover - ICV	Green/Green	132	4.6	20PR
312BC ELEC	10" Round Box, Round Overlapping Cover - Electric	Gray/Gray	132	4.6	20PR
312BCB	10" Round Box, Round Overlapping Bolt-Down Cover - ICV	Green/Green	132	4.4	20PR
312BCB ELEC	10" Round Box, Round Overlapping Bolt-Down Cover - Electric	Gray/Gray	132	4.6	20PR
312BCBS	10" Round Box, Round Overlapping Bolt-Down Cover - Sewer	Green/Green	132	4.6	20PR
312BCRBLK	10" Round Overlapping Reclaimed Cover	Black/Black	132	4.7	20PR
312BCRG	10" Round Box, Round Overlapping Cover - Reclaimed Water	Green/Green	132	4.6	20PR
312BCS	10" Round Box, Round Overlapping Cover - Sewer	Green/Green	132	4.6	20PR
312BCSAND	10" Round Box, Round Overlapping Cover - ICV	Sand/Sand	132	4.4	20PR
312BCW	10" Round Box, Round Overlapping Cover - Water	Green/Green	132	4.6	20PR
312PBCBR	10" Round Box, Round Overlapping Bolt-Down Cover - Reclaimed Water	Purple/Purple	132	4.4	20PR
312PBCR	10" Round Box, Round Overlapping Cover - Reclaimed Water	Purple/Purple	132	4.4	20PR
<b>Cover Only</b>					
311C	10" Round Overlapping Cover - ICV	Green	200	1.5	20PR
311C BLK	10" Round Overlapping Cover - ICV	Black	200	1.5	20PR
311C ELEC	10" Round Overlapping Cover - Electric	Gray	200	1.5	20PR
311CR	10" Round Overlapping Cover - Reclaimed Water	Purple	200	1.4	20PR
311CRG	10" Round Overlapping Cover - Reclaimed Water	Green	200	1.5	20PR
311CS	10" Round Overlapping Cover - Sewer	Green	200	1.5	20PR
311CSAND	10" Round Overlapping Cover - ICV	Sand	200	1.4	20PR
311CW	10" Round Overlapping Cover - Water	Green	200	1.5	20PR
<b>Box Only</b>					
311B	10" Round Box	Black	132	3	20PR
312B	10" Round Box	Green	132	3	20PR
312PB	10" Round Box	Purple	132	3	20PR
113BB	3/8" x 2-1/2" SS Bolt	Steel	n/a	0.1	20NM

## NDS Pro-Spec® 14 in. x 19 in. Rectangular Valve Boxes

**Specifications:** The NDS Pro-Spec® 14 in. x 19 in. body is tapered and has a minimum wall thickness of 0.187 in. The body has a double wall at the top cover seat area with a minimum thickness of 0.200 in. The cover seat area has 18 structural support ribs on the underside of the seat, each with a minimum thickness of 0.200 in. The bottom of the body has a 0.500 in. flange. The 14 in. x 19 in. cover has an average thickness of 0.200 in. The valve box has the patented Universal Locking Mechanism (ULM) that enables various sizes of bolts/screws to secure cover ranging in sizes from 3/8 to 1/2 in. diameter and minimum 2-1/2 in. length. Nut is no longer needed. A speed or clip nut slot also exists (clip nut not supplied).

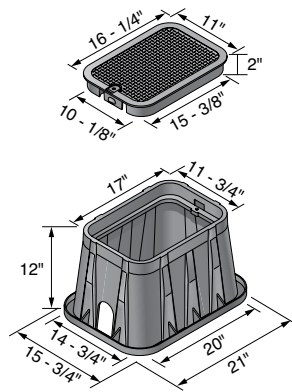

Part No.	Description	Color (Box/Cover)	Pallet Qty.	Weight Ea. (lbs.)	Product Class
<b>Box &amp; Cover</b>					
313BC	14" x 19" Box, Overlapping Cover - ICV	Black/Green	72	8.4	20PR
313BCB	14" x 19" Box, Overlapping Bolt-Down Cover - ICV	Black/Green	72	8.5	20PR
313BCBBLK	14" x 19" Box, Overlapping Bolt-Down Cover - ICV	Black/Black	72	8.5	20PR
313BCBR	14" x 19" Box, Overlapping Bolt-Down Cover - Reclaimed Water	Black/Purple	72	8.5	20PR
313BCBRBLK	14" x 19" Box, Overlapping Bolt-Down Cover - Reclaimed Water	Black/Black	72	8.5	20PR
313BCBWBLK	14" x 19" Box, Overlapping Bolt-Down Cover - Water	Black/Black	72	8.5	20PR
314BC	14" x 19" Box, Overlapping Cover - ICV	Green/Green	72	8.5	20PR
314BCB	14" x 19" Box, Overlapping Bolt-Down Cover - ICV	Green/Green	72	8.5	20PR
314BCB ELEC	14" x 19" Box, Overlapping Bolt-Down Cover - Electric	Gray/Gray	72	8.5	20PR
314BCBRG	14" x 19" Box, Overlapping Bolt-Down Cover - Reclaimed Water	Green/Green	72	8.5	20PR
314BCBS	14" x 19" Box, Overlapping Bolt-Down Cover - Sewer	Green/Green	72	8.5	20PR
314BCBSAND	14" x 19" Box, Overlapping Bolt-Down Cover - ICV	Sand/Sand	72	8.5	20PR
314BCBW	14" x 19" Box, Overlapping Bolt-Down Cover - Water	Green/Green	72	8.5	20PR
314BCSAND	14" x 19" Box, Overlapping Cover - ICV	Sand/Sand	72	8.2	20PR
314PBCBR	14" x 19" Box, Overlapping Bolt-Down Cover - Reclaimed Water	Purple/Purple	72	8.4	20PR
314PBCR	14" x 19" Box, Overlapping Cover - Reclaimed Water	Purple/Purple	72	7.3	20PR
<b>Cover Only</b>					
313C	14" x 19" Overlapping Cover - ICV	Green	300	2.3	20PR
313C ELEC	14" x 19" Overlapping Cover - Electric	Gray	300	2.3	20PR
313CBLK	14" x 19" Overlapping Cover - ICV	Black	300	2.3	20PR
313CG ELEC	14" x 19" Overlapping Cover - Electric	Green	300	2.3	20PR
313CR	14" x 19" Overlapping Cover - Reclaimed Water	Purple	300	2.3	20PR
313CRBLK	14" x 19" Overlapping Cover - Reclaimed Water	Black	300	2.81	20PR
313CRG	14" x 19" Overlapping Cover - Reclaimed Water	Green	300	2.3	20PR
313CSAND	14" x 19" Overlapping Cover - ICV	Sand	300	2.3	20PR
313CW	14" x 19" Overlapping Cover - Water	Black	300	2.3	20PR
314CS	14" x 19" Overlapping Cover - Sewer	Green	300	2.3	20PR
314CW	14" x 19" Overlapping Cover - Water	Green	300	2.3	20PR
<b>Box Only</b>					
314B	14" x 19" Box	Green	72	5	20PR
314BBLK	14" x 19" Valve Box	Black	72	5.41	20PR
113BB	3/8" x 2-1/2" SS Bolt	Steel	n/a	0.1	20NM

## NDS Pro-Spec® 13 in. x 20 in. Rectangular Valve Boxes

**Specifications:** The NDS Pro-Spec® 13 in. x 20 in. body is tapered and has a minimum wall thickness of 0.250 in. The body has a double wall at the top cover seat area with a minimum thickness of 0.250 in. The cover seat area has 22 structural support ribs on the underside of the seat, each with a minimum thickness of 0.13 in. The bottom of the body has a 0.500 in. flange. The 13 in. x 20 in. cover has an average thickness of 0.250 in. The valve box has a 3/8 in. brass nut for the bolt-down as a standard feature.

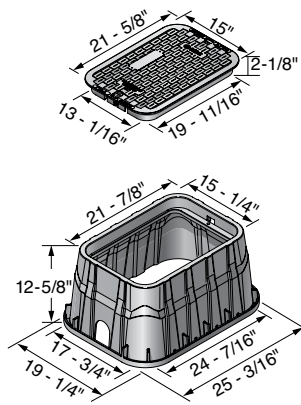

Part No.	Description	Color (Box/Cover)	Pallet Qty.	Weight Ea. (lbs.)	Product Class
<b>Box &amp; Cover</b>					
317BCB	13" x 20" Jumbo Box, Overlapping Bolt-Down Cover - ICV	Black/Green	56	14.6	20PR
317BCBBLK	13" x 20" Jumbo Box, Overlapping Bolt-Down Cover - ICV	Black/Black	56	14.6	20PR
317BCBW	13" x 20" Jumbo Box, Overlapping Bolt-Down Cover - Water	Black/Black	56	14.6	20PR
318BC	13" x 20" Jumbo Box, Overlapping Cover - ICV	Green/Green	56	14.6	20PR
318BCB	13" x 20" Jumbo Box, Overlapping Bolt-Down Cover - ICV	Green/Green	56	14.6	20PR
318BCBRBLK	13" x 20" Jumbo Box, Overlapping Bolt-Down Cover - Reclaimed Water	Black/Black	56	14.6	20PR
318BCBRG	13" x 20" Jumbo Box, Overlapping Bolt-Down Cover - Reclaimed Water	Green/Green	56	14.6	20PR
318BCBS	13" x 20" Jumbo Box, Overlapping Bolt-Down Cover - Sewer	Green/Green	56	14.6	20PR
318BCBSAND	13" x 20" Jumbo Box, Overlapping Bolt-Down Cover - ICV	Sand/Sand	56	14.6	20PR
318PBCBR	13" x 20" Jumbo Box, Overlapping Bolt-Down Cover - Reclaimed Water	Purple/Purple	56	10.7	20PR
318PBCR	13" x 20" Jumbo Box, Overlapping Cover - Reclaimed Water	Purple/Purple	56	14.6	20PR
<b>Cover Only</b>					
317C	13" x 20" Overlapping Cover - ICV	Green	180	5.1	20PR
317C BLK	13" x 20" Overlapping Cover - ICV	Black	180	5.1	20PR
317CR	13" x 20" Overlapping Cover - Reclaimed Water	Purple	180	5	20PR
317CS	13" x 20" Overlapping Cover - Sewer	Green	180	5.1	20PR
317CSAND	13" x 20" Overlapping Cover - ICV	Sand	180	5	20PR
317CW	13" x 20" Overlapping Cover - Water	Black	180	5.1	20PR
318CW	13" x 20" Overlapping Cover - Water	Green	180	5.1	20PR
<b>Box Only</b>					
318B	13" x 20" Jumbo Box	Green	56	9.2	20PR
318B BLK	13" x 20" Jumbo Box	Black	56	9.2	20PR
318PB	13" x 20" Jumbo Box	Purple	56	9.55	20PR
113BB	3/8" x 2-1/2" SS Bolt	Steel	n/a	0.1	20NM



We put water in its place™

## NDS Pro-Spec® 13 in. x 24 in. Rectangular Valve Boxes

**Specifications:** The NDS Pro-Spec® 13 in. x 24 in. body is tapered and has a minimum wall thickness of 0.270 in. The body has a double wall at the top cover seat area with a minimum thickness of 0.270 in. The cover seat area has 18 structural support ribs on the underside of the seat, each with a minimum thickness of 0.250 in. The bottom of the body has a 1.0 in. flange. The 13 in. x 24 in. cover has an average thickness of 0.320 in. The valve box has a 3/8 in. brass nut for the bolt-down as a standard feature.

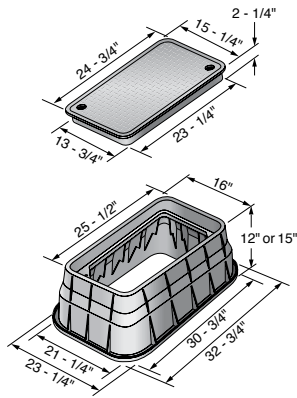

Part No.	Description	Color (Box/Cover)	Pallet Qty.	Weight Ea. (lbs.)	Product Class
<b>Box &amp; Cover</b>					
321BCB	13" x 24" x 12" Box, Overlapping Bolt-Down Cover - ICV	Green/Green	12	24	20PR
321BCBS	13" x 24" x 12" Box, Overlapping Bolt-Down Cover - Sewer	Green/Green	12	24	20PR
321BCBW	13" x 24" x 12" Box, Overlapping Bolt-Down Cover - Water	Green/Green	12	24	20PR
322BCB	13" x 24" x 15" Box, Overlapping Bolt-Down Cover - ICV	Green/Green	12	24	20PR
322PBCBR	13" x 24" x 12" Box, Overlapping Bolt-Down Cover - Reclaimed Water	Purple/Purple	12	24	20PR
325BCB	13" x 24" x 15" Box, Overlapping Bolt-Down Cover - ICV	Black/Green	12	24	20PR
<b>Cover Only</b>					
322C	13" x 24" Overlapping Cover - ICV	Green	125	7	20PR
322CS	13" x 24" Overlapping Cover - Sewer	Green	125	7	20PR
<b>Box Only</b>					
321B	13" x 24" x 12" Box	Green	12	19	20PR
322B	13" x 24" x 15" Box	Green	12	19	20PR
325B	13" x 24" x 15" Box	Black	12	19	20PR
121BB	3/8" x 3" SS Bolt	Steel	n/a	0.1	20NM

## NDS Pro-Spec® 17 in. x 30 in. Rectangular Valve Boxes

**Specifications:** The NDS Pro-Spec® 17 in. x 30 in. body is tapered and has a minimum wall thickness of 0.320 in. The body has a double wall at the top cover seat area with a minimum thickness of 0.320 in. The cover seat area has 20 structural support ribs on the underside of the seat, each with a minimum thickness of 0.250 in. The bottom of the body has a 1.000 in. flange. The 17 in. x 30 in. cover has an average thickness of 0.350 in. The valve box has a 3/8 in. brass nut for the bolt-down as a standard feature.

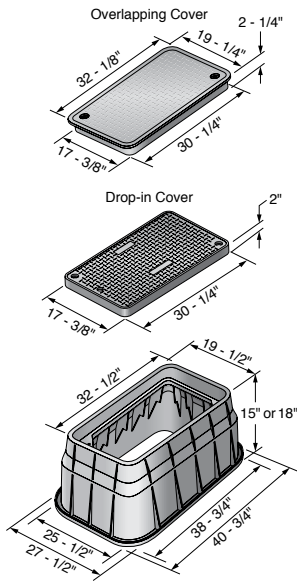

Part No.	Description	Color (Box/Cover)	Pallet Qty.	Weight Ea. (lbs.)	Product Class
<b>Box &amp; Cover</b>					
324BCB	17" x 30" x 15" Box, Overlapping Bolt-Down Cover - ICV	Green/Green	6	28	20PR
324BCB-BG	17" x 30" x 15" Box, Overlapping Bolt-Down Cover - ICV	Black/Green	6	28	20PR
324BCBS	17" x 30" x 15" Box, Overlapping Bolt-Down Cover - Sewer	Green/Green	6	28	20PR
324BCDB	17" x 30" x 15" Box, Drop-in Bolt-Down Cover - ICV	Green/Green	6	28	20PR
326BCB	17" x 30" x 18" Box, Overlapping Bolt-Down Cover - ICV	Green/Green	6	39	20PR
326BCB-BG	17" x 30" x 18" Box, Overlapping Bolt-Down Cover - ICV	Black/Green	6	41	20PR
326BCDB	17" x 30" x 18" Box, Drop-in Bolt-Down Cover - ICV	Green/Green	6	37	20PR
326BCDB ELEC	17" x 30" x 18" Box, Drop-in Cover - Electric	Gray/Gray	6	37	20PR
326BCDB-BG	17" x 30" x 18" Box, Drop-in Bolt-Down Cover - ICV	Black/Green	6	37	20ND
326BCDBW	17" x 30" x 18" Box, Drop-in Bolt-Down Cover - Water	Black/Black	6	37	20ND
326PBCBR	17" x 30" x 18" Box, Overlapping Cover - Reclaimed Water	Purple/Purple	6	38	20PR
<b>Cover Only</b>					
323C	17" x 30" Overlapping Cover - ICV	Green	75	11	20PR
323CD	17" x 30" Drop-in Cover - ICV	Green	75	11	20PR
323CD ELEC	17" x 30" Drop-in Cover - Electric	Gray	75	11	20PR
323CDW	17" x 30" Drop-in Cover - Water	Black	75	11	20PR
323CR	17" x 30" Overlapping Cover - Reclaimed Water	Purple	75	11	20PR
323CS	17" x 30" Overlapping Cover - Sewer	Green	75	11	20PR
<b>Box Only</b>					
324B	17" x 30" x 15" Box	Green	6	20	20PR
324B BLK	17" x 30" x 15" Box	Black	6	20	20PR
326B	17" x 30" x 18" Box	Green	10	23	20PR
326B BLK	17" x 30" x 18" Box	Black	10	23	20PR

## Standard Series Valve Boxes

### Standard Series 6 in. Round Valve Boxes

**Specifications:** The NDS Standard Series 6 in. round body is tapered and has a minimum wall thickness of 0.200 in. The body has a double wall at the top cover seat area with a minimum thickness of 0.130 in. The bottom of the body has a 0.250 in. flange. The 6 in. round cover has an average thickness of 0.187 in.

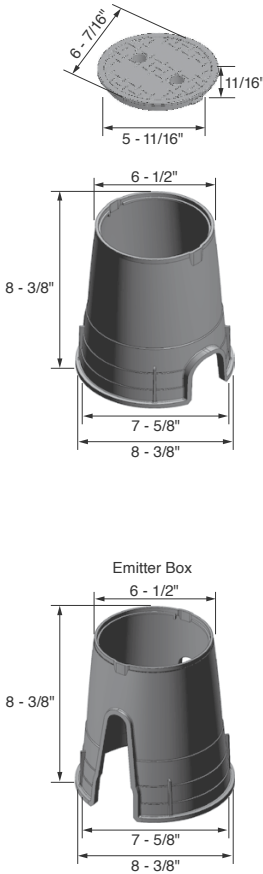

Part No.	Description	Color (Box/Cover)	Pallet Qty.	Weight Ea. (lbs.)	Product Class
<b>Box &amp; Cover</b>					
107BC	6" Round Box, Round Overlapping Cover - ICV	Black/Green	250	1.5	20ND
107BC BLK	6" Round Box, Round Overlapping Cover - ICV	Black/Black	250	1.5	20ND
107BC SAND	6" Round Box, Round Overlapping Cover - ICV	Sand/Sand	250	1.5	20ND
107BC SLV	6" Round Box, Round Overlapping Cover - ICV - 20 per sleeve	Black/Green	400	1.5	20ND
107BCH	6" Round Snap-in Valve Box, Round Snap-in Overlapping Cover - ICV	Black/Green	250	1.5	20ND
107BCR	6" Round Box, Round Overlapping Cover - Reclaimed Water	Black/Purple	250	1.5	20ND
107BCR BLK	6" Round Box, Round Overlapping Cover - Reclaimed Water	Black/Black	250	1.5	20ND
107BCS	6" Round Box, Round Overlapping Cover - Sewer	Black/Green	250	1.5	20NM
107BCW	6" Round Box, Round Overlapping Solid Plastic Cover - Water	Black/Green	250	1.5	20NM
107EBC	6" Round Emitter Box, Round Overlapping Cover - Emitter Box	Black/Green	250	1.5	20ND
107PBCR	6" Round Box, Round Overlapping Cover - Reclaimed Water	Purple/Purple	250	1.5	20ND
108BC	6" Round Box, Round Overlapping Cover - ICV	Green/Green	250	1.5	20ND
108BCS	6" Round Box, Round Overlapping Cover - Sewer	Green/Green	250	1.5	20ND
108BCW	6" Round Box, Round Overlapping Cover - Water	Green/Green	250	1.5	20ND
<b>Cover Only</b>					
107C	6" Round Overlapping Cover - ICV	Green	800	0.36	20ND
107C BLK	6" Round Cover ICV	Black	250	1.5	20ND
107C BRN	6" Round Cover ICV	Brown	250	1.5	20ND
107C SAND	6" Round Overlapping Cover - ICV	Sand	800	0.4	20ND
107CH	6" Round Snap-in Overlapping Cover - ICV	Green	1200	0.35	20ND
107CR	6" Round Overlapping Cover - Reclaimed Water	Purple	800	0.4	20ND
107CS	6" Round Overlapping Cover - Sewer	Green	800	0.4	20NM
107CW	6" Round Overlapping Cover - Water	Green	800	0.4	20NM
<b>Box Only</b>					
106B	6" Round Snap-in Valve Box	Black	250	0.9	20ND
107B	6" Round Box	Black	250	1.23	20ND
108B	6" Round Box	Green	250	1.23	20ND

## Standard Series 10 in. Round Valve Boxes

**Specifications:** The NDS Standard Series 10 in. round body is tapered and has a minimum wall thickness of 0.200 in. The cover seat area has 6 structural support ribs on the underside of the seat, each with a minimum thickness of 0.250 in. The bottom of the body has a 0.500 in. flange. The 10 in. round cover has an average thickness of 0.250 in. The valve box has the patented Universal Locking Mechanism (ULM) that enables various sizes of bolts/screws to secure cover ranging in sizes from 5/16 in. to 3/8 in. diameter and minimum 1-1/2 in. length. Nut is no longer needed. A speed or clip nut slot also exists (clip nut not supplied).

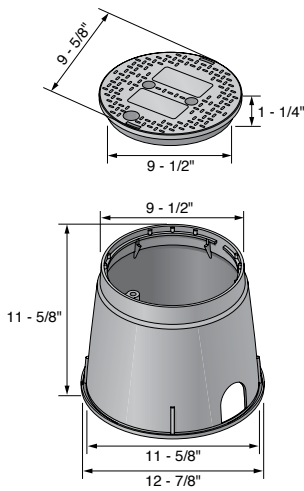

Part No.	Description	Color (Box/Cover)	Pallet Qty.	Weight Ea. (lbs.)	Product Class
<b>Box &amp; Cover</b>					
111BC	10" Round Box, Round Overlapping Cover - ICV	Black/Green	180	3	20ND
111BC BLK	10" Round Box, Round Overlapping Cover - ICV	Black/Black	180	3	20ND
111BC CTN	10" Round Box, Round Overlapping Cover - ICV - 4 per carton	Black/Green	72	3.9	20ND
111BC SAND	10" Round Box, Round Overlapping Cover - ICV	Sand/Sand	180	3.2	20ND
111BCB	10" Round Box, Round Overlapping Bolt-Down Cover - ICV	Black/Green	180	3	20ND
111BCBW	10" Round Box, Round Overlapping Bolt-Down Cover - Water	Black/Black	180	3	20NM
111BCR	10" Round Box, Round Overlapping Cover - Reclaimed Water	Black/Purple	180	3	20ND
111BCR BLK	10" Round Box, Round Overlapping Cover - Reclaimed Water	Black/Black	180	3	20ND
111BCS	10" Round Box, Round Overlapping Cover - Sewer	Black/Green	180	3	20NM
111BCW	10" Round Box, Round Overlapping Cover - Water	Black/Green	180	3	20NM
111PBCR	10" Round Box, Round Overlapping Cover - Reclaimed Water	Purple/Purple	180	3	20ND
112BC	10" Round Box, Round Overlapping Cover - ICV	Green/Green	180	3	20ND
112BCB	10" Round Box, Round Overlapping Bolt-Down Cover - ICV	Green/Green	180	3	20ND
112BCRG	10" Round Box, Round Overlapping Cover - Reclaimed Water	Green/Green	180	3	20ND
112BCS	10" Round Box, Round Overlapping Cover - Sewer	Green/Green	180	3.9	20NM
<b>Cover Only</b>					
111C	10" Round Overlapping Cover - ICV	Green	300	0.95	20ND
111C BLK	10" Round Overlapping Cover - ICV	Black	300	0.95	20ND
111C BRN	10" Round Overlapping Cover - ICV	Brown	300	0.95	20ND
111C SAND	10" Round Overlapping Cover - ICV	Sand	300	0.95	20ND
111CR	10" Round Overlapping Cover - Reclaimed Water	Purple	300	1	20ND
111CS	10" Round Overlapping Cover - Sewer	Green	300	1	20NM
111CW BLK	10" Round Overlapping Cover - Water	Black	300	0.95	20ND
111CW	10" Round Overlapping Cover - Water	Green	300	1	20NM
<b>Box Only</b>					
111B	10" Round Box	Black	180	2	20NM
112B	10" Round Box	Green	300	2	20ND
111BB	5/16" x 1-3/4" SS Bolt	Steel	n/a	0.05	20ND

## Standard Series 14 in. x 19 in. Rectangular Valve Boxes

**Specifications:** The NDS Standard Series 14 in. x 19 in. body is tapered and has a minimum wall thickness of 0.200 in. The body has a double wall at the top cover seat area with a minimum thickness of 0.250 in. The cover seat area has 16 structural support ribs on the underside of the seat, each with a minimum thickness of 0.250 in. The bottom of the body has a 0.500 in. flange. The 14 in. x 19 in. cover has an average thickness of 0.250 in. The valve box has the patented Universal Locking Mechanism (ULM) that enables various sizes of bolts/screws to secure cover ranging in sizes from 3/8 to 1/2 in. diameter and minimum 2-1/2 in. length. Nut is no longer needed. A speed or clip nut slot also exists (clip nut not supplied). The 6 in. straight wall extensions have a 3/8 in. brass nut for bolt-down as a standard feature.

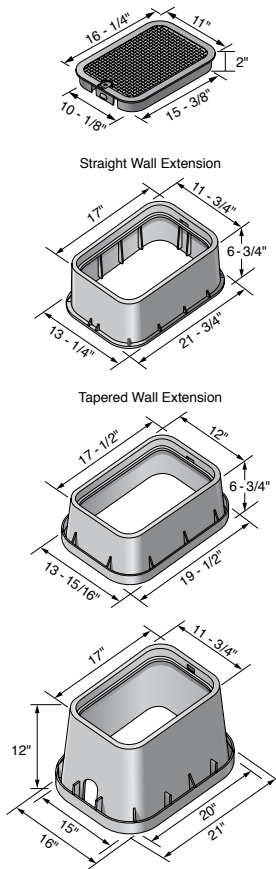

Part No.	Description	Color (Box/Cover)	Pallet Qty.	Weight Ea. (lbs.)	Product Class
<b>Box &amp; Cover</b>					
115	14" x 19" x 6" Straight Wall Extension, Overlapping Cover - ICV	Black/Green	49	16.16	20ND
116	14" x 19" x 6" Straight Wall Extension, Overlapping Cover - ICV	Green/Green	49	6.16	20ND
113BC	14" x 19" Box, Overlapping Cover - ICV	Black/Green	78	9.1	20ND
113BC SAND	14" x 19" Box, Overlapping Cover - ICV	Sand/Sand	78	9.25	20ND
113BCBLK	14" x 19" Box, Overlapping Cover - ICV	Black/Black	78	9.1	20ND
113BCD	14" x 19" Box, Drop-in Cover - ICV	Black/Green	78	8	20ND
113BCE	14" x 19" Box, Overlapping Cover - Electrical	Black/Green	78	9.32	20NM
113BCR	14" x 19" Box, Overlapping Cover - Reclaimed Water	Black/Purple	78	9.1	20ND
113BCRBLK	14" x 19" Box, Overlapping Cover - Reclaimed Water	Black/Black	78	9.1	20ND
113BCS	14" x 19" Box, Overlapping Cover - Sewer	Black/Green	78	9.1	20ND
113BCW	14" x 19" Box, Overlapping Cover - Water	Black/Black	78	9.32	20NM
113BCWG	14" x 19" Box, Overlapping Cover - Water	Black/Green	78	9.1	20ND
113PBCR	14" x 19" Box, Overlapping Cover - Reclaimed Water	Purple/Purple	78	9.29	20ND
114BC	14" x 19" Box, Overlapping Cover - ICV	Green/Green	78	9.95	20ND
114BCS	14" x 19" Box, Overlapping Cover - Sewer	Green/Green	78	9.95	20NM
114BCW	14" x 19" Box, Overlapping Cover - Water	Green/Green	78	9.95	20NM
115BCR	14" x 19" x 6" Box, Overlapping Cover - ICV	Black/Purple	42	7.29	20ND
115TBC	14" x 19" x 6" Tapered Box, Overlapping Cover - ICV	Black/Green	96	6	20ND
115TBCR	14" x 19" x 6" Tapered Box, Overlapping Cover - Reclaimed Water	Black/Purple	96	5.7	20ND
116-SAND	14" x 19" x 6" Straight Wall Extension, Overlapping Cover - ICV	Sand/Sand	49	6	20ND
116TBC	14" x 19" x 6" Tapered Box, Overlapping Cover - ICV	Green/Green	96	5.55	20ND
116TBC SAND	14" x 19" x 6" Tapered Box, Overlapping Cover - ICV	Sand/Sand	96	6.16	20ND
<b>Cover Only</b>					
113C	14" x 19" Overlapping Cover - ICV	Green	300	2	20ND
113C BRN	14" x 19" Overlapping Cover - ICV	Brown	300	2	20ND
113C SAND	14" x 19" Overlapping Cover - ICV	Sand	300	2	20ND
113CB	14" x 19" Overlapping Cover - ICV	Black	300	2	20ND
113CE	14" x 19" Overlapping Cover - Electrical	Green	300	2.3	20NM
113CR	14" x 19" Overlapping Cover - Reclaimed Water	Purple	300	2.5	20ND
113CRG	14" x 19" Overlapping Cover - Reclaimed Water	Green	300	2	20ND
113CS	14" x 19" Overlapping Cover - Sewer	Green	300	2	20ND
113CW	14" x 19" Overlapping Cover - Water	Black	300	2	20ND
114CW	14" x 19" Overlapping Cover - Water	Green	300	2	20ND
<b>Box Only</b>					
113-6	14" x 19" x 6" Straight Wall Extension	Black	49	4.1	20ND
113B	14" x 19" Box	Black	78	6.03	20NM
114-6	14" x 19" x 6" Straight Wall Extension	Green	49	3.86	20ND
114B	14" x 19" Box	Green	78	6.1	20ND
113BB	3/8" x 2-1/2" SS Bolt	Steel	n/a	0.1	20NM

## Standard Series 13 in. x 20 in. Rectangular Valve Boxes

**Specifications:** The NDS Standard Series 13 in. x 20 in. body is tapered and has a minimum wall thickness of 0.250 in. The body has a double wall at the top cover seat area with a minimum thickness of 0.250 in. The cover seat area has 16 structural support ribs on the underside of the seat, each with a minimum thickness of 0.250 in. The bottom of the body has a 0.500 in. flange. The 13 in. x 20 in. cover has an average thickness of 0.250 in. The valve box has a 3/8 in. brass nut for the bolt-down as a standard feature.

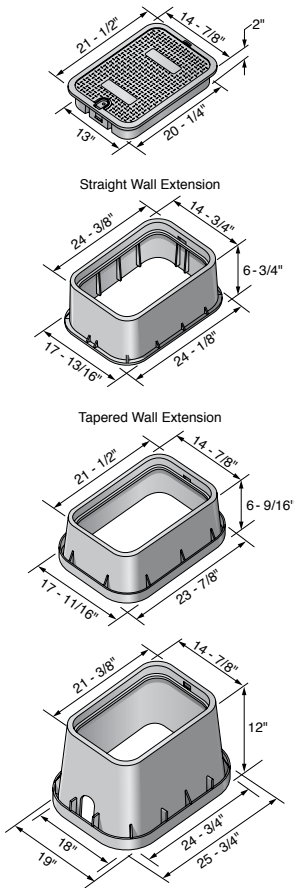

Part No.	Description	Color (Box/Cover)	Pallet Qty.	Weight Ea. (lbs.)	Product Class
<b>Box &amp; Cover</b>					
119	13" x 20" x 6" Jumbo Straight Wall Extension, Overlapping Cover - ICV	Black/Green	32	12	20ND
120	13" x 20" x 6" Jumbo Straight Wall Extension, Overlapping Cover - ICV	Green/Green	32	12	20ND
117BC	13" x 20" Jumbo Box, Overlapping Cover - ICV	Black/Green	56	14	20ND
117BC BLK	13" x 20" Jumbo Box, Overlapping Cover - ICV	Black/Black	56	14	20ND
117BC SAND	13" x 20" Jumbo Box, Overlapping Cover - ICV	Sand/Sand	56	14	20ND
117BCD	13" x 20" Jumbo Box, Drop-in Cover - ICV	Black/Green	56	14	20ND
117BCR	13" x 20" Jumbo Box, Overlapping Cover - Reclaimed Water	Black/Purple	56	14	20ND
117BCS	13" x 20" Jumbo Box, Overlapping Cover - Sewer	Black/Green	56	14	20NM
117BCW	13" x 20" Jumbo Box, Overlapping Cover - Water	Black/Black	56	14	20ND
117PBCR	13" x 20" Jumbo Box, Overlapping Cover - Reclaimed Water	Purple/Purple	56	14	20ND
118BC	13" x 20" Jumbo Box, Overlapping Cover - ICV	Green/Green	56	14	20ND
118BCS	13" x 20" Jumbo Box, Overlapping Cover - Sewer	Green/Green	56	14	20ND
119 SAND	13" x 20" x 6" Jumbo Straight Wall Extension, Overlapping Cover - ICV	Sand/Sand	32	10.95	20ND
119TBC	13" x 20" x 6" Tapered Box, Overlapping Cover - ICV	Black/Green	56	11.15	20ND
119TBCR	13" x 20" x 6" Tapered Box, Overlapping Cover - Reclaimed Water	Black/Purple	56	11.15	20ND
<b>Cover Only</b>					
117C	13" x 20" Overlapping Cover - ICV	Green	180	5.3	20ND
117C BRN	13" x 20" Overlapping Cover - ICV	Brown	180	5.3	20ND
117C SAND	13" x 20" Overlapping Cover - ICV	Sand	180	5	20ND
117CB	13" x 20" Overlapping Cover - ICV	Black	180	5.3	20ND
117CR	13" x 20" Overlapping Cover - Reclaimed Water	Purple	180	5.3	20ND
117CS	13" x 20" Jumbo Overlapping Cover - Sewer	Green	180	5	20NM
117CW	13" x 20" Overlapping Cover - Water	Black	180	5.3	20ND
<b>Box Only</b>					
117-6	13" x 20" x 6" Jumbo Straight Wall Extension	Black	32	6.88	20ND
117B	13" x 20" Jumbo Box	Black	56	9.65	20NM
118-6	13" x 20" x 6" Jumbo Straight Wall Extension	Green	32	6.88	20ND
113BB	3/8" x 2-1/2" SS Bolt	Steel	n/a	0.1	20NM

### 6 in. Round Valve Boxes

**Specifications:** NDS 6 in. round body is tapered and has a minimum wall thickness of 0.130 in. The body has a double wall at the top cover seat area with a minimum thickness of 0.125 in. The bottom of the body has a 0.250 in. flange. The 6 in. round cover has an average thickness of 0.150 in.

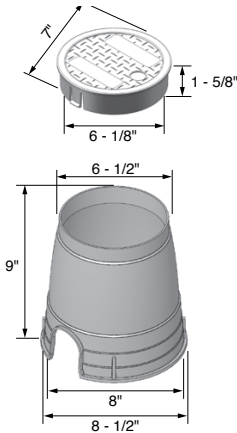

Part No.	Description	Color (Box/Cover)	Pallet Qty.	Weight Ea. (lbs.)	Product Class
<b>Box &amp; Cover</b>					
D108-G	6" Valve Box and Overlapping Cover - ICV	Green/Green	600	1.2	20ND
D109-G	6" Round Box, 6" Round Cover - ICV	Black/Green	600	1.2	20ND
D109-P	6" Round Box, 6" Round Cover - Reclaimed Water	Black/Purple	600	1.21	20ND
D109-GBOX	6" Round Box, 6" Round Cover - ICV	Black/Green	36 Box/ 900 Pal.	1.2	20ND
<b>Cover Only</b>					
D109-GL	6" Round Cover - ICV	Green	600	0.4	20ND
D109-PL	6" Round Cover - Reclaimed Water	Purple	600	0.4	20ND

### NDS SureFit™ Round Universal Lids

If you've ever had to find a replacement lid for a round valve box, you know it's not easy. Different brands design their boxes with different dimensions, so a lid that works for one brand may not fit another. NDS SureFit™ Universal Lids are engineered to fit valve round boxes from a variety of manufacturers. Now it is easier to replace broken, missing, or misshapen lids with a proper fit. The SureFit™ Universal Lid is available in two sizes: one size fits 6 in. and 7 in. round valve boxes and the other size fits 10 in. round valve boxes.

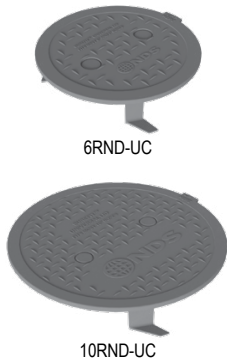

Part No.	Description	Color	Order Qty.	Weight Ea. (lbs.)	Product Class
6RND-UC	Universal Fit for 6" and 7" Round	Green	16	.4	20ND
10RND-UC	Universal Fit for 10" Round	Green	14	.9	20ND

## 8 in. x 12 in. Oval Valve Boxes

**Specifications:** NDS 8 in. x 12 in. body is tapered and has a minimum wall thickness of 0.187 in. The body has a double wall at the top cover seat area with a minimum thickness of 0.200 in. The cover seat area has 10 structural support ribs on the underside of the seat, each with a minimum thickness of 0.150 in. The bottom of the body has a 0.375 in. flange. The 8 in. x 12 in. cover shall have an average thickness of 0.150 in.

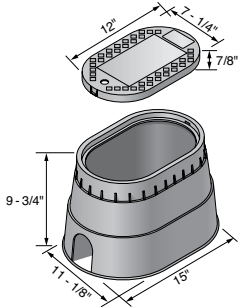

Part No.	Description	Color (Box/Cover)	Pallet Qty.	Weight Ea. (lbs.)	Product Class
<b>Box &amp; Cover</b>					
M2-SG	8" x 12" Box, Drop-in Cover - Control Valve	Black/Green	132	4	20ND
<b>Cover Only</b>					
M2-SG-LID	8" x 12", Drop-in Cover	Green	132	0.719	20ND

## 8 in. x 14 in. Oval Valve Boxes

**Specifications:** NDS 8 in. x 14 in. body is tapered and has a minimum wall thickness of 0.187 in. The body has a double wall at the top cover seat area with a minimum thickness of 0.200 in. The cover seat area has 10 structural support ribs on the underside of the seat, each with a minimum thickness of 0.150 in. The bottom of the body has a 0.375 in. flange. The 8 in. x 14 in. cover has an average thickness of 0.150 in.

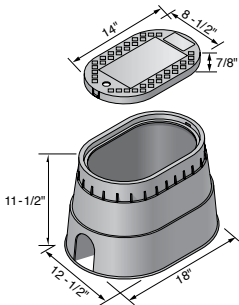

Part No.	Description	Color (Box/Cover)	Pallet Qty.	Weight Ea. (lbs.)	Product Class
<b>Box &amp; Cover</b>					
M4-SG	8" x 14" Box, Drop-in Cover - Control Valve	Black/Green	96	4.6	20ND



We put water in its place™

## 10 in. x 15 in. Rectangular Valve Boxes

**Specifications:** NDS 10 in. x 15 in. x 10 in. body is tapered and has a minimum wall thickness of 0.130 in. The body has a double wall at the top cover seat area with a minimum thickness of 0.200 in. The cover seat area has 12 structural support ribs on the underside of the seat, each with a minimum thickness of 0.130 in. The bottom of the body has a 0.750 in. flange. The D1000 cover has an average thickness of 0.187 in. NDS D1000 valve boxes and covers are injection molded of structural foam recycled polyolefin material with a melt index between 10-12. Coloring and UV stabilizers are added, along with processing lubricants when needed.

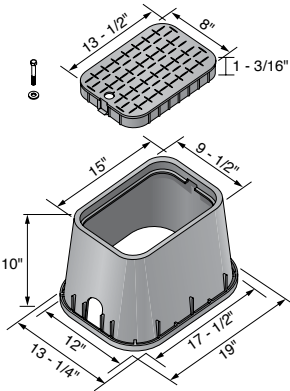

Part No.	Description	Color (Box/Cover)	Pallet Qty.	Weight Ea. (lbs.)	Product Class
<b>Box &amp; Cover</b>					
D1000-SG	10" x 15" x 10" Box, Drop-in Cover -ICV	Black/Green	96	4.8	20ND
<b>Cover Only</b>					
D1000-SGL	10" x 15" Drop-in Cover - ICV	Green	360	1.4	20ND
<b>Box Only</b>					
D1000-B/O	10" x 15" x 10" Box	Black	96	3.4	20ME

## Automatic Meter Reader (AMR) Boxes

### 14 in. x 19 in. AMR Meter Boxes & Covers, standard commercial grade

**Specifications:** NDS 14 in. x 19 in. x 12 in. body is tapered and has a minimum wall thickness of 0.250 in. The body has a double wall at the top cover seat area with a minimum thickness of 0.187 in. The cover seat area has 30 structural support ribs on the underside of the seat, each with a minimum thickness of 3/16 in. The bottom of the body has a 1 in. flange. The 14 in. x 19 in. cover has a minimum thickness of 0.250 in.

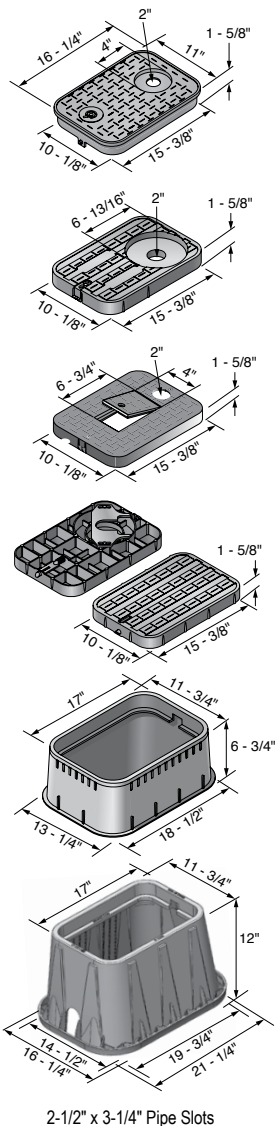

Part No.	Description - Marking	Color (Box/Cover)	Pallet Qty.	Weight Ea. (lbs.)	Product Class
<b>Drop-in Box &amp; Cover</b>					
D12-BAMR	14" x 19" x 12" Box, Drop-in Locking Solid Plastic, Single Bottom Mount AMR Bracket Cover - Water Meter	Black/Black	72	8.90	20ME
D12-TAMR	14" x 19" x 12" Box, Drop-in Locking Solid Plastic, Single 2" AMR/TR Hole w/ 7" Top Recess Cover - Water Meter	Black/Black	72	9.22	20ME
D1200-DITR	14" x 19" x 12" Box, Drop-in Solid Plastic, Single 2" AMR/TR Hole Cover - Water Meter	Black/Black	72	9.00	20ME
<b>Drop-in Cover Only</b>					
D12-BAMRL	14" x 19" Drop-in Locking Solid Plastic, Single Bottom Mount AMR Bracket Cover - Water Meter	Black	100	2.10	20ME
D12-TAMRL	14" x 19" Drop-in Locking Solid Plastic, Single 2" AMR/TR Hole w/ 7" Top Recess Cover - Water Meter	Black	100	2.42	20ME
D1200-DITRL	14" x 19" Drop-in Solid Plastic, Single 2" AMR/TR Hole Cover - Water Meter	Black	100	2.20	20ME
<b>Overlapping Cover Only</b>					
D12AMR-OLLOCL	14" x 19" Overlapping Locking Solid Plastic, Single 4" Top Recess Cover - Water Meter	Black	100	2.80	20ME
D12AMR-OLLOCTRL	14" x 19" Overlapping Locking Solid Plastic, Single 2" AMR/TR Hole w/ 4" Top Recess Cover - Water Meter	Black	100	2.80	20ME
D12AMR-OLLOCTRBLUL	14" x 19" Blue Overlapping Locking Solid Plastic, Single 2" AMR/TR Hole w/ 4" Top Recess Cover - Water Meter	Blue	100	2.80	20ME
<b>Box Only</b>					
D1200-B/O	14" x 19" x 12" Box	Black	72	6.80	20ME
D600E-EXT	14" x 19" x 6" Extension	Black	42	4.20	20ME
D1800-B/O	14" x 19" x 18" Box	Black	48	10.00	20ME

## 13 in. x 20 in. AMR Boxes & Covers (Dual AMR Boxes for D1200 Lids), standard commercial grade

**Specifications:** The 13 in. x 20 in. body is tapered and has a minimum wall thickness of 0.250 in. The body has a double wall at the top cover seat area with a minimum thickness of 0.187 in. The cover seat area has 30 structural support ribs on the underside of the seat, each with a minimum thickness of 3/16 in. The bottom of the body has a 1 in. flange. The 14 in. x 19 in. cover has an average thickness of 0.250 in.

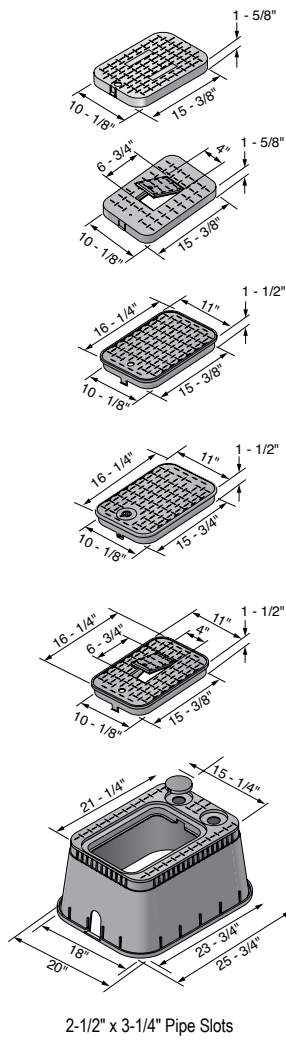

Part No.	Description - Marking	Color (Box/Cover)	Pallet Qty.	Weight Ea. (lbs.)	Product Class
<b>Drop-in Box &amp; Cover</b>					
D15AMR2-DI	13" x 20" x 12" Jumbo AMR Box, Drop-in Solid Plastic Cover - Water Meter	Black/Black	48	16.20	20ME
D15AMR2-DOULSB	13" x 20" x 12" Jumbo AMR Box, Overlapping Cover with Dual Pipe Slots on Reader End - Water Meter	Black/Black	48	16.00	20ME
<b>Drop-in Cover Only</b>					
D1200-DISBL	14" x 19" Drop-in Solid Plastic Cover - Water Meter	Black	216	2.20	20ME
D1200-OLSPL	D1200-OLSPL 14" x 19" Overlapping Solid Plastic Cover -- Reclaimed Water	Purple	216	2.14	20ME
D1200-DICIRLID	14" x 19" Drop-in Meter Reader Plastic w/ Cast Iron Reader Cover - Water Meter	Black	216	3.40	20ME
<b>Overlapping Cover Only</b>					
D1200-OLSBL	14" x 19" Overlapping Solid Plastic Cover - Water Meter	Black	216	2.40	20ME
D1200-OLSPL	14" x 19" Overlapping Solid Plastic Cover - Reclaimed Water	Purple	216	2.40	20ME
D1200-OLLOCBLD	14" x 19" Overlapping Locking Solid Plastic Cover - Water Meter	Black	100	2.60	20ME
<b>Box Only</b>					
D15AMR2-B/O	13" x 20" x 12" Jumbo AMR Box with No Pipe Slots	Black	48	12.09	20ME
D15AMR2-DU B/O	13" x 20" x 12" Jumbo AMR Box with Dual Pipe Slots Reader End	Black	48	10.20	20ME
D15AMR2-PS B/O	Jumbo AMR Box with Pipe Slot on Each End	Black	48	10.20	20ME

## 13 in. x 20 in. Jumbo Boxes & AMR Covers, standard commercial grade

**Specifications:** The 13 in. x 20 in. body is tapered and has a minimum wall thickness of 0.250 in. The body has a double wall at the top cover seat area with a minimum thickness of 0.187 in. The cover seat has 56 structural support ribs on the underside of the seat, each with a minimum thickness of 1/50 in. The bottom of the body has a 1 in. flange. The 13 in. x 20 in. cover has an average thickness of 0.25 in.

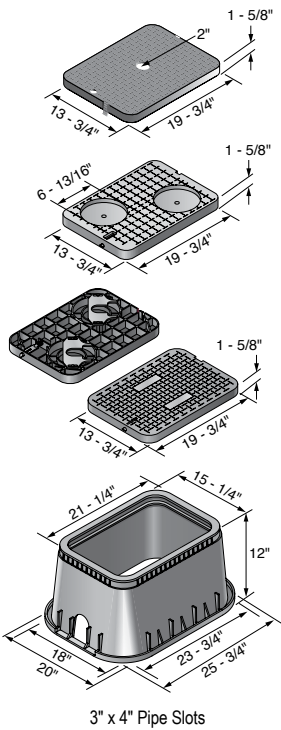

Part No.	Description - Marking	Color (Box/Cover)	Pallet Qty.	Weight Ea. (lbs.)	Product Class
<b>Drop-in Box &amp; Cover</b>					
D15-BAMR	13" x 20" x 12" Jumbo Box, Drop-in Locking Solid Plastic w/Double Bottom Mount AMR Brackets Cover - Water Meter	Black/Black	48	24.40	20ME
D15DU-BAMR	13" x 20" x 12" Dual Pipe Slot Box, Drop-in Locking Solid Plastic w/ Double Bottom Mount AMR Brackets Cover - Water Meter	Black/Black	48	23.91	20ME
D1500-DISBTR	13" x 20" x 12" Jumbo Box, Drop-in Solid Plastic w/ Single Custom AMR/TR Hole Cover - Water Meter	Black/Black	48	13.20	20ME
<b>Drop-in Cover Only</b>					
D15-BAMRL	13" x 20" Drop-in Locking Solid Plastic w/ Double Bottom Mount AMR Brackets Cover - Water Meter	Black	96	15.00	20ME
<b>Box Only</b>					
D1500-B/O	13" x 20" x 12" Jumbo Box with Pipe Slot at Each End	Black	48	9.40	20ME
D1500-DUB/O	13" x 20" x 12" Dual Pipe Slot Box (2 Slots at One End, 1 Slot at Opposite End)	Black	48	8.91	20ME
D750E-EXT	13" x 20" x 6" Extension	Black	36	5.60	20ME

## Meter Boxes

### D109 Meter Boxes, standard commercial grade

**Specifications:** The 6 in. round body is tapered and has a minimum wall thickness of 0.13 in. The body has a double wall at the top cover seat area with a minimum thickness of 0.125 in. The bottom of the body has a 0.250 in. flange. The 6 in. round cover has an average thickness of 0.15 in.

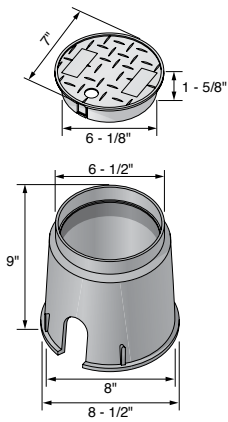

2-1/4" x 2-3/4" Pipe Slots

Part No.	Description - Marking	Color (Box/Cover)	Pallet Qty.	Weight Ea. (lbs.)	Product Class
<b>Box &amp; Cover</b>					
D109-B	6" Round Box, Overlapping Solid Plastic Cover - Water Meter	Black/Black	900	1.21	20ME
D109-P	6" Round Box, Overlapping Solid Plastic Cover - Reclaimed Water	Purple/Purple	900	1.21	20ND
<b>Cover Only</b>					
D109-PL	6" Round Overlapping Solid Plastic Cover - Reclaimed Water	Purple	900	0.40	20ND

### D1000, standard commercial grade

**Specifications:** NDS D1000 meter boxes have a 10" x 15" x 10" body that is tapered and has a minimum wall thickness of 0.13". The body has a double wall at the top cover seat area with a minimum thickness of 0.20". The cover seat area has 12 structural support ribs on the underside of the seat, each with a minimum thickness of 0.13". The bottom of the body has a 0.75" flange.

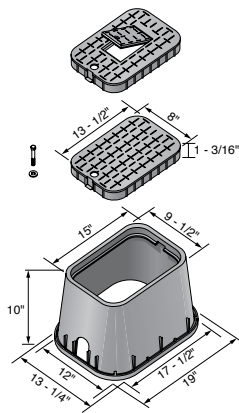

2" x 3" Pipe Slot

Part No.	Description - Marking	Color (Box/Cover)	Pallet Qty.	Weight Ea. (lbs.)	Product Class
<b>Drop-in Box &amp; Cover</b>					
D1000-SB	10" x 15" x 10" Box, Drop-in Solid Plastic Cover - Water Meter	Black/Black	96	5	20ME
D1000-RB	10" x 15" x 10" Box, Drop-in Meter Reader Plastic w/ Plastic Reader Cover - Water Meter	Black/Black	96	5	20ME
<b>Drop-in Cover Only</b>					
D1000-SBL	10" x 15" Drop-in Meter Solid Plastic Cover - Water Meter	Black	300	1.4	20ME
D1000-RBL	10" x 15" Drop-in Meter Reader w/ Plastic Reader Cover - Water Meter	Black	300	1.6	20ME

## D1200 Meter Boxes, standard commercial grade

**Specifications:** NDS D1200 meter boxes have a 14 in. x 19 in. x 12 in. body is tapered and has a minimum wall thickness of 0.25 in. The body has a double wall at the top cover seat area with a minimum thickness of 0.187 in. The cover seat area has 30 structural support ribs on the underside of the seat, each with a minimum thickness of 3/16 in. The bottom of the body has a 1 in. flange. The D1200 cover has a minimum thickness of 0.250 in.

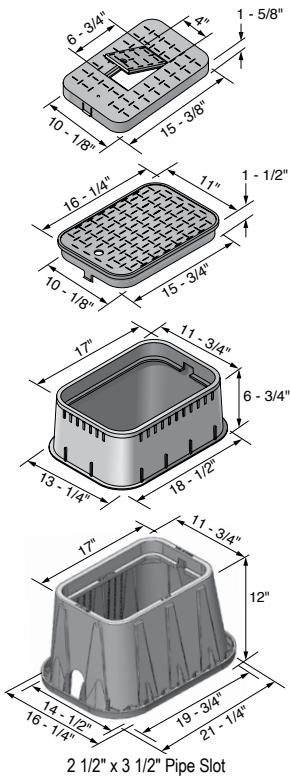

Part No.	Description - Marking	Color (Box/Cover)	Pallet Qty.	Weight Ea. (lbs.)	Product Class
<b>Drop-in Box &amp; Cover</b>					
D1200-DISB	14" x 19" x 12" Standard Box, Drop-in Solid Plastic Cover - Water Meter	Black/Black	72	9.00	20ME
D1200-DISBSWR	14" x 19" x 12" Standard Box, Drop-in Solid Plastic Cover - Sewer	Black/Black	72	9.00	20ME
D1200-DISGSWR	14" x 19" x 12" Standard Box, Drop-in Solid Plastic Cover - Sewer	Black/Green	72	9.00	20ME
D1200-DISBLU	14" x 19" x 12" Standard Box, Drop-in Solid Plastic Cover - Water Meter	Black/Blue	72	9.00	20ME
D1200-DIRB	14" x 19" x 12" Standard Box, Drop-in Solid Plastic Cover - Water Meter	Black/Black	72	9.00	20ME
D1200-DIBLRD	14" x 19" x 12" Standard Box, Drop-in Meter Reader Plastic w/ Plastic Reader Cover - Water Meter	Black/Blue	72	9.00	20ME
D1200-DIRG	14" x 19" x 12" Standard Box, Drop-in Meter Reader Plastic w/ Plastic Reader Cover - Water Meter	Black/Green	72	9.00	20ME
D1200-DICIR	14" x 19" x 12" Standard Box, Drop-in Meter Reader Plastic w/ Cast Iron Reader Cover - Water Meter	Black/Black	72	10.20	20ME
D1200-DICIRBLU	14" x 19" x 12" Standard Box, Drop-in Meter Reader Plastic w/ Cast Iron Reader Cover - Water Water	Black/Blue	72	10.20	20ME
D1200P-DICIRP	14" x 19" x 12" Standard Box, Drop-in Meter Reader Plastic w/ Cast Iron Reader Cover - Reclaimed Water	Purple/Purple	72	10.20	20ME

D1200 Meter Boxes

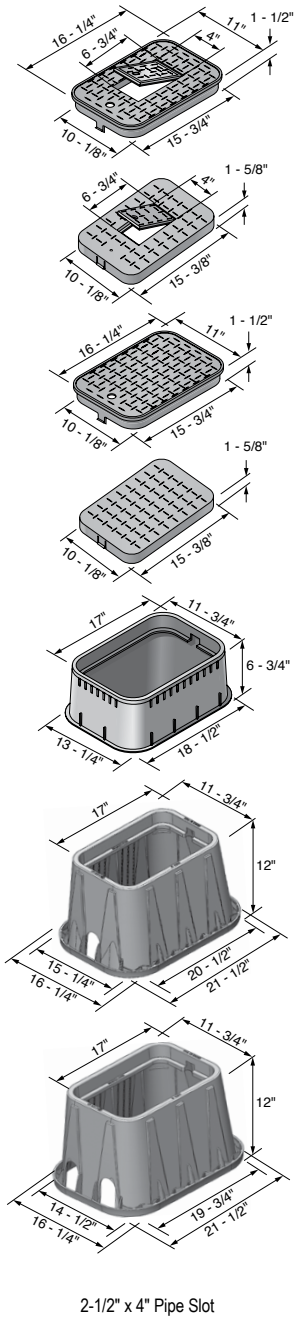

Part No.	Description - Marking	Color (Box/Cover)	Pallet Qty.	Weight Ea. (lbs.)	Product Class
<b>Overlapping Box &amp; Cover</b>					
D1200-OLSB	14" x 19" x 12" Standard Box, Overlapping Solid Plastic Cover – Water Meter	Black/Black	72	9.20	20ME
D1200-OLLOCB	14" x 19" x 12" Standard Box, Overlapping Solid Plastic Cover – Water Meter	Black/Black	72	9.40	20ME
D1200-OLRB	14" x 19" x 12" Standard Box, Overlapping Meter Reader with Plastic Reader Cover – Water Meter	Black/Black	72	9.20	20ME
D1200-CI	14" x 19" x 12" Standard Box, Overlapping Solid Cast Iron Cover – Water Meter	Black/Black	72	19.00	20ME
D1200-OLCIR	14" x 19" x 12" Standard Box, Overlapping Meter Reader Plastic with Cast Iron Reader Cover – Water Meter	Black/Black	72	10.60	20ME
D1200-CICIR	14" x 19" x 12" Standard Box, Overlapping Meter Reader Cast Iron w/ Cast Iron Reader Cover – Water Meter	Black/Black	72	10.28	20ME
<b>Drop-in Cover Only</b>					
D1200-DISBL	14" x 19" Drop-in Solid Plastic Cover – Water Meter	Black	216	2.20	20ME
D1200-DISBLUL	12" Drop in Solid Plastic Cover - Water Meter	Blue	216	2.20	20me
D1200-DISBSWRL	14" x 19" Drop-in Solid Plastic Cover – Sewer	Black	216	2.20	20ME
D1200-DISGSWRL	14" x 19" Drop-in Solid Plastic Cover – Sewer	Green	216	2.20	20ME
D1200-DIRBL	14" x 19" Drop-in Meter Reader with Plastic Reader Cover – Water Meter	Black	216	2.20	20ME
D1200-DICIRBLUL	14" x 19" Drop-in Meter Reader with Cast Iron Reader Cover – Water Meter	Blue	216	2.40	20ME
D1200-DIBLRDL	14" x 19" Drop-in Meter Reader with Plastic Reader Cover – Water Meter	Blue	216	2.20	20ME
D1200-DICIRLID	14" x 19" Drop-in Meter Reader with Cast Iron Reader Cover – Water Meter	Black	216	3.40	20ME
<b>Overlapping Cover Only</b>					
D1200-OLSBL	14" x 19" Overlapping Solid Plastic Cover – Water Meter	Black	216	2.40	20ME
D1200-OLLOCBLD	14" x 19" Overlapping Locking Solid Plastic Cover – Water Meter	Black	100	2.60	20ME
D1200-OLBLL	14" x 19" Overlapping Solid Plastic Cover – Water Meter	Blue	216	2.40	20ME
D1200-CIL	14" x 19" Overlapping Meter Reader Solid Cast Iron Cover – Water Meter	Black	216	12.20	20ME
D1200-OLCIR LD	14" x 19" Overlapping Meter Reader Plastic with Cast Iron Reader Cover – Water Meter	Black	216	3.80	20ME
<b>Box Only</b>					
D1200-B/O	14" x 19" x 12" Standard Box	Black	72	6.80	20ME
D1200-DUB/O	14" x 19" x 12" Standard Dual Pipe Slot Box	Black	72	6.80	20ME
D600E-EXT	14" x 19" x 6" Extension Only	Black	42	4.20	20ME

## D1500 Meter Boxes, standard commercial grade

**Specifications:** NDS 1500 meter boxes have a body that has a double wall at the top cover seat area with a minimum thickness of 0.187 in. The cover seat area has 30 structural support ribs on the underside of the seat, each with a minimum thickness of 1/50 in. The bottom of the body has a 1 in. flange. The 13 in. x 20 in. cover has an average thickness of 0.250 in.

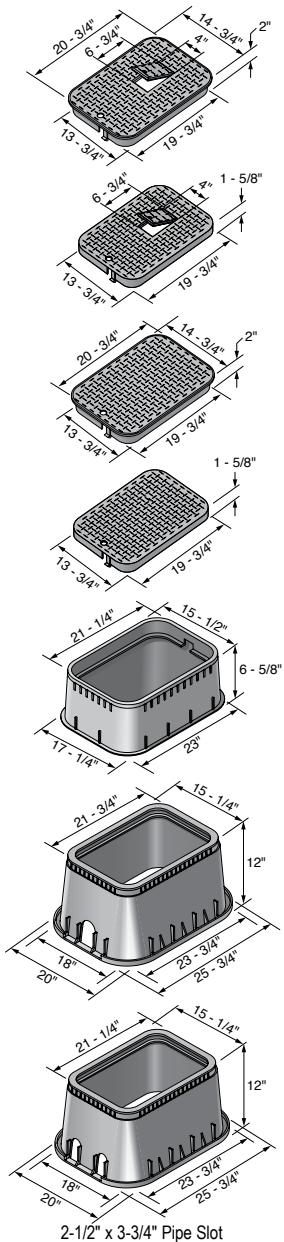

Part No.	Description - Marking	Color (Box/Cover)	Pallet Qty.	Weight Ea. (lbs.)	Product Class
<b>Drop-in Box &amp; Cover</b>					
D1500-DISB	13" x 20" x 12" Jumbo Box, Drop-in Solid Plastic Cover – Water Meter	Black/Black	48	13.20	20ME
D1500-DUDISB	13" x 20" x 12" Dual Pipe Slot Jumbo Box, Drop-in Solid Plastic Cover – Water Meter	Black/Black	48	13.49	20ME
D1500-DIRB	13" x 20" x 12" Jumbo Box, Drop-in Meter Reader Plastic w/ Plastic Reader Cover – Water Meter	Black/Black	48	13.20	20ME
D1500-DUDIRB	13" x 20" x 12" Dual Pipe Slot Jumbo Box, Drop-in Meter Reader Plastic with Plastic Reader Cover – Water Meter	Black/Black	48	13.49	20ME
D1500-DICIR	13" x 20" x 12" Jumbo Box, Drop-in Meter Reader Plastic w/ Cast Iron Reader Cover – Water Meter	Black/Black	48	14.40	20ME
D1500-DICIRBLU	13" x 20" Drop-in Meter Reader Cover, Blue Plastic with Cast Iron Reader Cover – Water Meter	Black/Blue	96	5.00	20ME
D1500-DUDICIR	13" x 20" x 12" Dual Pipe Slot Jumbo Box, Drop-in Meter Reader Plastic with Cast Iron Reader Cover – Water Meter	Black/Black	48	13.20	20me
D1500-DIRBLU	13" x 20" Drop-in Plastic Cover with Plastic Meter Reader – Water Meter	Blue/Blue	48	11.60	20ME
<b>Overlapping Box &amp; Cover</b>					
D1500-OLSB	13" x 20" x 12" Jumbo Box, Overlapping Solid Plastic Cover – Water Meter	Black/Black	48	13.20	20ME
<b>Drop-in Cover Only</b>					
D1500-DISBL	13" x 20" Drop-in Solid Plastic Cover – Water Meter	Black	96	3.80	20ME
D1500-DIRBL	13" x 20" Drop-in Meter Reader Plastic with Plastic Reader Cover – Water Meter	Black	96	3.80	20ME
D1500-DICIR LD	13" x 20" Drop-in Meter Reader Plastic with Cast Iron Reader Cover – Water Meter	Black	96	5.00	20ME
<b>Overlapping Cover Only</b>					
D1500-OLSBL	13" x 20" Jumbo Overlapping Solid Plastic Cover – Water Meter	Black	96	3.80	20ME
<b>Box Only</b>					
D1500-B/O	13" x 20" x 12" Jumbo Box	Black	48	9.40	20ME
D1500-DUB/O	13" x 20" x 12" Dual Pipe Slot Jumbo Box	Black	48	8.91	20ME
D750E-EXT	13" x 20" x 6" Extension Only	Black	36	5.60	20ME



## D1800 Meter Boxes, standard commercial grade

D1800 Meter Boxes are to be used with D1200 covers, see page 178 and page 183.

**Specifications:** NDS meter boxes have a body that is tapered and has a minimum wall thickness of 0.250 in. The body has a double wall at the top cover seat area with a minimum thickness of 0.22 in. The cover seat area has 26 structural support ribs on the underside of the seat, each with a minimum thickness of 0.12 in. The bottom of the body has a 0.50 in. flange. The 14 in. x 19 in. cover has an average thickness of 0.20 in.

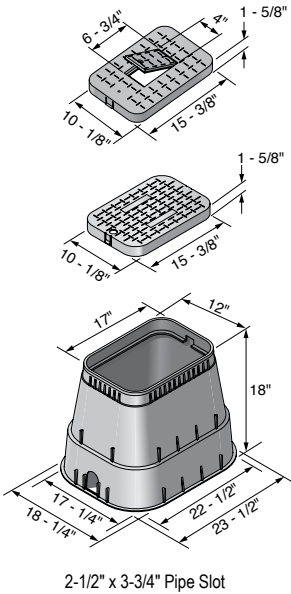

Part No.	Description - Marking	Color (Box/Cover)	Pallet Qty.	Weight Ea. (lbs.)	Product Class
<b>Drop-in Box &amp; Cover</b>					
D1800-DISB	14" x 19" x 18" Box, Drop-in Solid Plastic Cover - Water Meter	Black/Black	48	12.20	20ME
D1800-DIRB	14" x 19" x 18" Box, Drop-in Meter Reader Plastic w/ Plastic Reader Cover - Water Meter	Black/Black	48	12.20	20ME
D1800-DICIR	14" x 19" x 18" Box, Drop-in Meter Reader Plastic w/ Cast Iron Reader Cover - Water Meter	Black/Black	48	13.40	20ME
<b>Overlapping Box &amp; Cover</b>					
D1800-OLSG	14" x 19" Overlapping Cover - ICV	Black/Green	48	12.40	20ME
<b>Drop-in Cover Only</b>					
D1200-DISBL	14" x 19" Drop-in Box Solid Plastic Cover - Water Meter	Black	216	2.20	20ME
D1200-DIRBL	14" x 19" Drop-in Meter Reader w/ Plastic Reader Cover - Water Meter	Black	216	2.20	20ME
D1200-DICIRLID	14" x 19" Drop-in Meter Reader w/ Cast Iron Reader Cover - Water Meter	Black	216	3.40	20ME
D1200-DISBSWRL	14" x 19" Drop-in Solid Plastic Cover - Sewer	Black	216	2.20	20ME
<b>Box Only</b>					
D1800-B/O	14" x 19" x 18" Box	Black	48	10.00	20ME
D1800-B/O NH	14" x 19" x 18" Box, No Pipe Slots	Black	48	10.00	20ME
D1800-B/O WHT	14" x 19" Box	White	48	10.00	20ME

## D2400 Meter Boxes, standard commercial grade

**Specifications:** NDS 16 in. round meter pits and covers are injection molded of structural foam recycled polyolefin material with a melt index between 10-12. Coloring and UV stabilizers are added, along with processing lubricants when needed. The 16 in. round meter pit body is tapered and has a minimum wall thickness of 0.2615 in. The body has a double wall at the top cover seat area with a minimum thickness of 0.2780 in. The cover seat area has 8 structural support ribs on the underside of the seat, each with a minimum thickness of 0.0995 in. The bottom of the body has a 1/2 in. flange which flares to 1-1/4 in. at bolt hole. The 12-3/8 in. cover has an average thickness of 0.375 in.

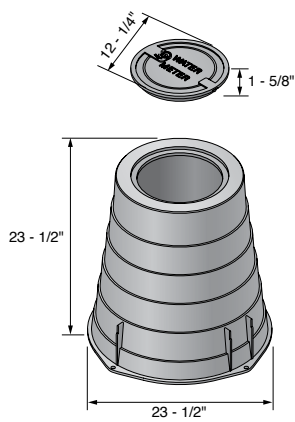

Part No.	Description - Marking	Color (Box/Cover)	Pallet Qty.	Weight Ea. (lbs.)	Product Class
<b>Box &amp; Cover</b>					
D2400-18LOCSB	18" Meter Pit, Overlapping Locking Solid Plastic Cover - Water Meter	Black/Black	40	11.40	20ME
D2400-LOCSB	24" Meter Pit, Overlapping Locking Solid Plastic Cover - Water Meter	Black/Black	52	17.53	20ME
<b>Cover Only</b>					
D2400-LOCSWBL	Overlapping Locking Solid Plastic Cover - Water Meter	Black	52	1.60	20ME
<b>Box Only</b>					
D2400-18 B/O	18" Meter Pit	Black	40	9.80	20ME
D2400-B/O	24" Meter Box	Black	52	14.00	20ME

## Meter Box Accessories



Part No.	Description	Color (Box/Cover)	Pallet Qty.	Weight Ea. (lbs.)	Product Class
DKEY	Brass Locking Key, Used with Locking Lids	Brass	1	0.50	20ME

## NDS Pro Series Meter Boxes

### 6 in. Round Meter Boxes, premium commercial grade

**Specifications:** The NDS 6 in. round meter boxes and covers are injection molded of structural foam polyolefin material with a melt index between 10-12. Coloring and UV stabilizers are added, along with processing lubricants when needed. The 6 in. round body is tapered and has a minimum wall thickness of 0.20 in. The body has a double wall at the top cover seat area with a minimum thickness of 0.13 in. The bottom of the body has a 0.250 in. flange. The 6 in. round cover has an average thickness of 0.187 in.

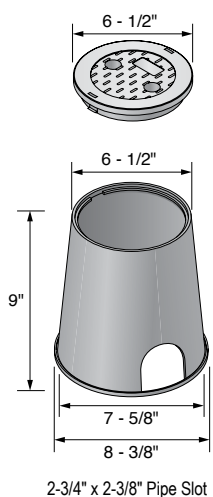

Part No.	Description - Marking	Color (Box/Cover)	Pallet Qty.	Weight Ea. (lbs.)	Product Class
<b>Box &amp; Cover</b>					
107BCW	6" Round Box, Overlapping Solid Plastic Cover - Water	Black/Green	250	1.50	20NM
107BCR	6" Round Box, Overlapping Solid Plastic Cover - Reclaimed Water	Black/Purple	250	1.50	20ND
107PBCR	6" Round Box, Overlapping Solid Plastic Cover - Reclaimed Water	Purple/Purple	250	1.50	20ND
107BCS	6" Round Box, Overlapping Solid Plastic Cover - Sewer	Black/Green	250	1.50	20NM
<b>Cover Only</b>					
107CW	6" Overlapping Solid Plastic Cover - Water	Green	800	0.40	20NM
107CR	6" Overlapping Solid Plastic Cover - Reclaimed Water	Purple	800	0.40	20ND
107CS	6" Overlapping Solid Plastic Cover - Sewer	Green	800	0.40	20NM
<b>Box Only</b>					
107B	6" Round Box	Black	250	1.23	20ND

### 10 in. Round Meter Boxes, premium commercial grade

**Specifications:** The NDS 10 in. round meter boxes and covers are injection molded of structural foam polyolefin material with a melt index between 10-12. Coloring and UV stabilizers are added, along with processing lubricants when needed. The 10 in. round body is tapered and has a minimum wall thickness of 0.30 in. The cover seat area has 8 structural support ribs on the underside of the seat, each with a minimum thickness of 0.250 in. The bottom of the body has a 0.50 in. flange. The 10 in. round cover has an average thickness of 0.30 in. The meter box has the patented Universal Locking Mechanism (ULM) that enables various sizes of bolts/screws to secure cover ranging in sizes from 5/16 in. to 3/8 in. diameter and minimum 1-1/2 in. length. Nut is no longer needed. A speed or clip nut slot also exists (clip nut not supplied).

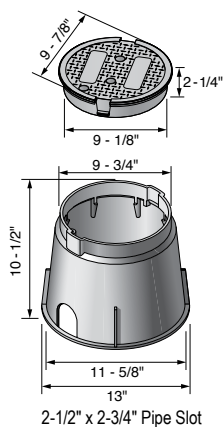

Part No.	Description	Color (Box/Cover)	Pallet Qty.	Weight Ea. (lbs.)	Product Class
<b>Box &amp; Cover</b>					
111BCS	10" Round Box, Overlapping Solid Plastic Cover - Sewer	Black/Green	180	3.00	20NM
212BCS	10" Round Box, Round Overlapping Solid Plastic Cover - Sewer	Green/Green	120	4.50	20PR
<b>Cover Only</b>					
111CS	10" Round Overlapping Solid Plastic Cover - Sewer	Green	300	1.00	20NM

## 14 in. x 19 in. Meter Boxes, premium commercial grade

**Specifications:** The NDS 14 in. x 19 in. meter boxes and covers are injection molded of structural foam polyolefin material with a melt index between 10-12. Coloring and UV stabilizers are added, along with processing lubricants when needed. The 14 in. x 19 in. body is tapered and has a minimum wall thickness of 0.250 in. The body has a double wall at the top cover seat area with a minimum thickness of 0.250 in. The cover seat area has 16 structural support ribs on the underside of the seat, each with a minimum thickness of 0.250 in. The bottom of the body has a 0.50 in. flange. The 12 in. x 20 in. cover shall have an average thickness of 0.250 in. The meter box has the patented Universal Locking Mechanism (ULM) that enables various sizes of bolts/screws to secure cover ranging in sizes from 3/8 to 1/2 in. diameter and minimum 2-1/2 in. length. Nut is no longer needed. A speed or clip nut slot also exists (clip nut not supplied). The 6 in. straight wall extensions have a 3/8 in. brass nut for bolt-down as a standard feature.

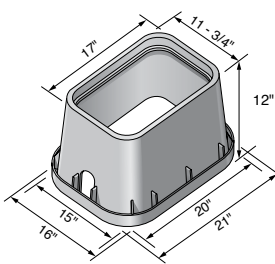
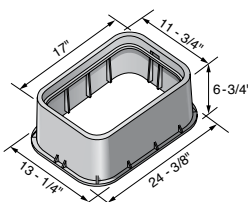
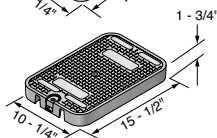
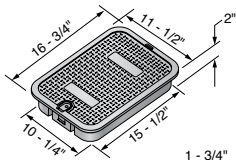
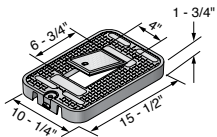
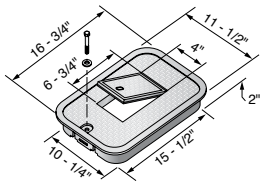

2-3/4" x 2-1/2" Pipe Slot

Part No.	Description - Marking	Color (Box/Cover)	Pallet Qty.	Weight Ea. (lbs.)	Product Class
<b>Drop-in Box &amp; Cover</b>					
113BCDW	14" x 19" x 12" Box, Drop-in Solid Plastic Cover - Water	Black/Black	78	8.00	20NM
113BCDS	14" x 19" x 12" Box, Drop-in Solid Plastic Cover - Sewer	Black/Green	78	8.00	20NM
<b>Overlapping Box &amp; Cover</b>					
113BCW	14" x 19" x 12" Box, Overlapping Solid Plastic Cover - Water	Black/Black	78	9.32	20NM
113BCS	14" x 19" x 12" Box, Overlapping Solid Plastic Cover - Sewer	Black/Green	78	9.32	20NM
113BCE	14" x 19" x 12" Box, Overlapping Solid Plastic Cover - Electrical	Green/Green	78	9.32	20NM
113BCR	14" x 19" x 12" Box, Overlapping Solid Plastic Cover - Reclaimed Water	Black/Purple	78	9.10	20ND
113PBCR	14" x 19" x 12" Box, Overlapping Solid Plastic Cover - Reclaimed Water	Purple/Purple	78	9.29	20ND
113BCM	14" x 19" x 12" Box, Overlapping Meter Reader Plastic w/ Plastic Reader Cover - Water Meter	Black/Black	78	8.92	20NM
213PBCR	14" x 19" Box, Overlapping Solid Plastic Cover - Reclaimed Water	Purple/Purple	78	9.00	20PR
<b>Overlapping Cover Only</b>					
113CW	14" x 19" Overlapping Solid Plastic Cover - Water	Black	300	2.30	20NM
114CW	14" x 19" Overlapping Solid Plastic Cover - Water	Green	300	2.30	20NM
113CR	14" x 19" Overlapping Solid Plastic Cover - Reclaimed Water	Purple	300	2.50	20ND
113CE	14" x 19" Overlapping Solid Plastic Cover - Electric	Green	300	2.30	20NM
<b>Box Only</b>					
113B	14" x 19" x 12" Box	Black	78	6.00	20NM
113-6	14" x 19" x 6" Extension	Black	49	4.00	20ND
114-6	14" x 19" x 6" Extension	Green	49	3.86	20ND
113BB	3/8" x 2-1/2" SS Bolt	Steel	(Bag of 10)	0.10	20NM

### 13 in. x 20 in. Meter Boxes, premium commercial grade

**Specifications:** The NDS 13 in. x 20 in. meter boxes and covers are injection molded of structural foam polyolefin material with a melt index between 10-12. Coloring and UV stabilizers are added, along with processing lubricants when needed. The 13 in. x 20 in. body is tapered and has a minimum wall thickness of 0.250 in. The body has a double wall at the top cover seat area with a minimum thickness of 0.250 in. The cover seat area has 16 structural support ribs on the underside of the seat, each with a minimum thickness of 0.250 in. The bottom of the body has a 0.50 in. flange. The 13 in. x 20 in. cover has an average thickness of 0.250 in. The meter box has a 3/8 in. brass nut for the bolt-down as a standard feature.

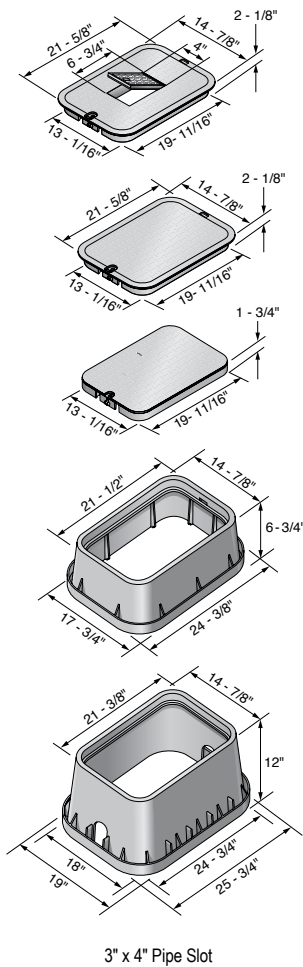

Part No.	Description - Marking	Color (Box/Cover)	Pallet Qty.	Weight Ea. (lbs.)	Product Class
<b>Overlapping Box &amp; Cover</b>					
117BCS	13" x 20" x 12" Box, Overlapping Solid Plastic Cover - Sewer	Black/Green	56	14.00	20NM
117B12CW	13" x 20" x 12" Valve Box with Overlapping Cover - Water	Black/Black	56	14.00	20NM
<b>Overlapping Cover Only</b>					
117CW	13" x 20" Overlapping Solid Plastic Cover - Water Meter	Black	180	5.00	20NM
117CS	13" x 20" Overlapping Solid Plastic Cover - Sewer	Green	180	5.00	20NM
<b>Box Only</b>					
117B	13" x 20" x 12" Box, Single Inlet, Single Outlet	Black	56	8.14	20NM
117-6	13" x 20" x 6" Jumbo Extension	Black	32	6.88	20ND
113BB	3/8" x 2-1/2" SS Bolt	Steel	(Bag of 10)	0.10	20NM

## 13 in. x 24 in. Meter Boxes, premium commercial grade

**Specifications:** The NDS 13 in. x 24 in. meter boxes and covers are injection molded of structural foam polyolefin material with a melt index between 10-12. Coloring and UV stabilizers are added, along with processing lubricants when needed. The 13 in. x 24 in. body is tapered and has a minimum wall thickness of 0.27 in. The body has a double wall at the top cover seat area with a minimum thickness of 0.27 in. The cover seat area has 18 structural support ribs on the underside of the seat, each with a minimum thickness of 0.250 in. The bottom of the body has a 1 in. flange. The 13 in. x 24 in. cover has an average thickness of 0.32 in. The meter box has a 3/8 in. Brass nut for the bolt-down as a standard feature.

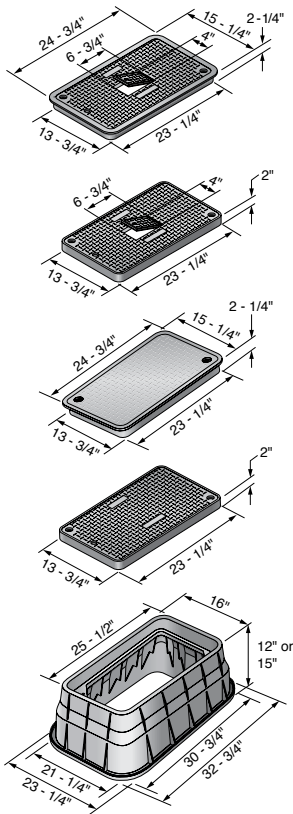

Part No.	Description - Marking	Color (Box/Cover)	Pallet Qty.	Weight Ea. (lbs.)	Product Class
<b>Drop-in Box &amp; Cover</b>					
121BCDWB	13" x 24" x 12" Box, Bolt-Down Drop-in Solid Plastic Cover - Water	Black/Black	12	22.78	20NM
121BCDMCIFB	13" x 24" x 12" Box, Bolt-Down Drop-in Meter Reader Plastic w/ Cast Iron Reader Cover - Water Meter	Black/Black	12	23.13	20NM
125BCDMCIFB	13" x 24" x 15" Box, Bolt-Down Drop-in Meter Reader Plastic w/ Cast Iron Reader Cover - Water Meter	Black/Black	12	26.13	20NM
<b>Overlapping Box &amp; Cover</b>					
125PBCRB	13" x 24" x 15" Box, Bolt-Down Overlapping Solid Plastic Cover - Reclaimed Water	Purple/Purple	12	26.44	20ND
<b>Drop-in Cover Only</b>					
121CDMCI	13" x 24" Drop-in Meter Reader Plastic w/ Cast Iron Reader Cover - Water Meter	Black	125	7.13	20NM
<b>Box Only</b>					
325B	13" x 24" x 15" Box	Black	12	19.00	20NM

## 17 in. x 30 in. Meter Boxes, premium commercial grade

**Specifications:** The NDS 17 in. x 30 in. meter boxes and covers are injection molded of structural foam polyolefin material with a melt index between 10-12. Coloring and UV stabilizers are added, along with processing lubricants when needed. The 17 in. x 30 in. body is tapered and has a minimum wall thickness of 0.32 in. The body has a double wall at the top cover seat area with a minimum thickness of 0.32 in. The cover seat area has 20 structural support ribs on the underside of the seat, each with a minimum thickness of 0.250 in. The bottom of the body has a 1 in. flange. The 17 in. x 30 in. cover has an average thickness of 0.35 in. The meter box has a 3/8 in. SS Brass for the bolt-down as a standard feature.

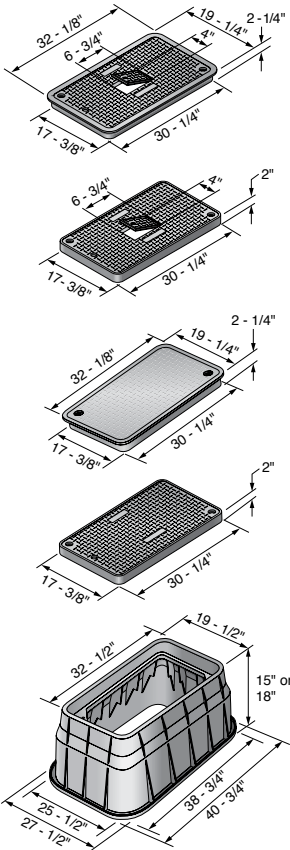

Part No.	Description - Marking	Color (Box/Cover)	Pallet Qty.	Weight Ea. (lbs.)	Product Class
<b>Drop-in Box &amp; Cover</b>					
124BCDWB	17" x 30" x 15" Box, Bolt-Down Drop-in Solid Plastic Cover - Water	Black/Black	12	34.70	20NM
126BCDMB	17" x 30" x 18" Box, Bolt-Down Drop-in Plastic w/ Plastic Reader Cover - Water Meter	Black/Black	10	41.00	20NM
126BCDMCIFB	17" x 30" x 18" Box, Bolt-Down Drop-in Plastic w/ Cast Iron Reader Cover - Water Meter	Black/Black	10	37.65	20NM
<b>Overlapping Cover Only</b>					
323CR	17" x 30" Overlapping Solid Plastic Cover - Reclaimed Water	Purple	75	11.60	20ND
<b>Drop-in Cover Only</b>					
123CDMCIF	17" x 30" Drop In Cover with Cast Iron Meter Reader	Black	75	10.30	20NM
<b>Box Only</b>					
324B BLK	17" x 30" x 15" Box	Black	6	20	20NM
326B BLK	17" x 30" x 18" Box	Black	10	23	20NM

## Index, Access Boxes

Part No.	Page	Part No.	Page	Part No.	Page	Part No.	Page	Part No.	Page
6RND-UC	175	111BCR BLK	172	113C	173	117CB	174	311C ELEC	166
10RND-UC	175	111BCS	172,187	113CB	173	117C BRN	174	311CR	166
106B	171	111BC SAND	172	113C BRN	173	117CR	174	311CRG	166
107B	171,187	111BCW	172	113CE	173,188	117CS	174,189	311CS	166
107BC	171	111C	172	113CR	173,188	117C SAND	174	311CSAND	166
107BC BLK	171	111C BLK	172	113CRG	173	117CW	174,189	311CW	166
107BCH	171	111C BRN	172	113CS	173	117PBCR	174	312B	166
107BCR	171,187	111CR	172	113C SAND	173	118-6	174	312BC	166
107BCR BLK	171	111CS	172,187	113CW	173,188	118BC	174	312BCB	166
107BCS	171,187	111C SAND	172	113PBCR	173,188	118BCS	174	312BCB ELEC	166
107BC SAND	171	111CW	172	114-6	173,188	119	174	312BCBS	166
107BC SLV	171	111CW BLK	172	114B	173	119 SAND	174	312BC ELEC	166
107BCW	171,187	111PBCR	172	114BC	173	119TBC	174	312BCRBLK	166
107C	171	112B	172	114BCS	173	119TBCR	174	312BCRG	166
107C BLK	171	112BC	172	114BCW	173	120	174	312BCS	166
107C BRN	171	112BCB	172	114CW	173,188	121BB	169	312BCSAND	166
107CH	171	112BCRG	172	115	173	121BCDMCIFB	190	312BCW	166
107CR	171,187	112BCS	172	115BCR	173	121BCDWB	190	312PB	166
107CS	171,187	113	173	115TBC	173	121CDMIF	190	312PBCBR	166
107C SAND	171	113-6	188	115TBCR	173	123CDMIF	191	312PBCR	166
107CW	171,187	113B	173,188	116	173	124BCDWB	191	313BC	167
107EBC	171	113BB	167,168,173,174,188,189	116-SAND	173	125BCDMCIFB	190	313CB	167
107PBCR	171,187	113BC	173	116TBC	173	125PBCRB	190	313CBBLK	167
108B	171	113BCBLK	173	116TBC SAND	173	126CDMB	191	313CBR	167
108BC	171	113BCD	173	117-6	174,189	126BCDMCIFB	191	313CBRBLK	167
108BCS	171	113BCDS	188	117B	174,189	212BCS	187	313CBWBLK	167
108BCW	171	113BCDW	188	117B12CW	189	213PBCR	188	313C	167
111B	172	113BCE	173,188	117BC	174	311B	166	313CBLK	167
111BB	172	113BCM	188	117BC BLK	174	311BC	166	313C ELEC	167
111BC	172	113BCR	173,188	117BCD	174	311BCB	166	313CG ELEC	167
111BCB	172	113BCRBLK	173	117BCR	174	311BCBLK	166	313CR	167
111BC BLK	172	113BCS	173,188	117BCS	174,189	311BCR	166	313CRBLK	167
111BCBW	172	113BC SAND	173	117BC SAND	174	311BCS	166	313CRG	167
111BC CTN	172	113BCW	173,188	117BCW	174	311C	166	313CSAND	167
111BCR	172	113BCWG	173	117C	174	311C BLK	166	313CW	167



## Index, Access Boxes

Part No.	Page	Part No.	Page	Part No.	Page	Part No.	Page	Part No.	Page
314B	167	321B	169	D12-BAMR	178	D1200-DICIRBLU	182	D1500-DISBL	184
314BBLK	167	321BCB	169	D12-BAMRL	178	D1200-DICIRBLUL	183	D1500-DISBTR	180
314BC	167	321BCBS	169	D12-TAMR	178	D1200-DICIRLID	179,183,185	D1500-DUB/O	180,184
314BCB	167	321BCBW	169	D12-TAMRL	178	D1200-DIRB	182	D1500-DUDICIR	184
314BCB ELEC	167	322B	169	D15AMR2-B/O	179	D1200-DIRBL	183,185	D1500-DUDIRB	184
314BCBRG	167	322BCB	169	D15AMR2-DI	179	D1200-DIRG	182	D1500-DUDISB	184
314BCBS	167	322C	169	D15AMR2-DOULSB	179	D1200-DISB	182	D1500-OLSB	184
314BCBSAND	167	322CS	169	D15AMR2-DU B/O	179	D1200-DISBL	179,183,185	D1500-OLSBL	184
314BCBW	167	322PBCBR	169	D15AMR2-PS B/O	179	D1200-DISBLU	182	D1800-B/O	178,185
314BCSAND	167	323C	170	D15-BAMR	180	D1200-DISBLUL	183	D1800-B/O NH	185
314CS	167	323CD	170	D15-BAMRL	180	D1200-DISBSWR	182	D1800-B/O WHT	185
314CW	167	323CD ELEC	170	D15DU-BAMR	180	D1200-DISBSWRL	183,185	D1800-DICIR	185
314PBCBR	167	323CDW	170	D108-G	175	D1200-DISGSWR	182	D1800-DIRB	185
314PBCR	167	323CR	170,191	D109-B	181	D1200-DISGSWRL	183	D1800-DISB	185
317BCB	168	323CS	170	D109-G	175	D1200-DITR	178	D1800-OLSG	185
317BCBBLK	168	324B	170	D109-GBOX	175	D1200-DITRL	178	D2400-18 B/O	186
317BCBW	168	324B BLK	170,191	D109-GL	175	D1200-DUB/O	183	D2400-18LOCSB	186
317C	168	324BCB	170	D109-P	175,181	D1200-OLBLL	183	D2400-B/O	186
317C BLK	168	324BCB-BG	170	D109-PL	175,181	D1200-OLCIR	183	D2400-LOCSB	186
317CR	168	324BCBS	170	D600E-EXT	178,183	D1200-OLCIR LD	183	D2400-LOCSWBL	186
317CS	168	324BCDB	170	D750E-EXT	180,184	D1200-OLLOCB	183	DKEY	186
317CSAND	168	325B	169,190	D1000-B/O	177	D1200-OLLOCLD	179,183	M2-SG	176
317CW	168	325BCB	169	D1000-RB	181	D1200-OLRB	183	M2-SG-LID	176
318B	168	326B	170	D1000-RBL	181	D1200-OLSB	183	M4-SG	176
318B BLK	168	326B BLK	170,191	D1000-SB	181	D1200-OLSBL	179,183		
318BC	168	326BCB	170	D1000-SBL	181	D1200-OLSPL	179		
318BCB	168	326BCB-BG	170	D1000-SG	177	D1200P-DICIRP	182		
318BCBRBLK	168	326BCDB	170	D1000-SGL	177	D1500-B/O	180,184		
318BCBRG	168	326BCDB-BG	170	D1200-B/O	178,183	D1500-DICIR	184		
318BCBS	168	326BCDB ELEC	170	D1200-CI	183	D1500-DICIRBLU	184		
318BCBSAND	168	326BCDBW	170	D1200-CICIR	183	D1500-DICIR LD	184		
318CW	168	326PBCBR	170	D1200-CIL	183	D1500-DIRB	184		
318PB	168	D12AMR-OLLOCL	178	D1200-DIBLRD	182	D1500-DIRBL	184		
318PBCBR	168	D12AMR-OLLOCTRBLUL	178	D1200-DIBLRDL	183	D1500-DIRBLU	184		
318PBCR	168	D12AMR-OLLOCTRL	178	D1200-DICIR	182	D1500-DISB	184		

For Access Box Technical Information, Refer to Technical Specification documents at [ndspro.com/specifications](https://ndspro.com/specifications)

# You Click. You Order. No Waiting.

Getting connected is easy... set up your account online, or call customer service. 800-726-1994.  
Se Habla Español.

## ndspro.net



The 24 hour online dealer tool that helps you manage your NDS Business

Instant Order Entry, No Wait  
Check Discount Schedules  
Check Order Status  
Pricing Query

Manage Your Account  
Invoice Printing  
Inventory Query  
News Updates



NEW! Shopping Cart  
Easy to Use & Convenient

## Terms and Conditions of Sale

**Terms:** Standard terms are NET 30 days. All invoices are to be paid in US Currency. Title and risk of loss pass to buyer upon shipment.

### **FREIGHT TERMS:**

**Continental US:** Shipments that meet the \$2,000 prepaid freight minimum are DDP (Freight Prepaid). Shipments that do not meet the \$2,000 prepaid freight minimum are FCA NDS distribution center (Freight collect).

**Canada:** Shipments are CPT- Carriage Paid to customer's location in Canada. (Customer arranges customs clearance into Canada). No returns or refunds except for wrong or damaged product received.

**All other international shipments:** Shipments are FCA NDS distribution center. (Freight collect) All sales are final, no returns or refunds will be accepted/granted except for wrong product received.

**International, Hawaii, Alaska, or Puerto Rico** shipments delivered to a US intermediary (such as a freight forwarder or consolidator location in the continental US): Shipments are considered final upon receipt and checking at the US intermediary location

### **FREIGHT ALLOWANCE:**

Prepaid levels are based on shipments to one location only. It is the responsibility of the customer to determine if your purchase order meets the minimum freight allowance required. NDS reserves the right to select the carrier and point of shipment.

**Shipments within the Continental US:**  
Freight prepaid on orders of \$2,000 NET, or more.

**Shipments to Canada, Alaska, Puerto Rico:**  
Freight prepaid on orders of \$2,500 NET, or more.

**Shipments to Hawaii:**  
Freight prepaid on orders of \$3,500 NET, or more.

**Shipments to Canada, Alaska, Hawaii, Puerto Rico orders that contain EZ Flow:**  
Freight prepaid on orders of \$4,000 NET, or more.

**Errors & Claims:** All claims for shortage in shipment or damaged material must be noted on the "Bill of Lading" and a written request for credit submitted to NDS within 15 days of shipment. NDS responsibility ceases upon delivery to the carrier.

**Returned Goods:** Returned goods will be accepted only after written approval and shipping instructions are received from NDS. A return goods authorization number is required and must be on all cartons, documents, and correspondence. All returns are subject to a 25% restocking charge, freight cost of returned goods (plus "out freight if applicable"). A higher restocking charge may be assessed against any return requiring extraordinary handling costs.

**Minimum Order:** \$100.00 minimum order net billing.

**Broken Box Charge:** A 25% broken box charge will be added for other than full box quantities. 21DI Drip Components, 25DS Dura Slope Channel and 25FC Filcoten Channel are excluded from this policy.

**Limited One Year Warranty:** The liabilities of NDS are limited solely and exclusively to replacement as set forth in our standard "Statement of Warranty", alone and do not include any liability for incidental, consequential or other damage of any kind whatsoever, whether any claim is based upon theories of contract, warranty, negligence or tort and without any limitations and do not include shipping charges, labor, installation or any other losses or expenses incurred in operation of any replacement specialty item or fitting. NDS drainage products are designed to be used for exterior surface drainage only.

All NDS products are guaranteed against defects resulting from faulty workmanship or materials. Claims for labor costs and other expenses required to replace defective products or repair of any damage resulting from the use thereof will not be allowed by NDS. Our liability is limited to replacement of products acknowledged by NDS to be defective.

**Exclusive Warranties and Remedies:** The foregoing remedies are exclusive and are given and accepted in lieu of (i) any and all other warranties, expressed or implied, including without limitation the implied warranties of merchantability and fitness for particular purpose; and (ii) any obligation, liability, right, claim or remedy in contract or tort, whether or not arising from NDS, Inc.'s negligence, actual or imputed. The remedies of customer shall be limited to those provided herein to the exclusion of any and all other remedies including, without limitation, incidental or consequential damages. No agreement varying or extending the foregoing warranties or these limitations will be binding on NDS, Inc., unless such is signed in writing by an authorized officer of NDS, Inc.

The liability of NDS, Inc., hereunder shall be limited to restoring to good working order, provided that NDS, Inc., is not required to restore the product to good working order when such failure is due to causes beyond NDS, Inc.'s control, including but not limited to, acts of God, acts of civil or military authority, priorities, strikes, floods, epidemics, war, riots, and other causes that are beyond the manufacturers control.

These provisions are complete and exclusive statements of all terms and conditions between NDS, Inc., and the consumer. These provisions may not be varied, supplemented, qualified or interpreted by any prior course of dealings, written or oral or by trade usage. No NDS, Inc. agent, officer or employee has authority to make any representation, promise or warranty concerning these provisions..

Visit [ndspro.com](http://ndspro.com) for more information



Visit [ndspro.com](https://ndspro.com) for:



Videos



Calculators



Quotes



Case Studies



Design Worx



Downloads

## ndspro.com

NDS Customer Service  
851 N. Harvard Ave., Lindsay, CA 93247  
Phone: 800.726.1994 · 559.562.9888  
Fax: 800.726.1998 · 559.562.4488  
Se Habla Español

Download our  
**Mobile App - Search  
for NDS Drainage**



A Proud Member of



**California Prop 65 Warning** | To meet the requirements of California Proposition 65, it is our responsibility to inform you of the following:  
Warning Some products sold contain chemicals known to the state of California to cause cancer, birth defects, or other reproductive harm.  
For more information, please go to [www.P65Warnings.ca.gov](http://www.P65Warnings.ca.gov)