



CHANNEL AND TRENCH DRAINS

Channel & Trench Drain Product Line-up

NDS Channel and Trench Drain Systems provide durable and proven solutions for sheet-flow drainage in applications ranging from light foot traffic to heavy vehicular traffic.

PROFILE SERIES						
Micro Channel™	Slim Channel	Mini Channel™	Spee-D® Channel	Pro Series Channel™	Dura Slope™	FILCOTEN® by NDS®
						
Pools, Spas, Patios	Patios, Pools, Spas, Walkways & Paver Landscapes	Pools, Patios, Tennis Courts	Pools, Pool Decks, Driveways	3", 5", 8" and 12", Patios, Driveways, Sports Fields	Driveways, Parking Lots, Courtyards	4", 8" and 12", Fiber-reinforced Concrete

CHANNEL & TRENCH DRAINS

Durable

Designed for maximum durability, drainage, and performance NDS Channel and Trench Drains are a proven alternative to traditional concrete drains. UV inhibitors in the plastic grate, channel and component parts prevent fading and cracking from the sun. All plastic grate and channel components are **chemically resistant, rustproof, and maintenance-free**.

Simple

NDS Plastic Channel and Trench Drains are light weight and easy to install. Grates are removable for easy clean out and replacement. Grates may be held in place with screws or hold-down clips. A complete line of accessories is available for each Channel and Trench Drain System. Our "Profile Series" of channel drains connect like PVC pipe. Our modular "Pro Series" injection-molded channel has mechanical interlocking joints. Our "Dura Slope" Trench Drain System is injection-molded, modular, has mechanical interlocking joints and a built-in slope. All NDS Channel and Trench Drain Systems easily connect to sewer and drain pipes and fittings or Sch. 40 pipes and fittings.

Versatile

To blend with surrounding surfaces, our plastic Channel Grates are available in six colors, some with decoartive options, as well as solid brass for the Mini Channel. Cast iron and rolled steel grates are available for the Dura Slope and Pro Series Channel. A ductile iron frame is also available. NDS Channel and Trench Drains also offer a choice of outletting locations; bottom, end and side options available.

Efficient

Channel and Trench Drains eliminate the need for grading a deck surface to a low area. Instead, the deck is gradually sloped in one direction or plane, and the channel drain acts as a perimeter drain at the edge of the slope to receive sheet-flow runoff. Channel and Trench Drain Systems provide more overall open surface area than conventional area grates.

Recommended Applications











- Driveways
- Warehouses
- Washdown Areas
- Loading Docks
- Tennis Courts
- Patios
- Nurseries & Greenhouses
- Plazas
- Parking Lots
- Swimming Pools & Spas
- Running Tracks
- Courtyards
- Sidewalks
- Sports Facilities
- Manufacturing Facilities
- Landings

See capacity recommendations for channel & trench drains, pages 79 & 87.

CHANNEL AND TRENCH DRAINS

Application Matrix – Choosing the Right Product

CHANNEL & TRENCH DRAINS

Top Applications		Micro Channel™	Slim Channel	Mini Channel™	Spee-D® Channel	3" Pro Series Channel™	5" Pro Series Channel™	8" Pro Series Channel™	12" Pro Series Channel™	Dura Slope™	FILCOTEN® by NDS®
	Pool Decks & Patios	●	●	●	●	●	●	●	●	●	●
	Sidewalks/Walkways	●	●	●	●	●	●	●	●	●	●
	Plaza / Courtyard		●	●	●	●	●	●	●	●	●
	Residential Driveway			●	●	●	●	●	●	●	●
	Sports Facilities						●	●	●	●	●
	Loading Dock						●	●	●	●	●
	MFG Facilities						●	●	●	●	●
	Washdown Areas						●	●	●	●	●
	Parking Lots						●	●	●	●	●
	Warehouse (hard-tire forklifts)									●	●

PROFILE CHANNEL DRAINS

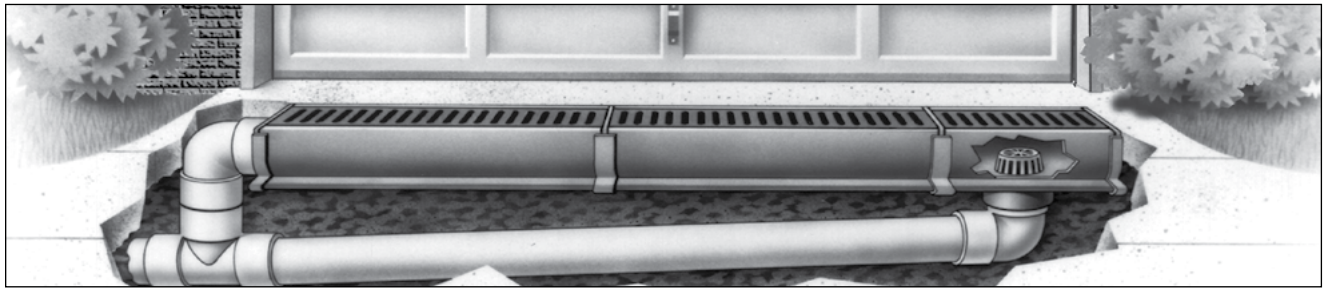

CHANNEL & TRENCH DRAINS

Details

Unique patented flying buttress design provides load-bearing support from both sides as well as underneath.

Available in three sizes: Spee-D® for driveways, large decks and commercial areas; Mini for landscapes, pools or decks; and Micro for residential pools and spas.

Unique flanges on the bottom of the channel provide an anchoring lip for straight installation and prevents floating.

Materials and Standards

- Only channels made of PVC can be cut to any length and solvent-welded like PVC pipe.
- rates available in six colors with decorative options – see individual products for details.
- Mini Channel Grate also available in solid brass.
- Channel system offers choice of bottom, end or side outlets.
- Concrete is not required under some channels for light vehicular applications. Standards vary per product.

Mini and Spee-D® Channel System Components

1. Channel
2. Grate
3. Coupling
4. End Cap or End Outlet
5. Channel Bottom Outlet
6. Sewer and Drain Fitting
7. Drain Pipe

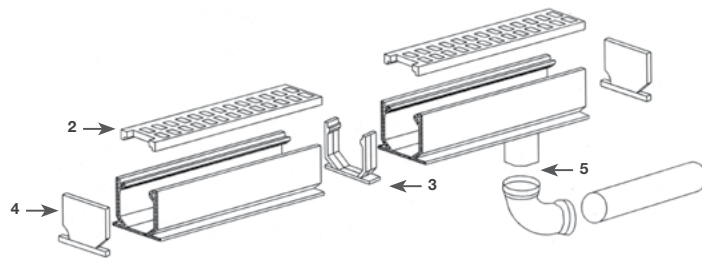

Slim Channel System Components

1. Robust extruded PVC channel available in 6-ft and 9-ft lengths
2. Anchor clips help secure the channel to a prepared base or suspend it with rebar
3. Attractive grate designs enhance any landscape and have high flow capacity for superior drainage
4. Couplers provide a secure channel-to-channel connection
5. End caps have a convenient KNOCKOUT for outletting to 1.5-in SCH 40 pipe
6. Convenient bottom outlets can be installed anywhere along the channel for 1.5-in SCH 40 pipe connections

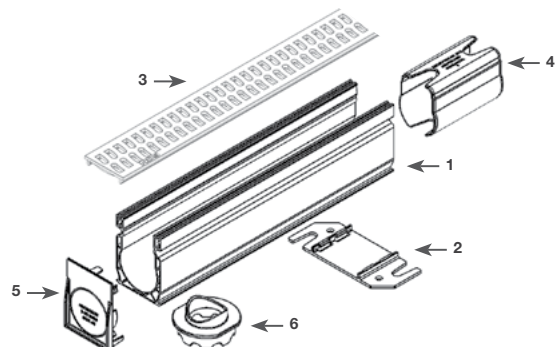

PROFILE CHANNEL DRAINS

Micro Channel™ Drains

Excellent performance at lowest possible cost. Designed for residential applications including swimming pools, spas and patios. Unique design features grate openings parallel to channel length and recessed grate for strength and effective runoff capture.

CHANNEL & TRENCH DRAINS

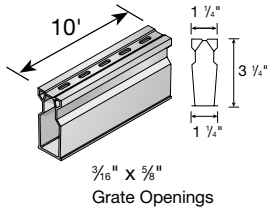

Part No.	Description	Color	Pkg. Qty.	Wt. Ea. (lbs.)	Product Class	Specifications
8001	10' Long Micro Channel	White	100 ft.	5.00	25PF	10 ft. Micro Channel with Recessed Reinforced Grate Area, Parallel Drain Slots with UV inhibitor. Open surface area 1.00 square inch per linear foot. 3.06 GPM per foot. PVC.
8002	10' Long Micro Channel	Sand	100 ft.	5.00	25PF	
8003	10' Long Micro Channel	Gray	100 ft.	5.00	25PF	
	Includes 1 coupling. (see page 79). ADA Compliant/Heel-proof.					

Micro Accessories

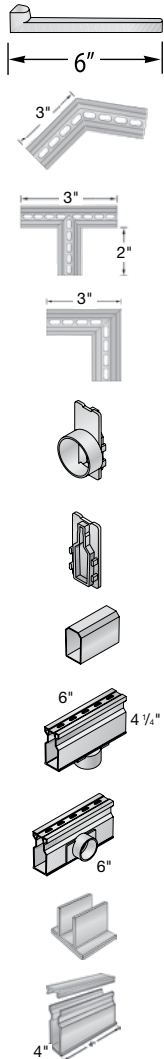



Part No.	Description	Color	Pkg. Qty.	Wt. Ea. (lbs.)	Product Class
230	6" Channel Installation Stake	Gray	24	0.04	25PF
8301	Micro Channel 45° Elbow	White	5	0.30	25PF
8302	Micro Channel 45° Elbow	Sand	5	0.30	25PF
8303	Micro Channel 45° Elbow	Gray	5	0.30	25PF
8371	Micro Channel Tee	White	5	0.40	25PF
8372	Micro Channel Tee	Sand	5	0.40	25PF
8373	Micro Channel Tee	Gray	5	0.40	25PF
8381	Micro Channel 90° Elbow	White	5	0.40	25PF
8382	Micro Channel 90° Elbow	Sand	5	0.40	25PF
8383	Micro Channel 90° Elbow	Gray	5	0.40	25PF
8461	Micro 1 1/2" Sch. 40 Spigot End Outlet	White	10	0.10	25PF
8462	Micro 1 1/2" Sch. 40 Spigot End Outlet	Sand	10	0.10	25PF
8463	Micro 1 1/2" Sch. 40 Spigot End Outlet	Gray	10	0.10	25PF
8471	Micro End Plug	White	20	0.05	25PF
8472	Micro End Plug	Sand	20	0.05	25PF
8473	Micro End Plug	Gray	20	0.05	25PF
8481	Micro Channel Couplings only Fits inside channel	White	20	0.10	25PF
8501	Micro 1 1/2" Sch. 40 Spigot Bottom Outlet	White	10	0.35	25PF
8502	Micro 1 1/2" Sch. 40 Spigot Bottom Outlet	Sand	10	0.35	25PF
8503	Micro 1 1/2" Sch. 40 Spigot Bottom Outlet	Gray	10	0.35	25PF
8511	Micro 1 1/2" Sch. 40 Spigot Side Outlet	White	10	0.35	25PF
8512	Micro 1 1/2" Sch. 40 Spigot Side Outlet	Sand	10	0.35	25PF
8513	Micro 1 1/2" Sch. 40 Spigot Side Outlet	Gray	10	0.35	25PF
8601	Micro Hold-Down Clips Use with Channel Stakes to hold channel in place	White	20	0.10	25PF
8651	Micro Channel Cleanout	White	10	0.30	25PF
8652	Micro Channel Cleanout	Sand	10	0.30	25PF
8653	Micro Channel Cleanout	Gray	10	0.30	25PF

PROFILE CHANNEL DRAINS

Slim Channel Drains

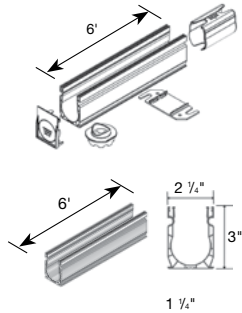
Excellent for light duty applications, including residential pools, concrete and paver patios, spas, walkways and paver landscapes.



Part No.	Description	Color	Pkg. Qty.	Wt. Ea. (lbs.)	Product Class	Specifications
9206SKIT	6 ft. Slim Channel Kits with sand plastic grates	Sand	15 EA (90 LF)	4.2	25PF	2.25" wide Channel Drain Kits & Assemblies
9206GKIT	6 ft. Slim Channel Kits with gray plastic grates	Gray	15 EA (90 LF)	4.2	25PF	
9209WHITE	9 ft. Slim Channel & Grate Assembly	White	10 EA (90 LF)	5.58	25PF	
9209SAND	9 ft. Slim Channel & Grate Assembly	Sand	10 EA (90 LF)	5.58	25PF	
9209GRAY	9 ft. Slim Channel & Grate Assembly	Gray	10 EA (90 LF)	5.58	25PF	End & bottom outlets fit 1-1/2" Schedule 40 pipe
Kits include 6 ft. channel, 2 slotted grates, 2 end caps/outlets, 2 anchor clips, 1 coupling & 1 bottom outlet						
Assemblies include 9 ft. channel and 3 slotted grates						PVC Channel with UV inhibitor
9206	6 ft. Slim Channel	Black	15 EA (90 LF)	3.00	25PF	
9209	9 ft. Slim Channel	Black	10 EA (90 LF)	4.5	25PF	See related specifications for 9241, 9242 & 9243 plastic slotted grates
 (see page 79).						

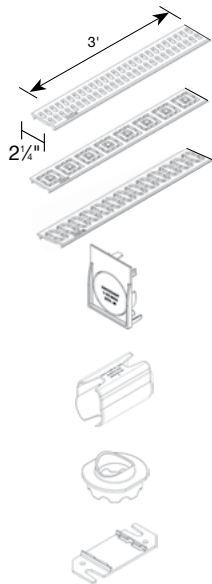

Part No.	Description	Color	Pkg. Qty.	Wt. Ea. (lbs.)	Product Class	Specifications
9241	3 ft. Slim Channel Grate	White	30 EA (90 LF)	0.36	25PF	3 ft polypropylene channel grate with UV inhibitor. Open Surface Area 7.01 square inches per foot. 21.44 GPM per foot.
9242	3 ft. Slim Channel Grate	Sand	30 EA (90 LF)	0.36	25PF	
9243	3 ft. Slim Channel Grate	Gray	30 EA (90 LF)	0.36	25PF	
9251	3 ft. Slim Channel Grate Square	White	30 EA (90 LF)	0.36	25PF	3 ft Polypropylene Decorative Square Channel Grate with UV inhibitor. Open Surface Area 5.73 square inches per foot. 21.44 GPM per foot.
9252	3 ft. Slim Channel Grate Square	Sand	30 EA (90 LF)	0.36	25PF	
9253	3 ft. Slim Channel Grate Square	Gray	30 EA (90 LF)	0.36	25PF	
9261	3 ft. Slim Channel Grate Chain	White	30 EA (90 LF)	0.36	25PF	3 ft Polypropylene Decorative Chain Channel Grate with UV inhibitor. Open Surface Area 5.73 square inches per foot. 21.44 GPM per foot.
9262	3 ft. Slim Channel Grate Chain	Sand	30 EA (90 LF)	0.36	25PF	
9263	3 ft. Slim Channel Grate Chain	Gray	30 EA (90 LF)	0.36	25PF	
 (see page 79).						

Part No.	Description	Color	Pkg. Qty.	Wt. Ea. (lbs.)	Product Class	Specifications
9247	Slim Channel End Cap/Outlet	Black	20 EA	0.04	25PF	End & bottom outlets fit 1-1/2" Schedule 40 pipe
9248	Slim Channel Coupling	Black	20 EA	0.08	25PF	
9250	Slim Channel Bottom Outlet	Black	10 EA	0.04	25PF	
9270	Slim Channel Anchor Clip	Black	20 EA	0.04	25PF	
9301	Slim Channel Fab 45	White	1 EA	0.29	25PF	
9302	Slim Channel Fab 45	Sand	1 EA	0.29	25PF	
9303	Slim Channel Fab 45	Gray	1 EA	0.29	25PF	
9371	Slim Channel Fab Tee	White	1 EA	0.41	25PF	
9372	Slim Channel Fab Tee	Sand	1 EA	0.41	25PF	
9373	Slim Channel Fab Tee	Gray	1 EA	0.41	25PF	
9381	Slim Channel Fab 90	White	1 EA	0.35	25PF	
9382	Slim Channel Fab 90	Sand	1 EA	0.35	25PF	
9383	Slim Channel Fab 90	Gray	1 EA	0.35	25PF	

CHANNEL & TRENCH DRAINS

PROFILE CHANNEL DRAINS

Mini Channel™ Drains

Excellent for light-duty applications including residential pools, concrete and paver patios, spas and tennis courts.

CHANNEL & TRENCH DRAINS

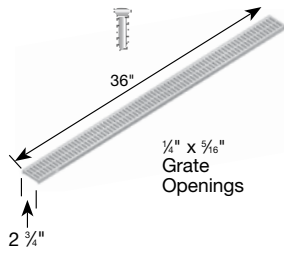

Part No.	Description	Color	Pkg. Qty.	Wt. Ea. (lbs.)	Product Class	Specifications
529	Stainless Steel Screws, FH #4 x 5/8"	Steel	64	0.10	25PF	3 ft. Structural Foam Polyolefin Channel Grate with UV inhibitor. Open surface area 9.90 square inches per foot. 30.29 GPM per foot.
540	3' Channel Grate	White	48 ft.	0.66	25PF	
541	3' Channel Grate	Gray	48 ft.	0.66	25PF	
542	3' Channel Grate	Green	48 ft.	0.66	25PF	
543	3' Channel Grate	Black	48 ft.	0.66	25PF	
544	3' Channel Grate	Sand	48 ft.	0.66	25PF	
551	3' Channel Grate	Brick Red	48 ft.	0.66	25PF	
Requires 4 screws per Grate. (see page 79). ADA Compliant/Heel-proof.						

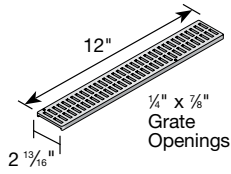

Part No.	Description	Color	Pkg. Qty.	Wt. Ea. (lbs.)	Product Class	Specifications
552B	1' Brass Channel Grate	Satin Brass	12	1.25	25PF	1 ft. Mini Channel Solid Brass Grate with brass screws. Open surface area 9.20 square inches per foot. 28.14 GPM per foot.
553PB	1' Brass Channel Grate	Polished Brass	12	1.25	25PF	
Fits #500 Mini Channel. (see page 79). ADA Compliant/Heel-proof.						

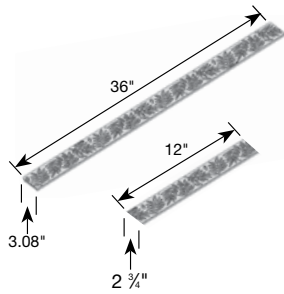

Part No.	Description	Color	Pkg. Qty.	Wt. Ea. (lbs.)	Product Class	Specifications
846	Stainless Steel Screws, FH #4 x 1"	Steel	64	0.10	25PF	3 ft. Structural Foam Polyolefin botanical pattern Channel Grate with UV inhibitor. Open surface area 5.44 square inches per foot. 16.64 GPM per foot.
554S	3' Botanical Channel Grate	Sand	16	0.89	25PF	
554GR	3' Botanical Channel Grate	Green	16	0.89	25PF	
554GY	3' Botanical Channel Grate	Gray	16	0.89	25PF	
554	3' Botanical Channel Grate	Black	16	0.89	25PF	
554CI	1' Botanical Cast Iron Channel Grate	Black*	1	1.82	25PF	1 ft. Mini Channel botanical Cast Iron Channel Grate. Open surface area 5.39 square inches per foot. 16.49 GPM per foot. Class B load rated.
Fits #500 Mini Channel. (see page 79). ADA Compliant. *Painted for shipping & display only; grate will form iron-oxide patina						

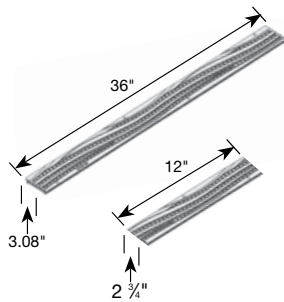

Part No.	Description	Color	Pkg. Qty.	Wt. Ea. (lbs.)	Product Class	Specifications
846	Stainless Steel Screws, FH #4 x 1"	Steel	64	0.10	25PF	3 ft. Structural Foam Polyolefin wave pattern Channel Grate with UV inhibitor. Open surface area 5.73 square inches per foot. 17.54 GPM per foot.
555S	3' Wave Channel Grate	Sand	16	0.88	25PF	
555GR	3' Wave Channel Grate	Green	16	0.88	25PF	
555GY	3' Wave Channel Grate	Gray	16	0.88	25PF	
555	3' Wave Channel Grate	Black	16	0.88	25PF	
555CI	1' Wave Cast Iron Channel Grate	Black*	1	1.30	25PF	1 ft. Mini Channel Wave Cast Iron Channel Grate. Open surface area 4.11 square inches per foot. 12.56 GPM per foot. Class B load rated.
Fits #500 Mini Channel. (see page 79). ADA Compliant. *Painted for shipping & display only; grate will form iron-oxide patina						

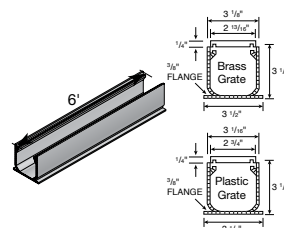

Part No.	Description	Color	Pkg. Qty.	Wt. Ea. (lbs.)	Product Class	Specifications
500	6' Mini Channel Drain	Gray	48 ft.	3.26	25PF	6 ft. PVC Mini Channel Drain with inverse flying-buttress design, bottom flange, patented honeycomb reinforced walls and UV inhibitor.
500S	6' Mini Channel Drain	Sand	48 ft.	3.26	25PF	
Grate should be recessed 1/8" below finish grade in non-traffic applications. Grate should be recessed 1/4" in traffic applications.						

PROFILE CHANNEL DRAINS

Mini Channel Accessories

Excellent for light duty applications, including residential pools, concrete and paver patios, spas and tennis courts.

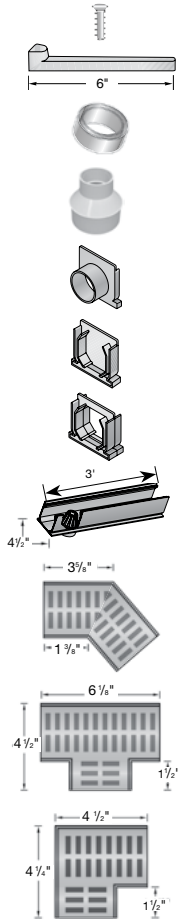

Part No.	Description	Color	Pkg. Qty.	Wt. Ea. (lbs.)	Product Class
529	Stainless Steel Screws, FH #4 x 5/8"	Steel	64	0.10	25PF
230	6" Channel Installation Stake	Gray	24	0.04	25PF
532	Adapter Bushing for Mini Channel 2" Bottom & End Outlet to 3" S&D Fittings	White	20	0.14	30PV
533	Adapter for Mini Channel 2" Bottom & End Outlet to 4" S&D Fittings	White	20	0.34	30PV
546	Mini Channel End Outlet to 2" Sch. 40 Pipe Fittings	Gray	10	0.15	25PF
546S	Mini Channel End Outlet to 2" Sch. 40 Pipe Fittings	Sand	10	0.15	25PF
547	Mini Channel End Cap	Gray	20	0.12	25PF
547S	Mini Channel End Cap	Sand	20	0.12	25PF
548	Mini Channel Coupling	Gray	20	0.12	25PF
548S	Mini Channel Coupling	Sand	20	0.12	25PF
550	3' Mini Channel Drain with Atrium Strainer and Bottom Outlet to 2" Sch. 40 Pipe Fittings	Gray	6	2.17	25PF
5300	Fabricated 45° Elbow with Grate	Gray	1	0.40	25PF
5303	Fabricated 45° Elbow with Grate	Sand	1	0.40	25PF
5370	Fabricated Tee with Grate	Gray	1	0.50	25PF
5372	Fabricated Tee with Grate	Black	1	0.50	25PF
5380	Fabricated 90° Elbow with Grate	Gray	1	0.40	25PF
5383	Fabricated 90° Elbow with Grate	Sand	1	0.40	25PF

CHANNEL & TRENCH DRAINS

Profile Channel Paver Installation

NDS Profile Channel Systems and grates are dimensionally compatible with standard 2-3/8" clay and concrete paving systems. Both decorative and standard grate options make Profile Channel an ideal choice for drainage on paver pool decks, patios, plazas, courtyards and parking courts.



PROFILE CHANNEL DRAINS

Spee-D® Channel Drains

Ideal for commercial as well as residential applications. Effective in everything from patios to light vehicular traffic areas.

CHANNEL & TRENCH DRAINS

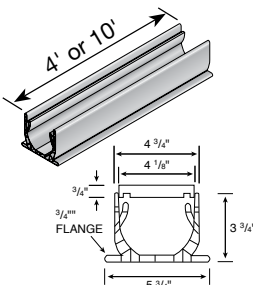
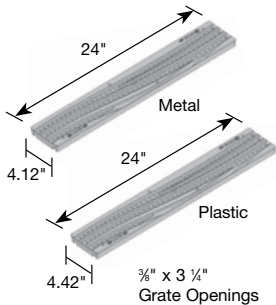
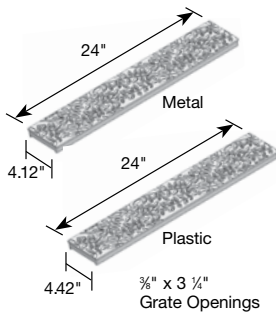
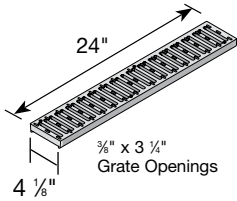

Part No.	Description	Color	Pkg. Qty.	Wt. Ea. (lbs.)	Product Class	Specifications
229	Stainless Steel Screws, FH #8 X 1" for Spee-D Channel Plastic Slotted Grates	Steel	48	0.06	25PF	2 ft. Structural Foam Polyolefin Secured Channel Grate with UV inhibitor. Open surface area 16.76 square inches per foot. 51.27 GPM per foot.
240	2' Channel Slotted Grate	White	24 ft.	1.33	25PF	
241	2' Channel Slotted Grate	Gray	24 ft.	1.33	25PF	
242	2' Channel Slotted Grate	Green	24 ft.	1.33	25PF	
243	2' Channel Slotted Grate	Black	24 ft.	1.33	25PF	
244	2' Channel Slotted Grate	Sand	24 ft.	1.33	25PF	
251	2' Channel Slotted Grate	Brick Red	24 ft.	1.42	25PF	
254	2' Galvanized Steel Channel Grate	Galvanized Steel	24 ft.	1.90	25PF	2 ft. Galvanized Steel Channel Grate. Open surface area 15.49 square inches per foot. 47.39 GPM per foot.
(see page 79). ADA Compliant.						

Part No.	Description	Color	Pkg. Qty.	Wt. Ea. (lbs.)	Product Class	Specifications
829	Stainless Steel Screws, FH #8 X 1-1/4" for Spee-D Channel Decorative Plastic Grates	Steel	40	0.15	25PF	2 ft. Structural Foam Polyolefin decorative botanical Channel Grate with UV inhibitor. Open surface area 7.78 square inches per foot. 23.80 GPM per foot.
252S	2' Channel Botanical Grate	Sand	24 ft.	1.74	25PF	
252GR	2' Channel Botanical Grate	Green	24 ft.	1.74	25PF	
252GY	2' Channel Botanical Grate	Gray	24 ft.	1.74	25PF	
252	2' Channel Botanical Grate	Black	24 ft.	1.74	25PF	2 ft. Cast Iron decorative botanical Channel Grate. Open surface area 8.99 square inches per foot. 27.50 GPM per foot. Class B load rated.
252CI	2' Cast Iron Channel Botanical Grate	Black*	2 ft.	7.06	25PF	
229	Stainless Steel Screws, FH #8 X 1" for Spee-D Channel Decorative Iron Grates	Steel	48	0.06	25PF	
(see page 79). ADA Compliant. *Painted for shipping & display only; grate will form iron-oxide patina						

Part No.	Description	Color	Pkg. Qty.	Wt. Ea. (lbs.)	Product Class	Specifications
829	Stainless Steel Screws, FH #8 X 1-1/4" for Spee-D Channel Decorative Plastic Grates	Steel	40	0.15	25PF	2 ft. Structural Foam Polyolefin decorative wave Channel Grate with UV inhibitor. Open surface area 7.78 square inches per foot. 23.80 GPM per foot.
253S	2' Channel Wave Grate	Sand	24 ft.	1.84	25PF	
253GR	2' Channel Wave Grate	Green	24 ft.	1.84	25PF	
253GY	2' Channel Wave Grate	Gray	24 ft.	1.84	25PF	
253	2' Channel Wave Grate	Black	24 ft.	1.84	25PF	2 ft. Cast Iron decorative wave Channel Grate. Open surface area 7.41 square inches per foot. 22.67 GPM per foot. Class B load rated.
253CI	2' Cast Iron Channel Wave Grate	Black*	2 ft.	7.52	25PF	
229	Stainless Steel Screws, FH #8 X 1" for Spee-D Channel Decorative Iron Grates	Steel	48	0.06	25PF	
(see page 79). ADA Compliant. *Painted for shipping & display only; grate will form iron-oxide patina						

Part No.	Description	Color	Pkg. Qty.	Wt. Ea. (lbs.)	Product Class	Specifications
400	4' Spee-D Channel Drain	Gray	24 ft.	4.83	25PF	PVC Channel Drain with Inverse Flying Buttress design, bottom flange, patented honeycomb reinforced walls and UV inhibitor.
400-10	10' Spee-D Channel Drain	Gray	60 ft.	11.00	25PF	
400-10WH	10' Spee-D Channel Drain Assembly with pre-fastened Gray Plastic Grates	Gray	60 ft.	17.5	25PF	
400-10MTL	10' Spee-D Channel Drain Assembly with pre-fastened Galvanized Steel Grates	Galvanized Steel	40 ft.	20.5	25PF	
Grate should be recessed 1/8" below finish grade in non-traffic applications. Grate should be recessed 1/4" below finished grade in traffic applications.						

PROFILE CHANNEL DRAINS

Spee-D® Accessories

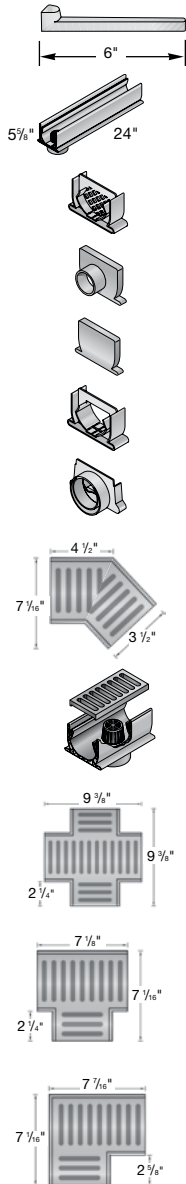

Part No.	Description	Color	Pkg. Qty.	Wt. Ea. (lbs.)	Product Class
230	6" Channel Installation Stake	Gray	24	0.04	25PF
234	2' Spee-D Channel Drain with Atrium Strainer and Bottom Outlet to 3" and 4" Sewer and Drain Fittings	Gray	12	2.67	25PF
245	Spee-D Channel Strainer Coupling	Gray	20	0.35	25PF
246	Spee-D Channel End Outlet to 2" Sch. 40 Pipe Fittings	Gray	10	0.40	25PF
247	Spee-D Channel End Cap	Gray	10	0.40	25PF
248	Spee-D Channel Coupling	Gray	20	0.40	25PF
249	Spee-D Channel Offset End Outlet to 3" Sewer and Drain Pipe and 4" Sewer and Drain Fittings	Gray	10	0.50	25PF
2301	Fabricated 45° Elbow with Grate	Gray	1	2.00	25PF
2351	7" Fabricated Grate 4" Bottom Outlet with Grate	Gray	1	1.70	25PF
2361	Fabricated Cross and Grate	Gray	1	3.00	25PF
2371	Fabricated Tee with Grate	Gray	1	3.00	25PF
2381	Fabricated 90° Elbow with Grate	Gray	1	3.00	25PF

CHANNEL & TRENCH DRAINS