

THE NEW



STANDARD



ROCHESTER CONCRETE PRODUCTS  
2024 HARDSCAPES COLLECTION



THE NEW STANDARD

# CONTOURS

LIFE'S TOO SHORT FOR BORING PAVERS!

# PORTFOLIO OF PRODUCTS

## PAVERS AND SLABS

American Brick	52
Barrington	38
Broadmoor	46
Cobble Stone	50
Colonial	51
Contours <b>(NEW)</b>	32
GeoCeramica <b>(NEW)</b>	36
Holland & Holland-Eco	54
Lamont	56
Mezzano	44
Minnetonka	42
Pacific-Eco	57
Serano	40
Silhouette <b>(NEW)</b>	34
Tahoe & Reno	48
Titan XL <b>(NEW)</b>	23
6 x 12 Accent	53

## WET CAST TILES

Antique Travertine Landscape Tiles	30
Barn Plank Landscape Tiles	26
Slate Landscape Tiles	28
Stepping Stones	
Wet Cast Steps	

## RETAINING WALLS

Barn Plank Garden Wall	58
Classic 6 and 8	68
Classic 6 Colonial	66
Cottage Stone	72
Contemporary & Cap	62
Lakeland and Riverland	76
Olympic	60
Premier 6 and 8 <b>(NEW)</b>	70
Recon	74
Rosetta Kodah and Outcropping	75
Vintage 6	64

## OUTDOOR LIVING KITS

Contemporary Kits	84
Fireplaces	88
Fire Rings	92
Grand Island Bar Grill Series	90
Pillars/Seatwalls	93
Waterfalls	93

## KITCHEN CABINET KITS

Grills	96
Island Table	98
Prep Center/Refrigerator	99
Side Burner	99
Smoker	99
Trash Drawer	99
Woodbox Stand	99

## CAPS, STEPS, EDGERS & ACCESSORIES

Bullnose Paver	80
Contemporary Cap	73
Edgers	81
Grand Step	79
Wet Cast/Chiseled Caps & Tops	82
Wet Cast Steps	78
Stepping Stones	80

## REFERENCE

Chroma Color/ Chroma Sheild	25
Paver Selector	22
Planning Guide	20
Warranty	103

### PLEASE NOTE:

Our products are made from facemix or solid color concrete for lasting appearance and durability. Photographs contained herein are for representation only. Refer to actual product samples when making color selection. Product dimensions given are nominal. See the RCP Product Guide for packaging, pallet configurations, product specifications, patterns, detailed descriptions and warranties.

The information presented here has been prepared for the benefit of customers interested in Rochester Concrete Products. Rochester Concrete Products assumes no liability for its accuracy or completeness. Final determination of the suitability of any information or material for the use contemplated, or for its manner of use, is the sole responsibility of the user. Certain products not available in all areas.

A close-up, slightly blurred image of the American flag, showing the stars and stripes in a textured, almost stone-like appearance. The flag is draped across the top half of the page.

WE ARE FAMILY-OWNED, BORN  
IN THE MIDWEST, AND MADE IN THE USA.

Rochester Concrete Products is a third-generation, family-owned manufacturer of mortarless concrete products dating back to 1914. We have consistently produced an extensive line of innovative hardscapes and building products that pass rigid quality control requirements – meeting or exceeding ASTM standards for strength, durability and freeze/thaw.



# THE NEW STANDARD

In 2024, with the addition of our newest plant in Jordan, MN, we look to take the next step and set a **NEW STANDARD** for the hardscape manufacturing industry with...

## **MIND-BLOWING COLOR**

Hardscape colors are born from state-of-the-art Chroma Coloring system. These pavers are the result of high-quality materials and precision manufacturing.

## **CONSISTENT PRODUCT**

Precise, computerized controls throughout the manufacturing process and robust inspection ensure you get the same color, same surface and same edge detail — every time.

## **UNMATCHED QUALITY**

North America's most advanced paver production facility with manufacturing systems and quality controls like no other.

## **INNOVATION**

As technologies and hardscape trends change, we're continually bringing new and innovative products, colors, shapes and sizes to the market.

## **PRODUCT AVAILABILITY**

Our technology and facilities investments dramatically increase production capacity and on-hand inventory.



Lakeland Wall  
Chiseled Pillar Cap



Lakeland Wall  
Chiseled Pillar Cap

## RETAINING & GARDEN WALLS



Classic 6 Straight Face Wall  
4" Universal Cap



Contemporary Wall  
Chiseled 2 Sided & Pillar Caps



Vintage 6 Tumbled Wall  
Chiseled 3 Sided Cap

Retaining & Garden walls can protect structures, such as homes or buildings, from the impact of soil movement. They help prevent soil pressure from damaging foundations or causing other structural issues.



Classic 6 Colonial 18 Wall  
4" Universal Cap  
Barn Plank Step



Classic Colonial 6 Wall  
Serano Paver

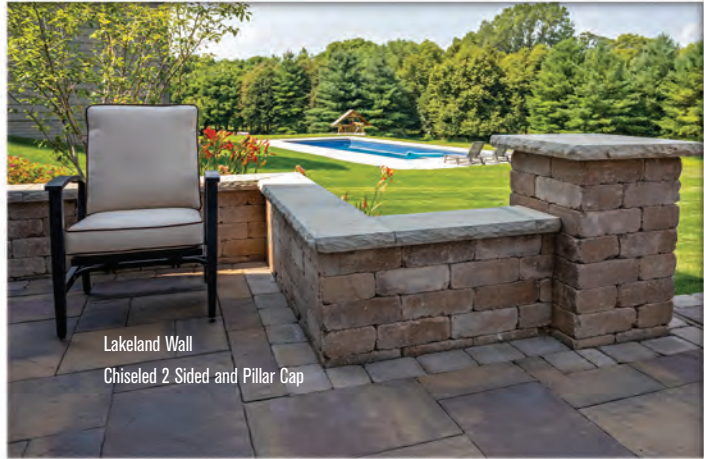

Lakeland Wall  
Chiseled 2 Sided and Pillar Cap



Classic 6 Wall  
4" Universal Cap



Lakeland Wall  
Chiseled 2 Sided and Pillar Caps



Classic Colonial 6 Wall & 4" Cap  
Lakeland Wall, Serano Paver  
Chiseled 2 Sided and Pillar Caps





Contemporary Wall  
American Brick Accent  
Chiseled Pillar Cap



Classic 6 Wall  
Chiseled Wall Cap



Classic 6 Wall  
3" Universal Cap

# DRIVEWAYS & WALKWAYS

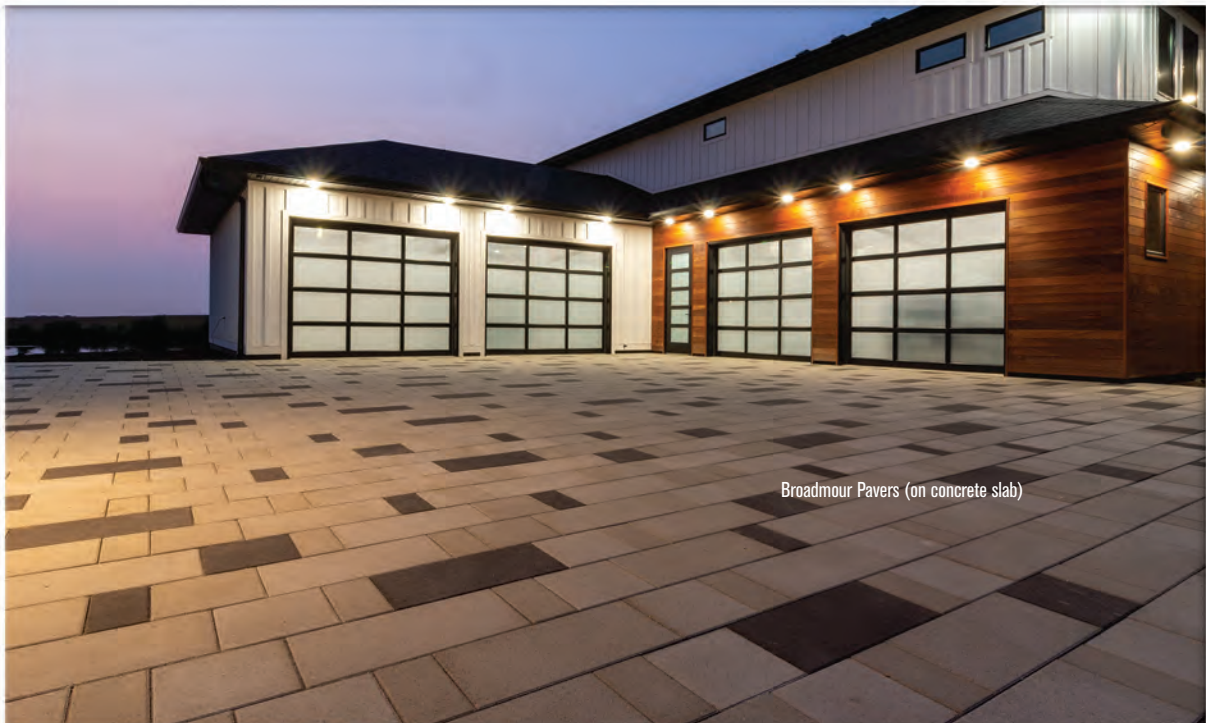

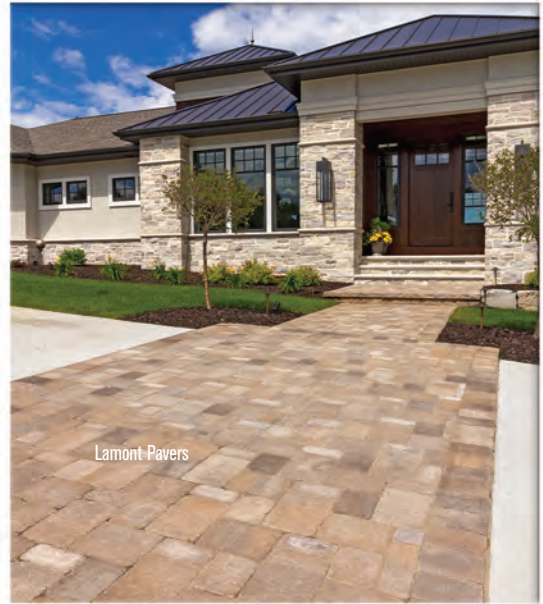
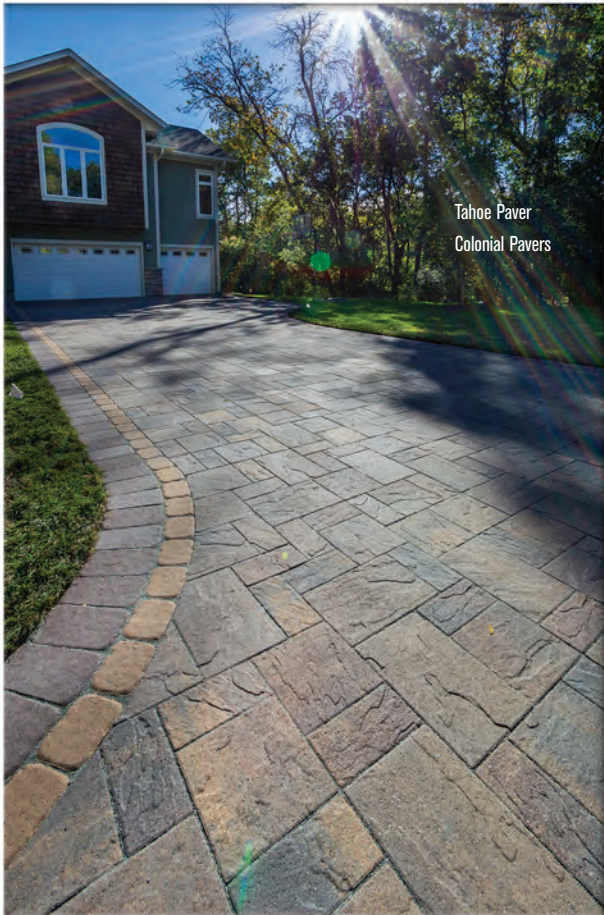

Driveway applications require pavers that can stand up to extreme use and abuse. With endless design possibilities, these smooth, embossed and tumbled pavers make an incredible first impression on visitors to your home.



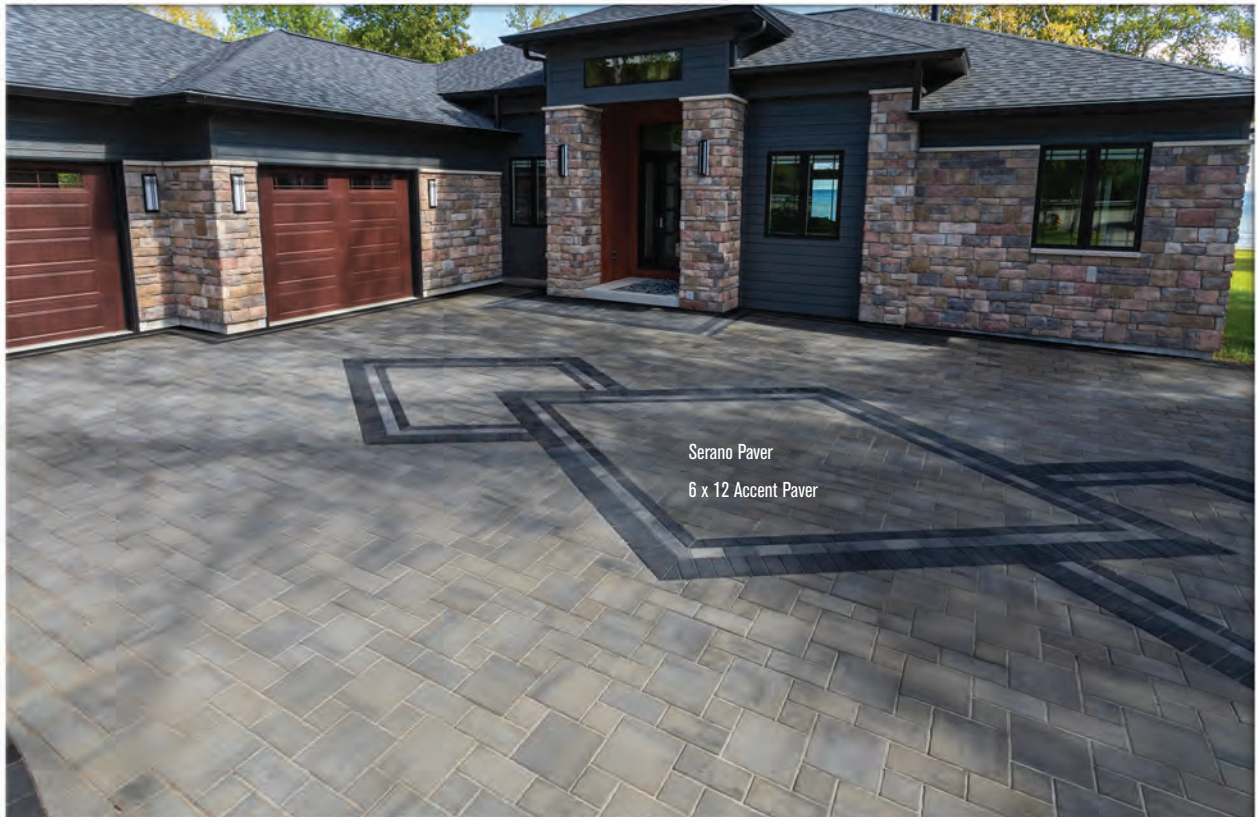
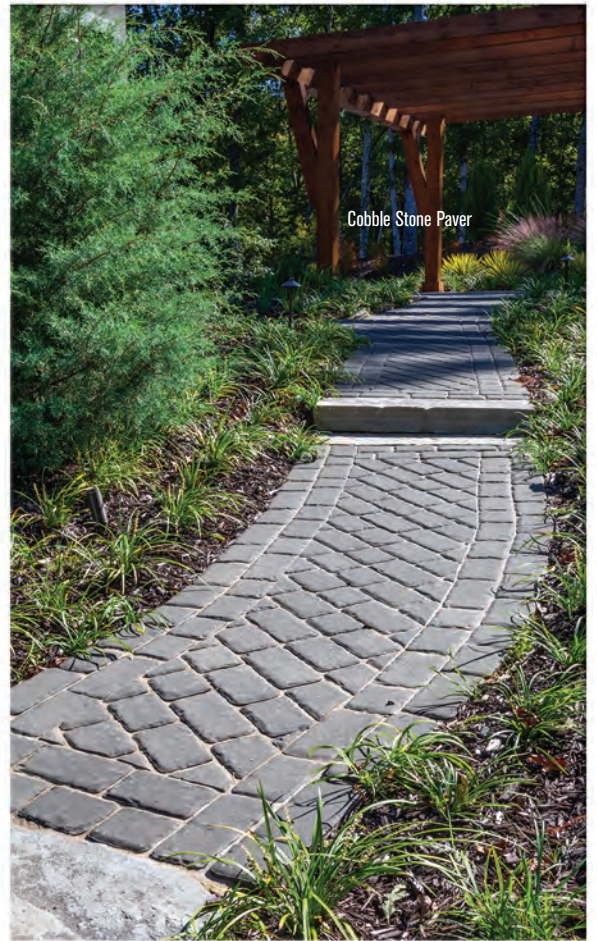



Classic 6 Beveled Wall



Holland Paver



Tahoe Paver

Colonial 6 x 9 Paver





Minnetonka Paver

## POOLS AND SHORELINES



Travertine Tile



Travertine Tile  
Bullnose Paver  
Contemporary Retaining Wall



Mezzano Paver  
Holland Paver  
Lakeland Wall



Minnetonka Paver



Broadmour Paver  
Classic 6 Wall



Barrington Paver  
Bullnose Paver  
Olympic Wall  
Contemporary Wall Cap





Mezzano Paver  
Bullnose Paver  
Colonial Pavers



Serano Paver  
6 x 12 Accent Paver  
Lakeland & Riverland Walls





Minnetonka Paver  
Holland Pavers

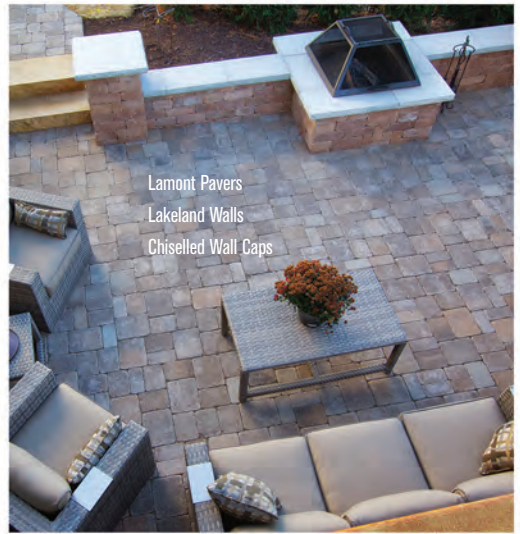

Lamont Pavers  
Lakeland Walls  
Chiselled Wall Caps

# OUTDOOR LIVING



Mezzano Pavers



Minnetonka Pavers  
Cobble Stone Pavers

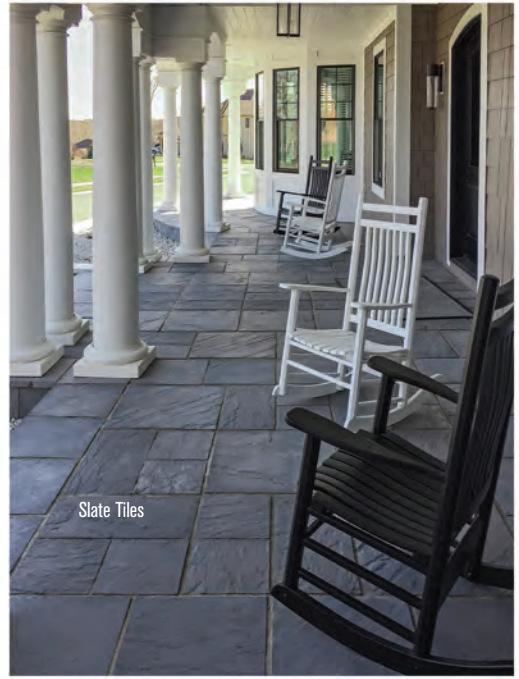

# USE THIS SIMPLE GUIDE TO HELP YOU AND YOUR LANDSCAPE PROFESSIONAL CREATE AN ATTRACTIVE AND COMFORTABLE LANDSCAPE YOU'LL ENJOY EVERY DAY.

The endless combinations of products available can make choosing your landscape and hardscaping materials very challenging. To simplify the task, follow these five design considerations when choosing materials for your backyard design.

## 1) STYLE

Style includes the shape, size and surface detail of a paver, slab, tile or wall. Choose a style that best suits the application, complements your surrounding architecture and expresses your personal flair.

## 2) COLOR

Whether you prefer a solid color, a blend or a combination of styles, shapes and colors, find one that complements your roofing, siding or stonework. Consider how furniture, decor and plantings in your plans work with the hardscapes colors you choose.

## 3) PATTERN

A qualified landscape professional will be able to help you understand what designs and patterns are available to you for your project and how those might impact the overall budget. If you find particular patterns or designs you like, share them with your contractor, this helps both of you zero-in on a design you both will be happy with.

## 4) DETAIL

Nothing completes a hardscape area like adding beautiful accents of inlays, caps/tops and borders. Use combinations of contrasting styles, color or patterns to create lasting flair for your outdoor living space.

## 5) ONCE YOU'RE READY TO BEGIN

Before planning your landscape project, check with your local zoning commission for building restrictions and required construction permits. Always call 811 before you dig.

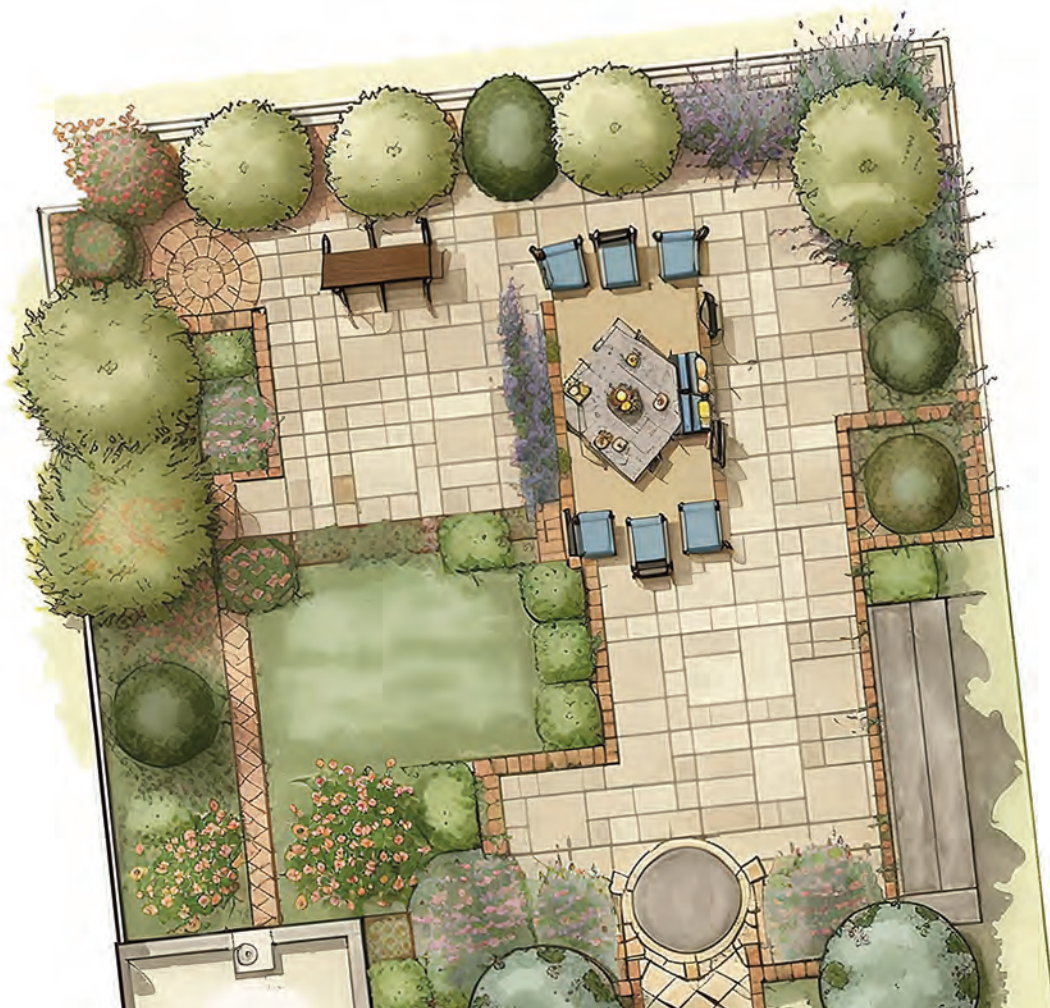

# FOLLOW THESE SIMPLE PLANNING STEPS:

## 1) DO YOUR HOMEWORK

Visit our website, Facebook or Instagram pages to see backyard patio plans, photos, ideas and MORE! The more ideas you have of hardscape materials, plants, accents and furniture, the better.

## 2) MAKE A WISH LIST

Make a list of things you like and dislike. If mowing the lawn or weeding a flower garden isn't for you, make note of it. Do you prefer rocks vs. mulch? Do you love flowers, but dread replanting every year? Highlight your interests below and share them with your landscape pro.

	Like	Dislike	Maybe
Modern	<input type="checkbox"/>	<input type="checkbox"/>	<input type="checkbox"/>
Natural	<input type="checkbox"/>	<input type="checkbox"/>	<input type="checkbox"/>
Relaxation / Quiet	<input type="checkbox"/>	<input type="checkbox"/>	<input type="checkbox"/>
Maintenance-free	<input type="checkbox"/>	<input type="checkbox"/>	<input type="checkbox"/>
Entertaining / Active	<input type="checkbox"/>	<input type="checkbox"/>	<input type="checkbox"/>
Matches Homes Architecture	<input type="checkbox"/>	<input type="checkbox"/>	<input type="checkbox"/>
Open and Spacious	<input type="checkbox"/>	<input type="checkbox"/>	<input type="checkbox"/>
Privacy and Shade	<input type="checkbox"/>	<input type="checkbox"/>	<input type="checkbox"/>
Eco-friendly / Energy Saving	<input type="checkbox"/>	<input type="checkbox"/>	<input type="checkbox"/>
Outdoor Kitchen	<input type="checkbox"/>	<input type="checkbox"/>	<input type="checkbox"/>
Outdoor Living Room	<input type="checkbox"/>	<input type="checkbox"/>	<input type="checkbox"/>
Accent Lighting	<input type="checkbox"/>	<input type="checkbox"/>	<input type="checkbox"/>
Fire Pit	<input type="checkbox"/>	<input type="checkbox"/>	<input type="checkbox"/>
Fireplace	<input type="checkbox"/>	<input type="checkbox"/>	<input type="checkbox"/>
Flower Garden	<input type="checkbox"/>	<input type="checkbox"/>	<input type="checkbox"/>
Water Feature / Pond	<input type="checkbox"/>	<input type="checkbox"/>	<input type="checkbox"/>
Paver Patio	<input type="checkbox"/>	<input type="checkbox"/>	<input type="checkbox"/>
Walkways	<input type="checkbox"/>	<input type="checkbox"/>	<input type="checkbox"/>
Sound System	<input type="checkbox"/>	<input type="checkbox"/>	<input type="checkbox"/>

## 3) MAKE A BUDGET

When budgeting, plan to invest about 7% to 10% of your home's value. A more elaborate backyard sanctuary may require 15% to 20%. Much of what you will spend depends on how long you plan to stay in your home. If you plan to stay for more than 10 years, 15% to 20% will give you the enjoyment you desire for years to come.

Home Value \$ \_\_\_\_\_ x \_\_\_\_\_ %

= \$

(Your landscaping budget)

## 4) SKETCH YOUR DESIGN

Take out a pencil and paper and start at the beginning. Sketching will help you discover your likes and dislikes and make your landscaping process much easier.

## 5) HIRE A PROFESSIONAL

If you're not quite the weekend warrior to tackle your own landscape construction, start talking to the professionals. Landscape pros are invaluable assets for their design expertise, product knowledge and construction methods.

When it's time to choose products, ask your landscaping professional for input.

There are countless pavers, slabs and landscape tiles to choose from, the same goes for retaining wall blocks. Knowing what products are best suited for a particular landscape application is crucial. For example, pavers designed for heavy vehicle traffic are not good choices for small patios or walkways. And with retaining walls, a heavy-duty wall system probably isn't the right product for use as a small garden wall.

There's no better way to select material than to see and touch the real thing.

Visit a Rochester Concrete Products distributor/dealer to touch and see actual samples in the colors you like. If you can't visit a dealer showroom where outdoor living products are displayed, ask your landscape contractor to gather samples for your consideration. Always refer to actual product samples when making color selection.

## THE REAL BENEFITS OF LANDSCAPING

Curb appeal – it's the best way to make a good first impression. Most homeowners agree, spending over \$45 billion on professional lawn and landscape services annually. Gardening has become America's #1 pastime, with over 80% of all households participating.

## WHAT DOES THIS MEAN TO YOU?

A well-designed landscape does more than bring increased value to your home, it brings energy savings as well. More importantly, quality landscaping brings you years of enjoyment. So follow the number one trend in the country and bring the indoors out by adding a raised patio, fire pit or an outdoor kitchen. Regardless of what you do, the enjoyment of the outdoors will reduce your stress and add real value to your home.



# NOT ALL PAVERS AND SLABS PERFORM THE SAME. KNOWING THE DIFFERENCES IS CRITICAL WHEN DECIDING WHICH TO USE.

Pavers need to compliment a property's architecture and style, maintain their beauty, perform as intended and last indefinitely. Use these product pages to discover which paver meets your project requirements

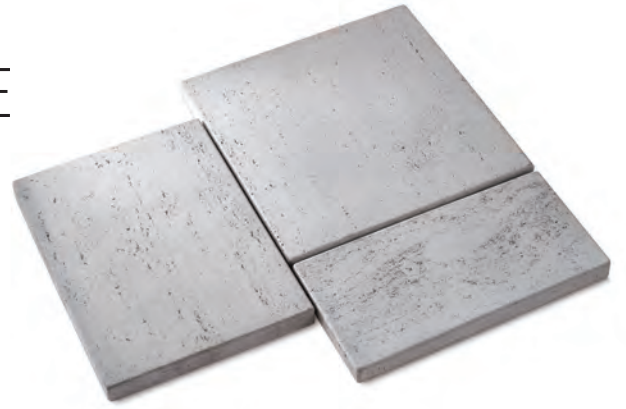

Antique Travertine - page 30

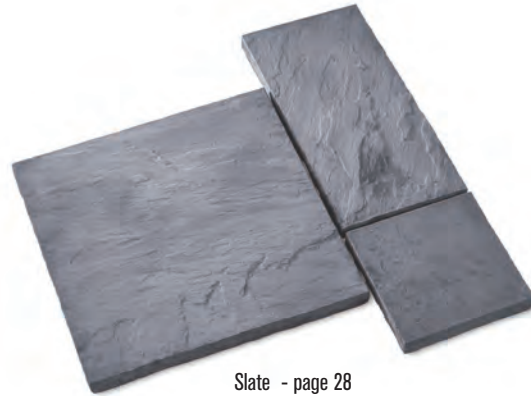

Slate - page 28



Barn Plank - page 26



Contours - page 32



Broadmour - page 46



Silhouette - page 34



Minnetonka - page 42



Barrington - page 38

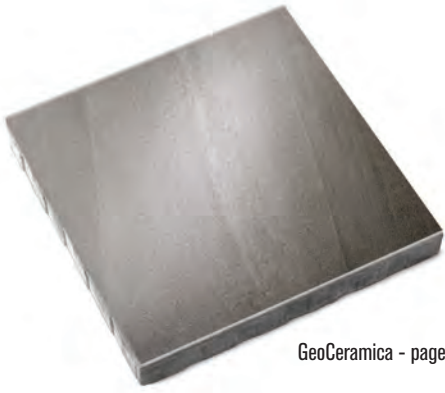

GeoCeramica - page 36



Serano - page 40



Mezzano - page 44



Reno - page 48



Tahoe - page 49



Lamont - page 56



Pacific-Eco - page 57



Cobble Stone - page 50



Titan XI (24 x 36" Slab)



Colonial - page 51



American Brick - page 52



Holland - page 55



# OUR PAVERS ARE DESIGNED TO ENABLE YOU TO CREATE THE EXACT LOOK AND FEEL YOU ARE TRYING TO ACHIEVE.

With a variety of shapes, unique colors, surface textures and dimensions at your disposal, our concrete pavers let you add a touch of personal flair to your living spaces. Whether you're a homeowner seeking a specific ambiance, a landscape designer aiming for a certain thematic flair, or a landscaper looking to impress clients, Rochester Concrete Products has an array of stylish and durable options to meet your needs.

All our pavers are meticulously crafted using our exclusive Amplified Interlock Manufacturing (AIM) process, a multi-faceted system that sets a new standard for consistency and quality. While other providers may increase prices for premium quality, we have extend our superior AIM standards to our entire range of pavers, backed by a lifetime guarantee.

## THE RCP PAVER COLLECTIONS...

**CHROMA SERIES:** Witness the charm of vibrant and consistent color with our Chroma series, thanks to our proprietary Chroma Coloring System. Implemented during the final production stages, the Chroma Coloring System imparts a saturated color layer on the surface of each unit, enhancing both aesthetic appeal and durability, making these pavers ideal for both residential and commercial use.

**CHROMA SHIELD SERIES:** Combining the Chroma Coloring System with our pre-treated Chroma Shield technology, the Chroma Shield series offers superior protection against sunlight, salt, and other corrosive elements, ensuring your pavers retain their fresh, vibrant color for a lifetime. The secret to Chroma Shield pavers lies in the first 3mm of the paver's surface, sealed with a chemical reaction, safeguarding the pavers unless subjected to significant abrasion.

**WHISPERS SERIES:** The Whispers Series features our latest additions to our product family, our Silhouette and Contours pavers. Silhouette pavers sport a gentle veining pattern that mimics the quiet elegance of nature, while the Contours pavers showcase a bold mottling effect that adds a unique color and character to the paver surfaces. When looking to make a quiet yet profound style statement, the Whispers Series has you covered.

**GEOCERAMICA:** Continuing our tradition of bringing innovative solutions to the U.S. paver market, we introduce GeoCeramica. Combining the resilience of porcelain with the easy installation of concrete pavers, GeoCeramica offers a low-maintenance, stain-resistant, and effortless-to-clean solution, ideal for outdoor kitchens and high traffic areas.

**SILVER CREEK COLLECTION:** Create a unique centerpiece in your outdoor space with our Silver Creek Collection. Whether it's the Antique Travertine pavers, modeled after the Italian originals, or Barn Plank pavers, inspired by a 17th-century Swiss barn, this collection offers the look and feel of natural stone at an affordable price.

**SPECIALTY PAVERS:** To cater to unique tastes and functional needs, we offer a range of specialty pavers. From the Lamont paver, designed to mimic European cobblestones, to our permeable pavers that aid water management, our specialty range is meant to cater to the unique requirements of your job.

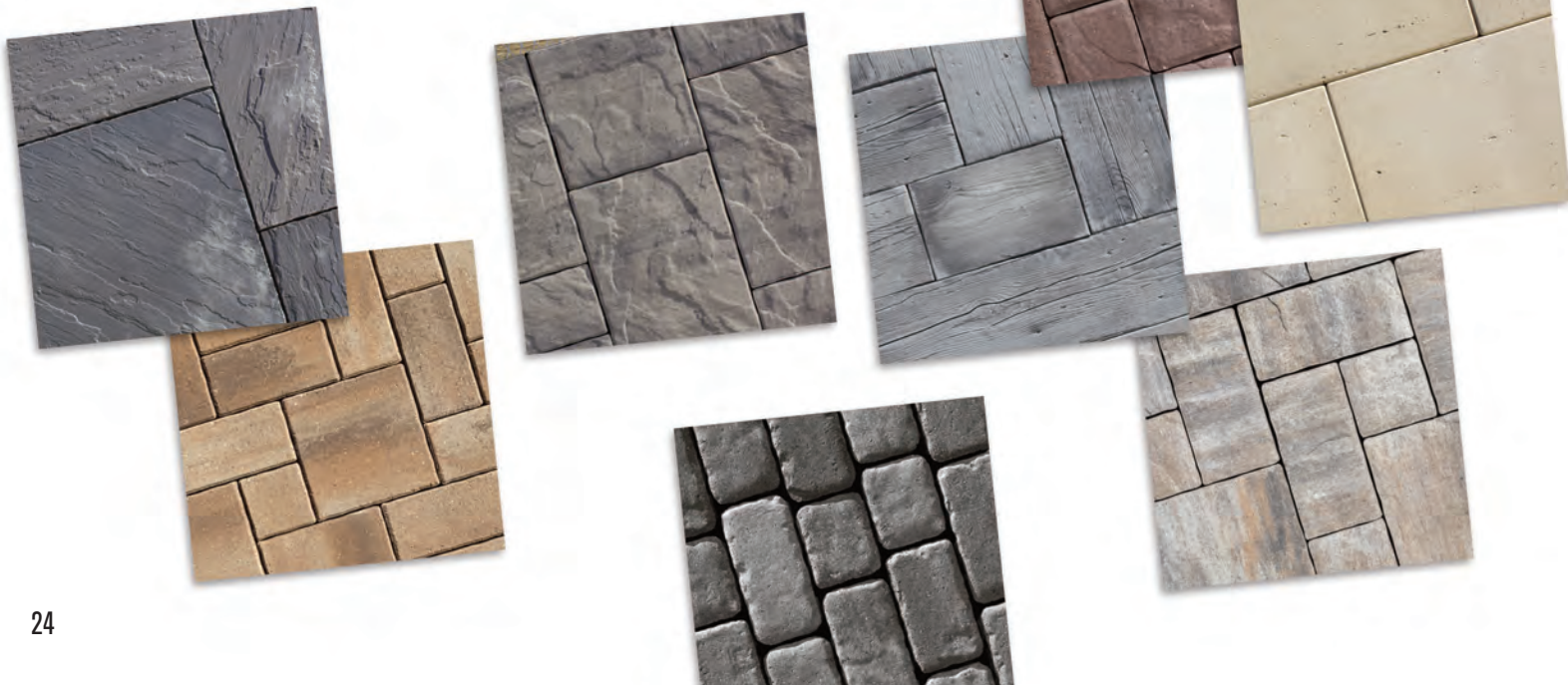



# CHROMA COLORING SYSTEM... A NEW STANDARD FOR VIBRANCY AND CONSISTENCY IN PAVER COLOR.

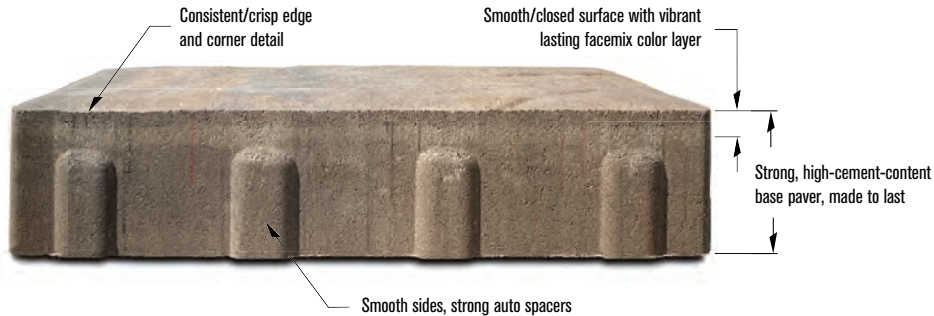

This advanced manufacturing technology provides rich and vibrant colors across all of our most popular products; Reno/Tahoe, Serano/Mezzano, Barrington/Minnetonka and our NEW Silhouette/Contours pavers. Chroma Coloring also ensures consistent colors from batch to batch – pavers ordered in August will have the same consistent and vibrant color as pavers ordered in May.

All pavers except Lamont, Holland-Eco and Pacific-Eco will now have Chroma Color (facemix) coloring.

## CHROMA SHIELD PROTECTED PAVERS STAND UP TO THE DAMAGING EFFECTS OF TIME AND MOTHER NATURE.



Chroma Shield manufactured pavers are highly resistant to fading and to the harmful effects of salt, chemical and acid rain exposure. Chroma Shield also provides some protection against stains and rust marks.

YEARS LATER, CHROMA SHIELD PAVERS REMAIN EXTREMELY FADE RESISTANT.

### WHAT IS CHROMA SHIELD?

The Chroma Shield manufacturing process is a series of chemical reactions between the paver and the Chroma Shield solution. As pavers are demolded, a proprietary aqueous-based solution is sprayed on the surface causing a chemical/molecular reaction that creates the Chroma Shield protective layer. This new protective compound penetrates into the surface of the paver three to five millimeters deep and can only be removed with heavy abrasion/wear.

### CHROMA SHIELD PAVERS ARE:

- Fade Resistant
- Acid Rain Resistant
- Spalling Resistant
- Stain Resistant
- Salt Resistant
- Inhibits Efflo and Poly Haze



# BARN PLANK



- For pedestrian paths, patios, pool decks and overlay applications
- Three sizes cast with multiple faces in two colors
- Strong wet cast concrete will never warp, splinter or rot
- Matching Step and Garden Wall blocks, and Fire Ring kit

**Separate Pallets:**

- 15.5" W x 9.75" D x 2" H
- 23.37" W x 9.75" D x 2" H
- 35" W x 9.75" D x 2"



MAHOGANY  
brown/black



WEATHERED GRAY  
gray/black

Barn Plank Landscape Tiles have the look of weathered white pine, with soft edges, deep splits and detailed grain on all sides.





# SLATE



- Suitable for pedestrian paths, patios, pool decks and overlay applications
- Four sizes, cast with multiple faces, in two colors
- Strong wet cast concrete, slate detailed top, chiseled sides
- Unique 24" x 36" XL size

**Separate Pallets:**

- 12" W x 12" D x 1-3/4" H
- 12" W x 24" D x 1-3/4" H
- 24" W x 24" D x 1-3/4" H
- 24" W x 36" D x 1-3/4" H (XL)



Slate's rich texture comes from masters made from stone quarried in the Northeastern U.S. where stone craftsmanship dates back to Colonial America.

# ANTIQUÉ TRAVERTINE



- Suitable for pedestrian paths, patios, pool decks and overlay applications
- Three sizes, cast with multiple faces, in two colors
- Strong wet cast concrete, honed surfaces with detailed marble texture

**Separate Pallets:**

- 12" W x 24" D x 2" H
- 18" W x 24" D x 2" H
- 24" W x 24" D x 2" H

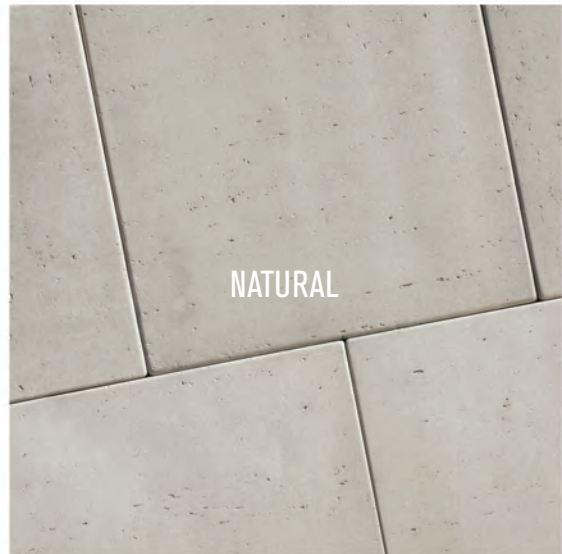

Cast in molds made from stone quarried in Tivoli, Italy, Travertine can be seen on famous landmarks like the Roman Colosseum, St. Peter's Basilica, the Getty Center and Lincoln Center.









# CONTOURS



CHROMA  
COLOR™



CHROMA  
SHIELD™



WHISPERS™  
TECHNOLOGY

- Suitable for patios, pathways and pool deck applications
- Angeled color veining and embossed surface mimics natural stone
- Three-piece, paver systems made in Chroma Color (facemix) with Chroma Shield protected surface
- Straight edge w/small auto spacer

**Contours Paver:** (sm. format, combined pallet, suitable for vehicular)

- 10" W x 5" D x 2-3/8" H
- 10" W x 10" D x 2-3/8" H
- 15" W x 10" D x 2-3/8" H

**Contours XL Slab:** (lg. format, combined pallet, not suitable for vehicular)

- 12" W x 18" D x 2-3/8" H
- 18" W x 18" D x 2-3/8" H
- 30" W x 18" D x 2-3/8" H



**BEIGE**  
textured paver or slab



**MIST**  
textured paver or slab



**FLINT**  
textured paver or slab

# SILHOUETTE



- Suitable for patios, pathways and pool deck
- Angled color veining and smooth surface mimics natural stone
- Three-piece, paver systems made in Chroma Color (facemix) with Chroma Shield protected surface
- Chamfered edge w/small auto spacer

**Silhouette Paver:** (sm. format, combined pallet, suitable for vehicular)

- 10" W x 5" D x 2-3/8" H
- 10" W x 10" D x 2-3/8" H
- 15" W x 10" D x 2-3/8" H

**Silhouette XL Slab:** (lg. format, combined pallet, not suitable for vehicular)

- 12" W x 18" D x 2-3/8" H
- 18" W x 18" D x 2-3/8" H
- 30" W x 18" D x 2-3/8" H







# GEOCERAMICA®

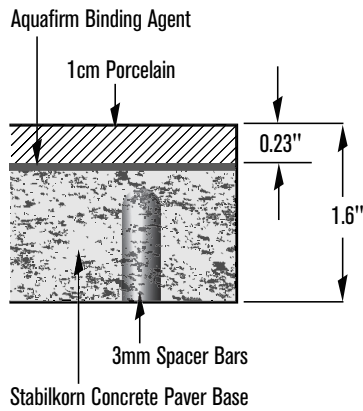

**GeoCeramica is the best of both worlds!**

GeoCeramica combines the low-maintenance and modern aesthetic of porcelain tile with the ease of installation of concrete pavers. GeoCeramica binds a 1cm porcelain tile to a concrete paver base using a proprietary Aquaferm binding agent.

- Suitable for patios, paths, pool decking and rooftop applications
- Slip-resistant porcelain top layer with multiple faces, integrated Stabilkorn® drainage paver base with small auto-spacers
- Resistant to chemicals, staining, fading, fire and scratching/heavy wear
- 24" W x 24" D x 1.6" H



# BARRINGTON



- Suitable for patios, pathways and pool decks
- Three-piece paver system made in Chroma Color (facemix) with Chroma Shield protected surface
- Smooth surface, chamfered/straight edge w/small auto spacer
- Combine/accent with American Brick, 6 x 12 Accent, Cobble Stone or Colonial pavers

**Combined Pallet:**

- 8" W x 16" D x 2-3/8" H
- 16" W x 16" D x 2-3/8" H
- 24" W x 16" D x 2-3/8" H



**BEECHWOOD**  
brown/charcoal/buff



**CASCADE**  
gray/black



**GLACIER CREEK**  
gray/brown/charcoal



**SANTA FE**  
gray/sandstone/brown









# SERANO



- Suitable for patios, pathways, pool decks and vehicular
- Three-piece paver system made in Chroma Color (facemix) with Chroma Shield protected surface
- Embossed surface, chamfered/irregular edge w/small auto spacer
- Combine/accent with American Brick, 6 x 12 Accent, Cobble Stone or Colonial pavers

**Combined pallet:**

- 6" W x 6" D x 2-3/8" H
- 6" W x 12" D x 2-3/8" H
- 12" W x 12" D x 2-3/8" H







# MINNETONKA



- Suitable for patios, pathways and pool decks
- Three-piece paver system made in Chroma Color (facemix) with Chroma Shield protected surface
- Embossed surface, chamfered/irregular edge w/small auto spacer
- Combine/accent with American Brick, 6 x 12 Accent, Cobble Stone or Colonial pavers

**Combined Pallet:**

- 8" W x 16" D x 2-3/8" H
- 16" W x 16" D x 2-3/8" H
- 24" W x 16" D x 2-3/8" H



# MEZANNO



- Suitable for patios, pathways, pool decks and vehicular
- Three-piece paver system made in Chroma Color (facemix) with Chroma Shield protected surface
- Embossed surface, chamfered/irregular edge w/small auto spacer
- Combine/accent with American Brick, 6 x 12 Accent, Cobble Stone or Colonial pavers

**Combined pallet:**

- 6" W x 6" D x 2-3/8" H
- 6" W x 12" D x 2-3/8" H
- 12" W x 12" D x 2-3/8" H





# BROADMOUR



- Suitable for patios, pathways and pool decks
- Small square and small rectangle suitable for vehicular
- Three sizes, made in Chroma Color (facemix) with Chroma Shield protected surface
- Smooth surface, chamfered/straight edge w/small auto spacer
- Combine/accent with American Brick, 6 x 12 Accent, Cobble Stone or Colonial pavers

**Separate Pallets:**

- 6" W x 12" D x 2-3/8" H
- 12" W x 24" D x 2-3/8" H
- 24" W x 24" D x 2-3/8" H





# RENO



- Suitable for patios, pathways, pool decks and vehicular
- Three sizes, made in Chroma Color (facemix)
- Smooth surface, chamfered/straight edge w/small auto spacer
- Combine/accent with American Brick, 6 x 12 Accent, Cobble Stone or Colonial pavers

**Combined Pallet:**

- 5" W x 10" D x 2-3/8" H
- 10" W x 10" D x 2-3/8" H
- 15" W x 10" D x 2-3/8" H







# TAHOE



Tahoe is the same paver system as Reno – but with an embossed surface. Both are popular for their high-end look at an entry level price.

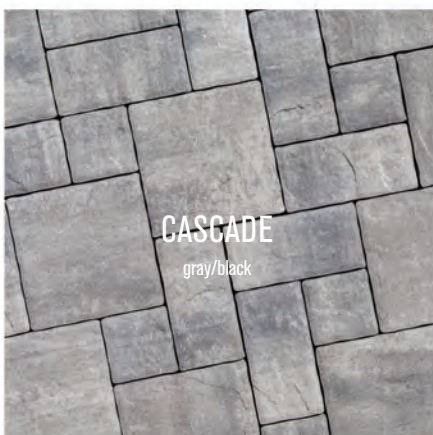

# COBBLE STONE



- Suitable for patios, pathways and vehicular
- Four-piece paver system, made in Chroma Color (facemix)
- Embossed surface, straight edge w/large auto spacer
- Eco-friendly, high-flow-rate permeable
- Combine/accent with American Brick, 6 x 12 Accent or Colonial pavers

#### Combined Pallet:

- 7" W x 6" D x 2-3/8" H
- 9" W x 6" D x 2-3/8" H
- 10" W x 6" D x 2-3/8" H
- 12" W x 6" D x 2-3/8" H

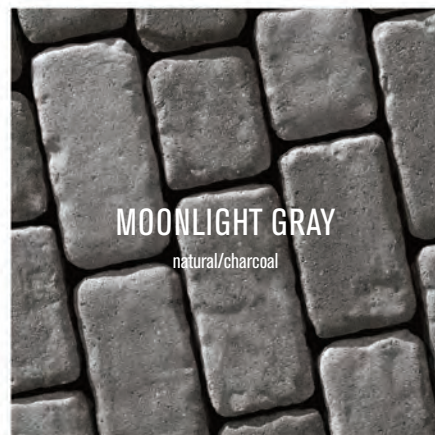

# COLONIAL



- Suitable for pedestrian and vehicular applications
- Four sizes, embossed surface, straight edge, small auto-spacer
- Chroma Color (facemix) based paver in two blended colors, 3/4 sq. and 6 x 8's available in three solid colors, Onyx is Chroma Shield protected
- Combine/accent with Colonial Rectangle or 3/4 sq., American Brick, Cobble Stone, 6 x 12 Accent or Lamont pavers

**Separate Pallets:**

- 6" W x 3" D x 2-3/8" H
- 6" W x 4" D x 2-3/8" H \* (3/4 sq.)
- 6" W x 6" D x 2-3/8" H
- 6" W x 9" D x 2-3/8" H\* (rectangle)

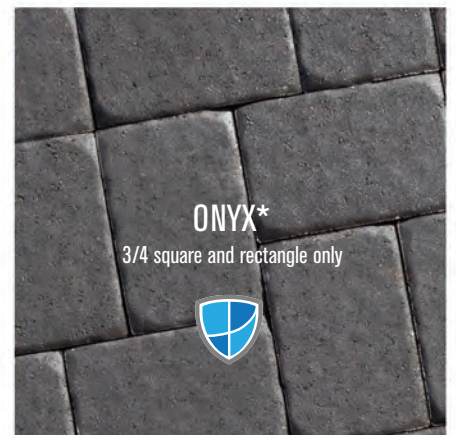

# AMERICAN BRICK



CHROMA  
COLOR™



CHROMA  
SHIELD™

- Ideal for insets, accents and borders
- One size, made in Chroma Color (facemix) with Chroma Shield protected surface
- Subtle embossed faces, chamfered/straight edge w/small auto spacer

**Combined Pallet:**

- 2.5" W x 8" D x 2-3/8" H



# 6 x12 ACCENTS



- Suitable for pedestrian and vehicular applications
- Embossed or smooth surfaces, straight edge w/small auto spacer, ideal for insets, accents and borders
- made in Chroma Color (facemix) with Chroma Shield protected surface
- Buff color available in four colors, embossed in three colors
- 6" W x 12" D x 2-3/8" H



# HOLLAND



- Suitable for pedestrian and vehicular applications
- Smooth surface, chamfered edge, no auto-spacer
- Made in Chroma Color (facemix)
- Combine/accent with American Brick, Cobble Stone, 6 x 12 Accent or Colonial pavers
- 9" W x 4" D x 2-3/8" H

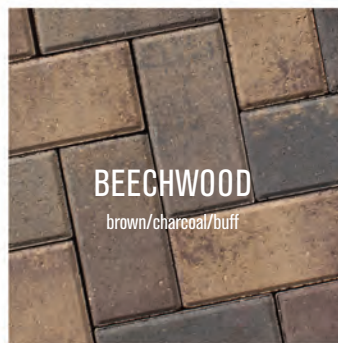

# HOLLAND-ECO



- Suitable for large pedestrian walkways and vehicular
- Eco-friendly, high-flow-rate permeable
- Smooth surface, straight edge w/large auto spacer
- Made with thru-mix (solid color)
- Palletized for machine install (herringbone pattern)

**Combined Pallet:**

- 5" W x 5" D x 3-1/8" H
- 10" W x 5" D x 3-1/8" H

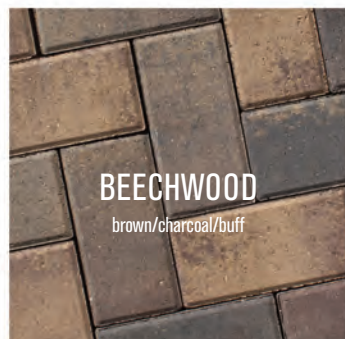

# LAMONT



TUMBLED

- Suitable for pedestrian and vehicular applications
- Four sizes, smooth/tumbled surfaces, no auto-spacer
- Thru-mix based pavers in three blended colors, 4 x 8 and 6 x 8's available in three solid colors\*
- Combine/accent with American Brick, Cobble Stone 6 x 12 Accent or Holland pavers

**Separate Pallets:**

- 4" W x 8" D x 2-3/8" H\*
- 6" W x 8" D x 2-3/8" H\*
- 10" W x 8" D x 2-3/8" H
- 12" W x 8" D x 2-3/8" H





# PACIFIC-ECO



- Suitable for large pedestrian walkways and vehicular
- Eco-friendly, high-flow-rate permeable
- Four-piece paver system, made with thru-mix (solid color)
- Smooth surface, chamfered edge w/large auto spacer
- Palletized for machine install
- Combine/accent with 8cm Holland-Eco

### Combined Pallet:

- 5" W x 5" D x 3-1/8" H
- 5" W x 10" D x 3-1/8" H
- 10" W x 10" D x 3-1/8" H
- 15" W x 10" D x 3-1/8" H



Permeable pavers allow rainwater to infiltrate the ground, reducing runoff, preventing flooding, and replenishing groundwater supplies.

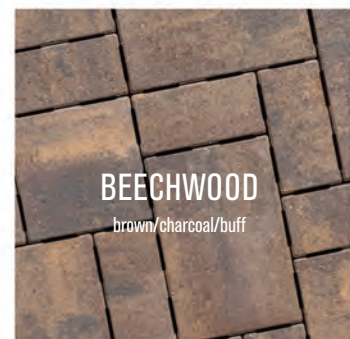
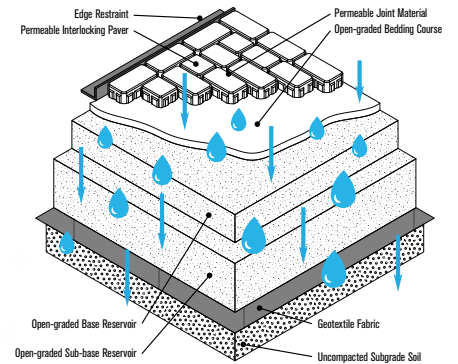



**MAHOGANY**  
brown/black

**WEATHERED GRAY**  
gray/black

# BARN PLANK WALL



- Strong, wet cast concrete, builds vertical, freestanding or retaining walls and outdoor living features
- Detailed splits and grain on five sides
- Weathered Gray or Mahogany colors, matching Landscape Tiles
- 40" W x 8" D x 6" H

#### **Barn Plank Wall Fire Pit Kit:**

- Two courses with heavy gauge steel insert to protect block
- Optional, removable swivel cooking grate
- 48" W x 48" D x 6" H



# OLYMPIC WALL



**ROCKWOOD**<sup>®</sup>  
RETAINING WALLS  
*A better way.™*



- Single-unit, trapezoidal design builds vertical freestanding/retaining walls, pillars and outdoor living features
- Smooth surfaces, deep beveled top and sides, in three colors
- Builds straight or 10' radius walls
- Finish with Contemporary or Chiseled Cap
- Matching 12" W x 10" D x 6" H corner, end/pillar block
- 17.5" W x 10" D x 6" H





**ROCKWOOD**  
RETAINING WALLS  
*A better way.*



**BEECHWOOD**  
brown/charcoal/buff



**CASCADE**  
gray/black



**ONYX**



# CONTEMPORARY WALL



- Three-piece wall system builds vertical, right-angle freestanding/garden walls, pillars and outdoor living features
- Smooth surfaces, beveled top and sides, in three colors, matching corner/pillar blocks
- Finish with Contemporary Cap, Chiseled Cap or Bullnose Paver

**Combined Pallet:**

- 8" W x 8" D x 4" H
- 16" W x 8" D x 4" H
- 24" W x 8" D x 4" H

**Corner/Pillar Block Pallet:**

- Use as wall block, corner or end block
- 12" W x 10" D x 4" H



# VINTAGE 6 WALL

- Three-piece system builds vertical, freestanding retaining walls, seatwalls and outdoor living features
- Choose from Split-face or Tumbled (matching End, Corner and Pillar blocks)
- Builds straight or 8' radius without cutting
- Cap with 4" Universal, 3" Tumbled or Chiseled cap

**Combined Pallet:**

- 6" W x 10" D x 6" H
- 12" W x 10" D x 6" H
- 18" W x 10" D x 6" H



SPLIT-FACE



TUMBLLED







# CLASSIC<sup>®</sup> 6 COLONIAL WALL

- Strong and versatile, efficient to build Classic system
- Rustic-face, deep beveled split/sides, multi-unit appearance
- Builds tight radius, 1.0" setback, adjustable to near vertical
- Cap with 3 or 4" Universal or Chiseled Caps

**One or Two Pallet System:**  
- 18" W x 12" D x 6" H

**ROCKWOOD<sup>®</sup>**  
RETAINING WALLS  
*A better way.<sup>™</sup>*





# CLASSIC<sup>®</sup> 6 & 8 WALLS



**BLUESTONE**

gray/brown/charcoal



**SANTA FE**

gray/sandstone/brown



**SANDSTONE BROWN**



- Strong and versatile, one-block systems build straight or radius walls
- Straight split or beveled face options (matching corner and half blocks)
- 1.0" setback, adjustable to near vertical
- Cap with 3 or 4" Universal or Chiseled Caps

**Classic 6 Block:**

- Beveled face colors: Bluestone, Sandstone/Brown, Santa Fe
- Straight face colors: Bluestone, Charcoal, Gray, Sandstone, Sandstone Brown, Santa Fe
- 18" W x 12" D x 6" H

**Classic 8 Block:**

- Beveled face colors: Gray, Sandstone
- Straight face colors: Gray, Sandstone, Sandstone Brown
- Straight face base block in Gray only
- 18" W x 12" D x 8" H

**ROCKWOOD**  
 RETAINING WALLS  
*A better way.™*



# PREMIER 6 & 8 WALLS

- Half the weight of comparable wall blocks, yet just as strong
- Significant freight advantages (more sq. ft. per truckload)
- Straight split face, matching Corner/End blocks
- Open core design; fill quickly & easily
- Automatic setback; adjustable to near vertical, capable of tight radius turns
- Cap with 3" or 4" Universal or Contemporary Caps



## Premier 6:

- 43.5 lbs.
- 4.7" (0.5" setback)
- In Bluestone, Santa Fe, Onyx colors  
(New color) Glacier Creek, Spring 2024
- 18" W x 12" D x 6" H

## (New) Premier 8:

- 57 lbs.
- 7" (1.0" setback)
- In Sandstone, Sandstone Brown, Charcoal, Grey
- 18" W x 12" D x 8" H



*The 4 x 2" anchor bar on the underside of Premier creates an automatic setback. When core-filled, Premier has with the highest resistance to shearing.*





**ROCKWOOD**  
RETAINING WALLS  
*A Better Way*



BLUESTONE



SANTA FE



SANDSTONE BROWN



ONYX



SANDSTONE



CHARCOAL



GRAY

# COTTAGE STONE WALL



**Cottage Stone:**

- For low garden walls, tree rings and planters
- Beveled-face, smooth top, in four colors
- Rear lip, 0.5" setback, curved bottom aids fast install
- Cap with Mini-Cap
- 12" W x 8.5" D x 4" H (25 lbs.)





# CONTEMPORARY CAP



CASCADE



BUFF



ONYX

- Finish retaining/seatwalls, pillars and outdoor living features
- One size, chamfered top, beveled sides, in three colors
- 24" W x 12" D x 2-3/8" H

**ROCKWOOD**<sup>®</sup>  
RETAINING WALLS  
*A better way.™*



# RECON WALL

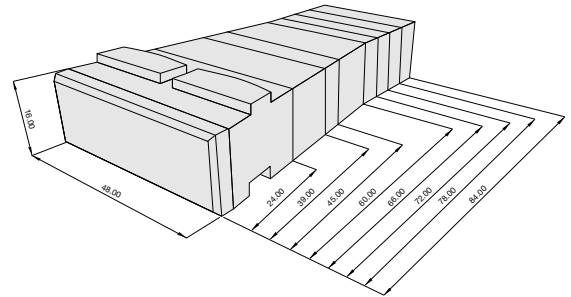

- Strong, solid, wet cast blocks for maximum performance
- Ideal for projects with tight property lines or limited access constraints.
- Matching corner, cap and half blocks (24" or 39" deep)
- Matching full fence or full high end/cap blocks
- Two styles available, stain applied after construction
- 48" W x 16" H, x (24" to 84" D) units, 1,457 to 4,088 lbs.



# KODAH & OUTCROPPING WALLS



## Kodah Wall:

- Strong, two-sided, wet cast blocks create vertical garden and freestanding walls
- Multiple sizes and faces with detailed tops in three colors
- Matching corner/end blocks
- Four-piece combined pallet; 12, 21, 30 & 42" W x 10.5" D x 6" H

## Outcropping Wall:

- Heavy, wet cast blocks build straight or 8.5' radius, 15° automatic setback
- Multiple shapes and faces, smooth top, matching corner/end blocks
- Lifting device required
- Multiple pallets; 6, 12, 18" & 24" H x 24" to 72" W



COPPER CANYON



FOND DU LAC



PACIFIC GRAY

# LAKELAND & RIVERLAND WALLS



TUMBLED

- Tumbled, three-piece wall systems build vertical, freestanding garden/retaining walls, planters, seatwalls and outdoor living features
- Matches tumbled Fire Ring Block
- Cap with 3" Universal or Chiseled Caps

#### Lakeland Wall:

- Three-sizes on two pallets, builds straight walls and 90° corners
- 4" W x 8" D x 4" H
- 8" W x 8" D x 4" H
- 12" W x 8" D x 4" H (separate pallet)

#### Riverland Wall:

- Three-piece, combined-pallet system, builds 8' radius walls
- 8" W x 8" D x 4" H
- 12" W x 8" D x 4" H
- 16" W x 8" D x 4" H



**ROCKWOOD**<sup>®</sup>  
RETAINING WALLS  
*A better way.™*





# WET CAST STEPS

**Chiseled Steps** are heavy, wet cast reproductions of handcrafted originals in two styles; chiseled riser/smooth top or, chiseled three sides/rough top.

- In Buff (not shown), Indiana Limestone, Bluestone colors
- 48" W x 18" D x 5.75" H



BLUESTONE



INDIANA LIMESTONE



**Barn Plank Steps** look just like reclaimed pine beams with detailed splits and grain on top and sides.

- In Mahogany or Weathered Gray colors
- 48" W x 18" D x 5.75" H



WEATHERED GRAY



MAHOGANY

# GRAND STEP

**Grand Steps** are reversible and can be installed with a smooth riser or split-face riser.

- Heavy, dry cast concrete in four colors
- Deep bevels on riser faces, smooth top and sides
- 48" W x 18" D x 6" H



**BUFF**



**BEECHWOOD**



**NATURAL**



**CHARCOAL**



Grand Steps are reversible and can be installed with either a split-face or smooth-face riser.



# STEPPING STONES

- Strong, wet cast reproductions of handcrafted originals
- Four unique shapes, 1.75" H (3.75 sq. ft. approx.)
- Split-face slate top, chiseled edge, sold in sets

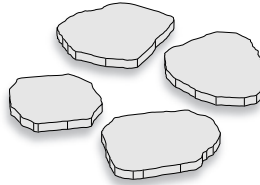

# BULLNOSE PAVER

- For treads, coping, seatwalls and accents
- Full radius front, smooth top/sides
- 6" W x 12" D x 2-3/8" H





# EDGING



**Classic Edger:**

- Wide base helps Classic Edge help minimize frost heave
- Smooth top/sides, beveled edge, in Sandstone, Charcoal, Gray, Brown, Red/Black colors
- 10" W x 2.75" D x 4" H

**Granite Edger:**

- Smooth sides, split-face top, tumbled
- Choose from Bluestone, Santa Fe or Onyx colors
- 12" W x 4" D x 4" H



**Interlock Bullet Edger:**

- Larger than typical edgers, separates mulch/rocks from turf
- Smooth top, beveled edge, interlocking design
- 12.25" W x 4" D x 4" H

# CHISELED CAPS

**Chiseled Caps and Tops** have the look of handcrafted limestone with hewn tops and chiseled sides. Use for pillars, seat/retaining walls, fire rings and outdoor living features. In Bluestone, Buff and Indiana Limestone colors.

**a) Fire Ring Cap:**

- Chiseled outside edge
- 8 pieces/set
- 10" D x 2.25" H

**d) Pillar Caps:**

- Chiseled four sides
- 25" W x 25" D x 2.25" H
- 30" W x 30" D x 2.25" H

**b) Straight Wall Caps:**

- Chiseled two or three sides
- 24" W x 12" D x 2.25" H

**e) Bar Tops:**

- Chiseled two sides, or chiseled three sides
- Indiana Limestone only
- 36" W x 48" D x 2.25"

**c) Radius Wall Caps:**

- Chiseled two sides
- 18.75" W x 12" D x 2.25" H

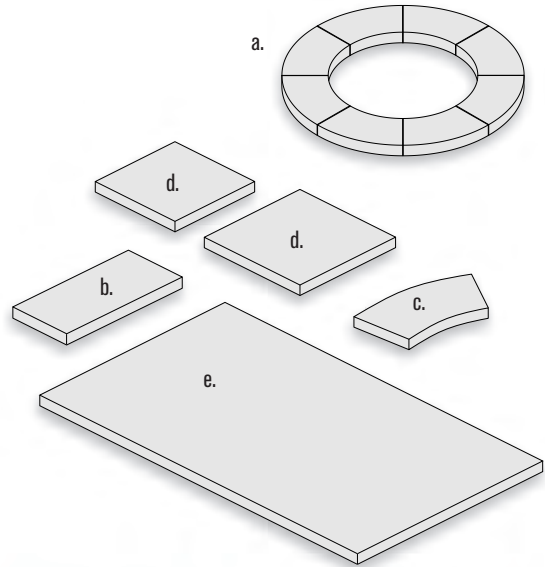



# CONTEMPORARY OUTDOOR LIVING KITS

Contemporary kits come with everything needed to build. Other than some common tools, kits come with everything needed to build on a properly prepared base. All stainless components, precut block, steel reinforcements, construction gloves, adhesive and step-by-step instructions.

- Easy-to-read, step-by-step instructions
- Rockwood's Contemporary Wall block
- Concrete precut and reinforcements sized to fit
- VOC-compliant adhesive and construction gloves
- In Cascade or Beechwood colors with Onyx accent course

## WOOD BURNING FIREPLACE:

- Fireplace; 52" W x 32" D x 86.5" H (base) w/protective firebrick
- Woodbox; 32" W x 32" D x 38.5" H (base)
- Hearth; 48" W x 16" D x 10.5" H (base)
- 2.5" H Silver Creek chisled mantels/tops



**ROCKWOOD®**  
RETAINING WALLS  
*A better way.™*

## ISLAND BAR/GRILL:

- Summerset Sizzler Pro 32" stainless grill with cover
- Stainless steel, vented double doors and paver vent kit
- Three-piece, 3cm black pearl granite top
- 32" D x 80" W x 40.75" H (base)

**GAS FIRE TABLE:**

Smokeless and ashless gas fire features are ideal for properties with open burning restrictions.

- Contemporary Wall Cap (in Cascade or Onyx)
- Firegear's stainless steel, NG drop-in pan and connections (100,000 max Btu)
- Piloted thermocouple safety valve, manual spark ignitor, lava rock and vent kit
- 68" W x 20" D x 18.5" H (base)

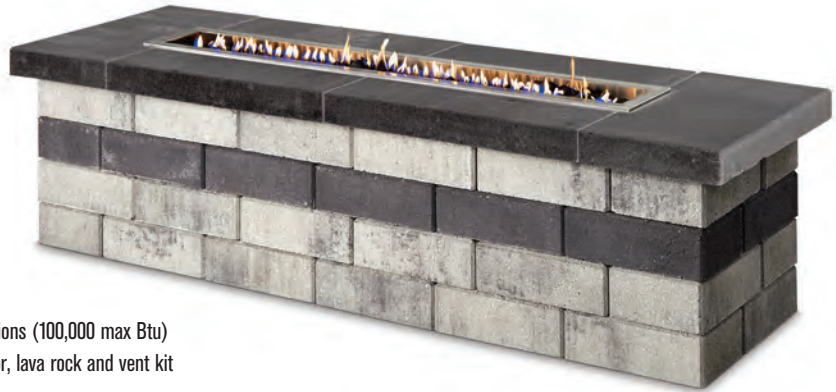

**GAS FIRE PIT:**

- Contemporary Wall Cap (in Cascade or Onyx)
- Firegear's stainless steel, NG drop-in pan and connections (150,000 max Btu)
- Piloted thermocouple safety valve, manual spark ignitor
- Lava rock and vent kit
- 48" W x 48" D x 18.5" H (base)



**WOOD BURNING FIRE PIT;**

- Heavy-gauge, four-piece steel insert
- Optional, removable swivel cooking grate
- Optional Contemporary Wall Cap (in Cascade or Onyx)
- 48" W x 48" D x 16" H



# NECESSARIES KITS



Necessaries mantels, caps and tops are cast from Indiana limestone originals and have smooth, honed surfaces with hand-chiseled edges.



BLUESTONE



CASCADE

**Necessaries is a collection of affordable, ready-to-assemble kits for outdoor fireplaces, island bars and grills, tables, waterfalls, fire rings, seatwalls and pillars.**

**Affordable luxury...**

Necessaries kits are both beautiful and functional, turning backyards into attractive and enjoyable outdoor living spaces. Also, Necessaries come ready-to-assemble with everything needed to build, making them easier to install and more affordable than typical masonry structures.

**Easy to build...**

Each Necessaries Outdoor Living Kit comes complete with everything you need, including pre-cut block sized to fit, reinforcements, adhesive, and easy-to-read, step-by-step instructions. Most kits can be built by two people during an afternoon, or less.

**Expand anytime...**

You can build your project all at once or add new features over time. Because of Necessaries' modularity, expanding your outdoor living space is easy to do whenever you are ready. Kits are not suitable for commercial installations or applications.



**Earthy cabinet colors:**

Necessaries feature Rockwood Retaining Walls' multi-piece, tumbled Lakeland and Riverland wall systems. Mantels and tops are wet cast concrete from limestone originals with smooth, honed surfaces and chiseled edges.

**Standard features:**

- Easy-to-read, step-by-step instructions
- Rockwood's Lakeland & Riverland blocks
- Reinforcements and concrete cut to fit
- VOC-compliant adhesive and gloves



BEECHWOOD



SANTA FE



ONYX  
fire ring kits only

**Compact** and **Colonial** Fireplace Kits are ideal for smaller backyards and patios. Each kit comes complete with 2.25" thick firebrick, ensuring durability and enhancing the overall appearance.

Fireplaces can be built with or without woodbox or hearth kits and all Necessaries kits can be customized.

See page 100 for dimensions.

---

Taller and wider, the **Victorian** Fireplace Kit becomes the focal point in any backyard. Popular for their affordability and smaller footprints, these fireplaces will generate warm accolades from family and guests for years to come.

- 2.25" firebrick for lasting protection
- Optional Woodbox Kit (left or right side)
- Optional Grand Hearth Kit



**COLONIAL FIREPLACE**



**VICTORIAN FIREPLACE**





## COMPACT FIREPLACE

The **Grand Fireplace Kit** is the perfect centerpiece for your outdoor living room. Its appeal comes from its large profile, universal design and aged appearance. Includes Majestic Products Villawood 36" stainless steel wood-burning insert, log rack and spark curtain.

- 4' stainless stovepipe chimney
- Spark suppressor cap
- Optional Woodbox Kit (left or right side)
- Optional Grand Hearth Kit



## GRAND FIREPLACE

# GRAND ISLAND KITS

For outdoor living enthusiasts who love cooking and entertaining, the Grand Island Bar/Grill Series is a wonderful addition to your home's backyard. Like all Necessaries Kits, the Grand Island bar series is modular and can be configured to fit your outdoor kitchen space.

Grand Island Bar Series tops are 2.25" H reproductions of Indiana Limestone originals.



Includes Summerset Pro Sizzler 32" NG or LP grill.  
Single door with grill shown, no longer available.



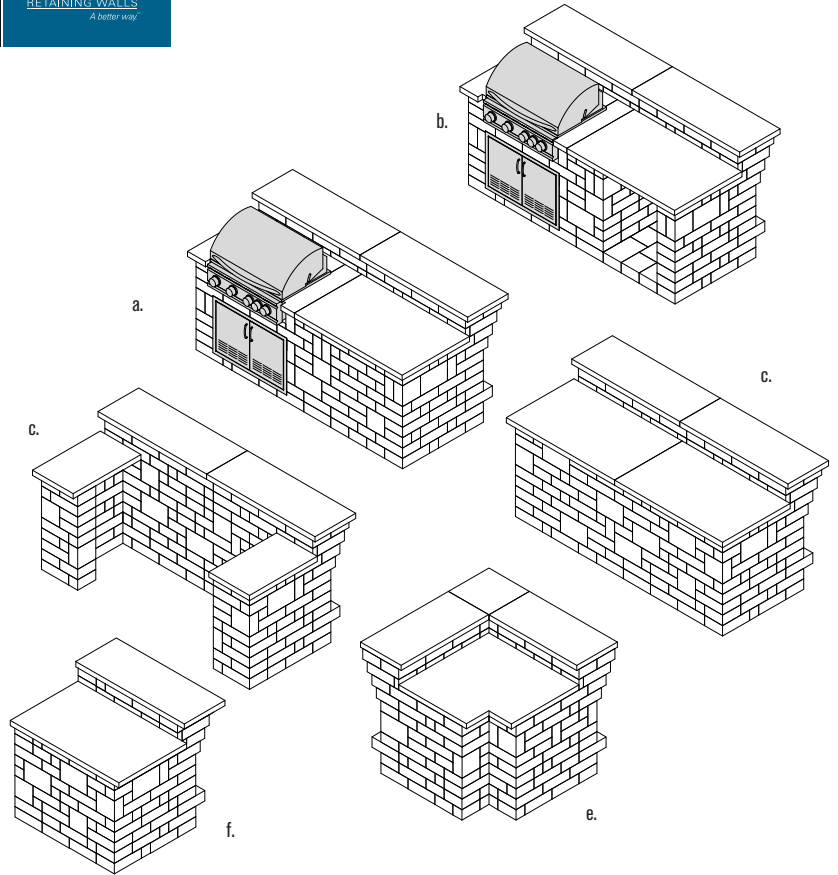

**a) Grand Island Bar/Grill w Storage Kit**

- Summerset Sizzler Pro 32" grill
- Stainless steel double doors

**b) Grand Island Bar/Grill w Refrigerator Opening Kit**

- Summerset Sizzler Pro 32" grill
- Stainless steel double doors

**c) Grand Island Bar 8' Kit**

**d) Grill Surround Kit**

- For standing grills, 60" opening

**e) Corner Return Kit**

- Makes L-shaped bar/grill

**f) Bar Section 4' Kit**

- Left or right facing

**Summerset Pro Sizzler Grills\***

- #443 stainless steel construction
- Push-to-turn knob ignition, 3" temp gauge
- 12,000 BTU #304 stainless steel burners
- 15,000 BTU infrared back burner
- Natural gas or propane fuel
- Double-lined hood assures optimal airflow
- 8mm cooking grates won't warp or rust
- Easy-clean briquette system for even heat
- 30" double stainless doors
- LED lights
- 14,000 BTU cast burners

- Heat zone separators

- Interior cooking lights

**Optional Deluxe Rotisserie:**

- #304 stainless steel
- Heavy-duty motor, 25 lb. capacity

\*120 volt electrical required.

[www.summersetgrills.com](http://www.summersetgrills.com)



SUMMERSET

OUTDOOR LIVING KITS



**Grand Fire Ring Kit:**

- 48" D x 12" H (31" interior dia.)
- One-piece, heavy gauge, solid steel insert protects block

**Optional:**

- **Fire Ring Block Layer:** add layers to increase height
- **Fire Ring Cap:** chiseled edge, eight-piece, in three colors, 2.25" H
- **Swivel Cooking Grate:** removable, heavy steel construction, ADA compliant
- **E-Z Access Spark Screen:** keep ash and sparks inside and debris out, hinged for easy access
- **Cover:** heavy galvanized steel with or without cooking grate slot



**GRAND FIRE RING**



**GRAND GAS FIRE RING**



Designed for slab, paver or gravel bases, the **Grand Gas Fire Ring Kit** has both style and convenience. Smokeless and ashless, it's an ideal alternative for properties with open burning restrictions.

- Push-button electronic ignition, 65,000 max BTU/hr
- NG or LP fuel type, thermo-couple auto shut-off feature
- #304 stainless steel construction
- 30 lbs. lava rock

**Optional:**

- **Grand Canyon Ceramic Log Set**
- **Fire Ring Block Layer** adds layers to increase height



**VICTORIAN FIRE PIT**

**Victorian Fire Pit Kit:**

- Four-piece, heavy gauge steel insert protects block
- Optional Swivel Cooking Grate



Pillars can be added to Seatwalls or built as a freestanding landscape feature, such as a property marker or light base.



**a) 20" Pillar Kit:**  
- 2.25" H chiseled cap

**c) 24" Pillar Kit:**  
- 2.25" H chiseled cap

**e) Riverland Seatwall Kit:**  
- Creates an 8' radius wall  
- Optional chiseled cap

**b) 20" Pillar with Glass Kit:**  
- Pittsburgh Corning Premiere 8" glass block  
- 2.25" H chiseled cap

**d) Lakeland Seatwall Kit:**  
- Creates a 6' straight wall  
- Optional chiseled cap

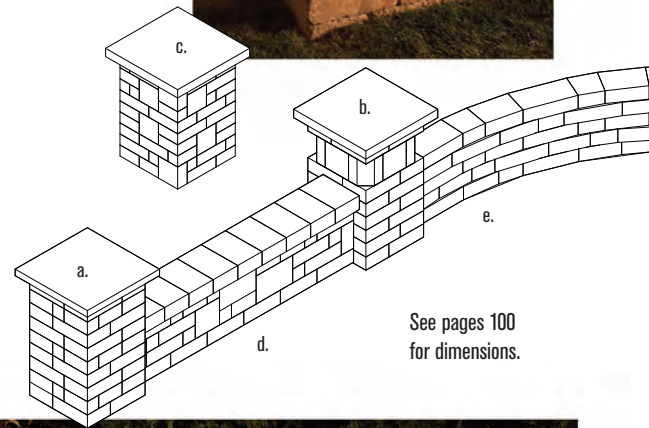

See pages 100 for dimensions.



Waterfall kits are easy to build and essentially maintenance-free. These above-ground designs are ideal when in-ground ponds and waterfalls are not an option. Waterfall kits include all plumbing/connections. 120 volt electrical required. Catch basin stones not included.

**Grand Waterfall Kit:**  
- 1,350 gph mag drive pump  
- 48" half-round basin  
- 23" stainless steel spillway  
- Optional LED light kit

**Compact Waterfall Kit:**  
- 850 gph mag drive pump  
- 26" square basin  
- 11" stainless steel spillway  
- Optional LED light kit

# KITCHEN KITS

Elegant, functional and affordable, Kitchen Kits are ready to assemble in any configuration you can imagine. Choose from two granite top colors and four block colors.

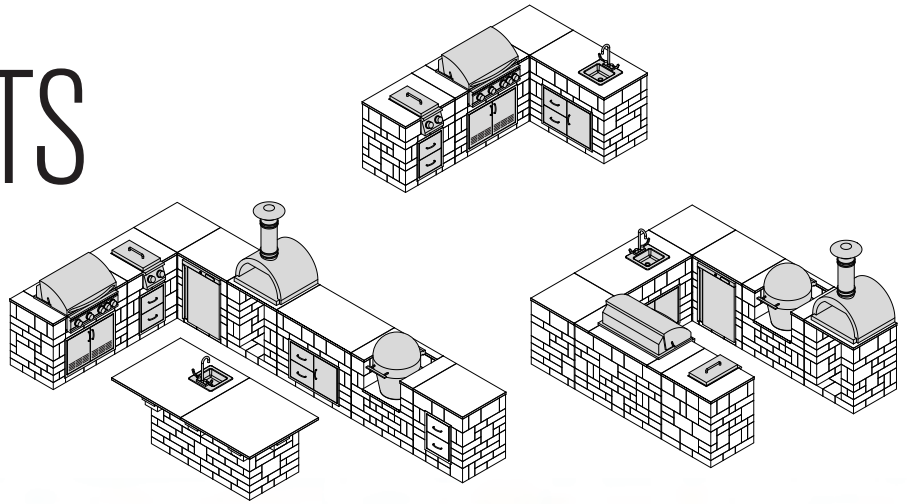

## Polished Granite Tops

Granite is an igneous rock formed billions of years ago when magma cooled deep beneath the earth's crust. Nearly as durable as diamond, granite owes its density and hardness to its origins – solidified under extreme pressure deep within the earth.

Granite is as durable as it is beautiful; it's not affected by extremes in temperature and under normal conditions, resists etching by knives, household acids and kitchenware.

Besides its beauty, granite is...

- 100% natural and non-toxic
- Cleans without difficulty
- Sanitary – when sealed, granite does not harbor bacteria
- Highly resistant to burning or charring from hot pans, appliances, utensils etc.



## Kitchen Kit Standard Features

- Easy-to-read, step-by-step instructions
- Solid granite tops in two color choices
- Reinforcements and concrete pre-cut and sized to fit
- Rockwood's multi-piece Lakeland block in four color choices
- VOC-compliant adhesive and gloves

## Earthy Cabinet Colors

Kitchen Cabinet kits feature Rockwood Retaining Walls' multi-piece, tumbled Lakeland wall block. Its linear design and aged appearance fit well in landscapes of any style or decor. Choose from four cabinet colors.



# GRILL CABINET



**32" Sizzler Pro Grill Cabinet\***  
- 48" W x 28" D x 37" H  
- 4 main burners, 56,000 max BTUs  
- 795 sq. in. cooking surface

**40" Sizzler Pro Grill Cabinet\***  
- 56" W x 28" D x 37" H  
- 5 main burners, 70,000 max BTUs  
- 985 sq. in. cooking surface

See pages 100 for dimensions.





## TRULY PREMIUM GRILLS...

Summerset's Pro Sizzler Grills are premium products at an unbeatable price. Designed with careful precision to ensure optimal airflow and even heating, these grills give their higher-priced competitors a run for their money in both durability and grilling performance. These grills will impress even the most discriminating grillmaster.

### Summerset Pro Sizzler Grill Features\*

- #443 stainless steel construction
- Push-to-turn knob ignition, 3" temp gauge
- 12,000 BTU #304 stainless steel burners
- 15,000 BTU infrared back burner
- Natural gas or propane fuel
- Double-lined hood assures optimal airflow
- 8mm cooking grates won't warp or rust
- Easy-clean briquette system for even heat
- LED lights
- 14,000 BTU cast burners
- Heat zone separators
- Interior cooking lights



### Optional Deluxe Rotisserie

- #304 stainless steel
- Heavy-duty motor, 25 lb. capacity
- \* Requires 120 volt electrical

## BACKED BY SERIOUS WARRANTIES!

**Grills:** Limited Lifetime warranty on construction and manufacturer defects. Limited Lifetime warranty on frame and housing. Limited Lifetime warranty on cooking grates, burners and valves. One year warranty on all other parts, components, and electrical.

**Concrete:** All Kits come with a limited lifetime warranty against material defect.

For complete warranties, visit us online at: [www.outdoorlivingkits.com](http://www.outdoorlivingkits.com)



**Refrigerator Cabinet Kit**

- 24" W x 24" D x 36" H opening
- Choice of granite and cabinet color
- Refrigerator not included or available

The **Island Cabinet Kit** is the centerpiece of your outdoor kitchen. Large enough to seat six adults, with over 28 sq. ft. of surface for prep, dining and entertaining.

- Two easy-glide stainless steel drawers and magnetic close door
- Choice of granite and cabinet color

**Drop in Sink (optional)**

- 15" L x 15" W x 6" D basin stainless sink
- Double handle valve stainless faucet
- Stopper/strainer

See pages 100 for dimensions.





**SIDE BURNER**

**Smoker Cabinet Kit**

- 24" W x 24" D opening for your smoker (smoker not available)

**Built-in Double Side-burner Cabinet Kit**

Combine the comfort of an indoor kitchen range with all the benefits of being outside. Specially designed for performance and function, Summerset's double side-burner is the perfect addition to your outdoor kitchen.

- #304 stainless steel construction
- Push-to-turn knob ignition
- Two easy-glide stainless steel drawers
- 30,000 Btu/hr solid brass burners
- 19.5" x 10.5" cooking surface

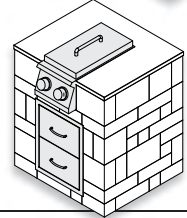
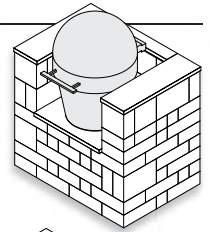

**Trash Drawer Cabinet Kit**

- #304 stainless steel construction
- Easy-glide pullout drawer, hold a 12-gallon trash can

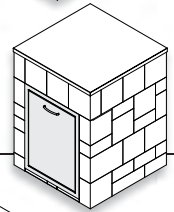

**Storage Cabinet Kit**

- Easy-glide stainless steel drawers
- Fully enclosed stainless steel outside

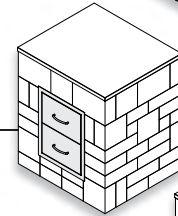

**Corner Cabinet Kit (not shown)**

- For L-shaped designs or additional length

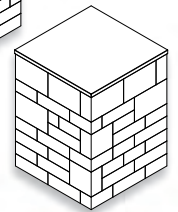

**PREP CENTER**

**Prep Center Cabinet Kit**

With over 9 sq. ft. of surface, the Prep Center Cabinet will be appreciated for its generous workspace. Build it with the optional sink, and it will make your outdoor kitchen truly complete.

- Two easy-glide stainless steel drawers and magnetic close door
- Choice of granite/cabinet colors
- Optional drop-in sink

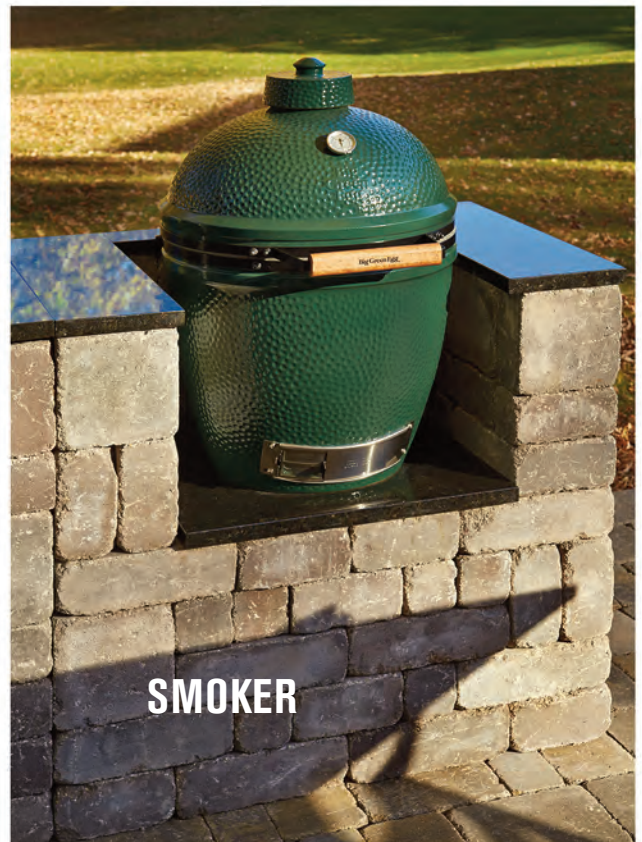

**SMOKER**

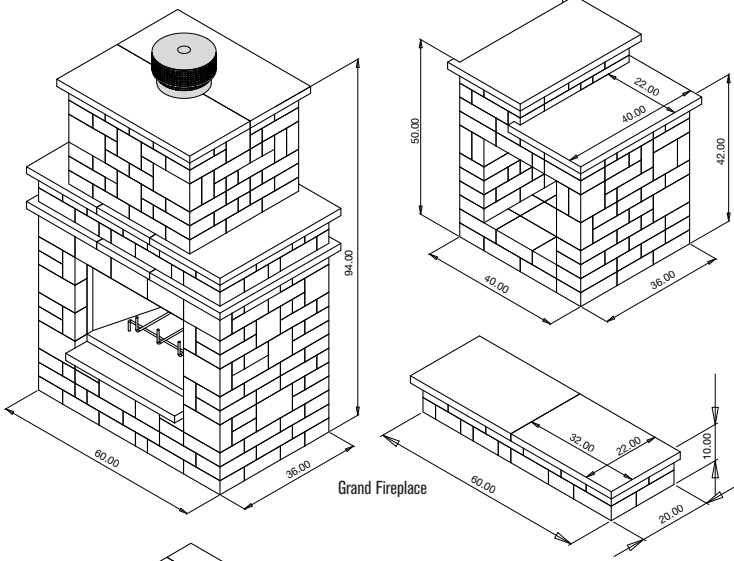

Grand Fireplace

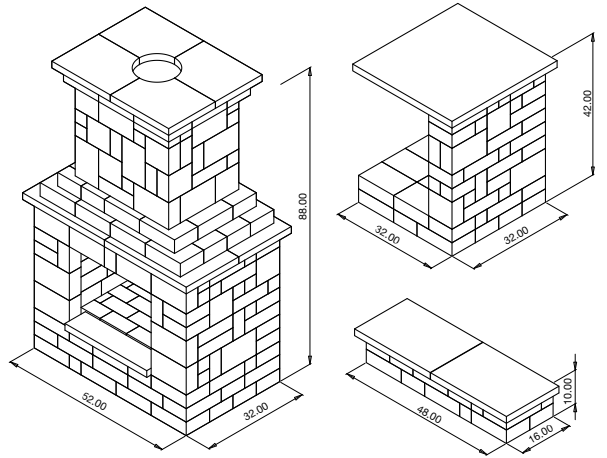

Victorian Fireplace

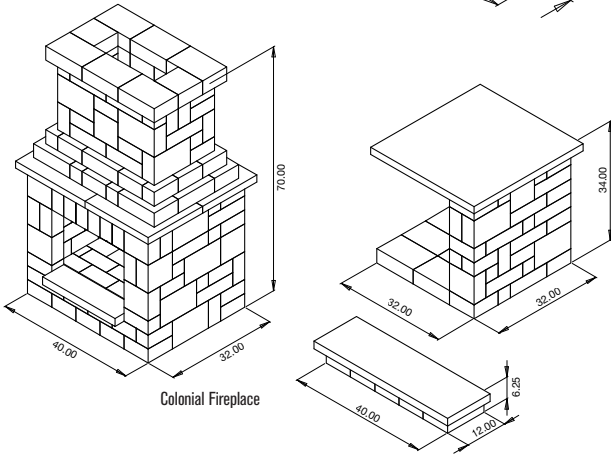

Colonial Fireplace

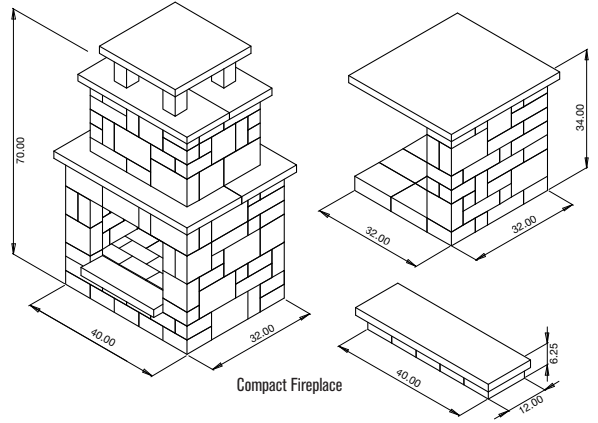

Compact Fireplace

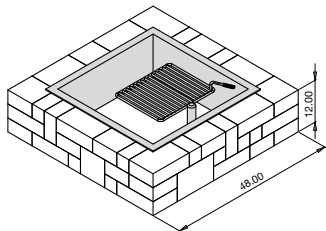

Victorian Fire Pit

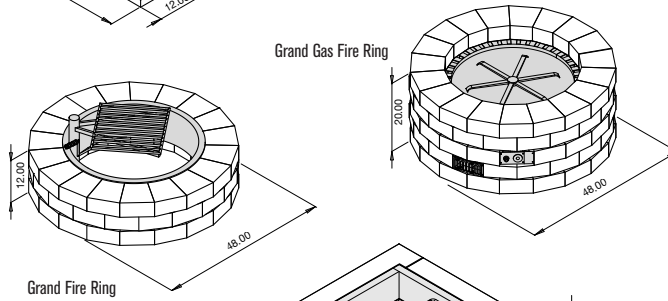

Grand Gas Fire Ring

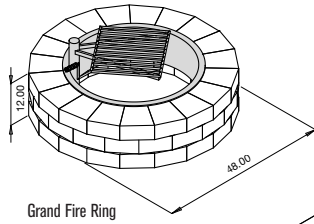

Grand Fire Ring

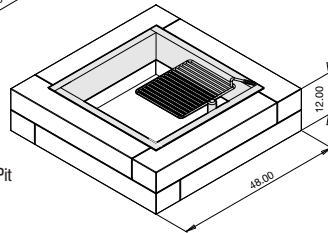

Barn Plank Wall Fire Pit

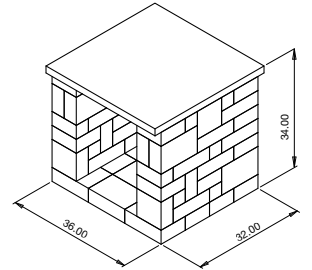

Woodbox/Stand

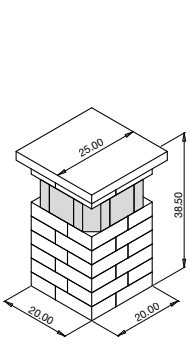

20" Pillar w/ Glass

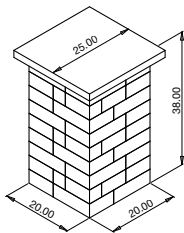

20" Pillar

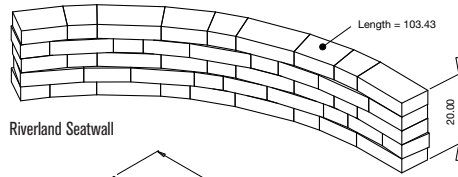

Riverland Seatwall

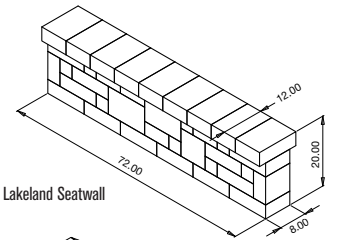

Lakeland Seatwall

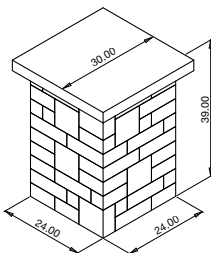

24" Pillar

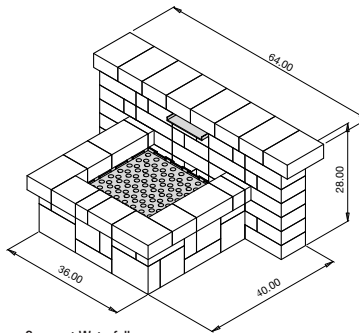

Compact Waterfall

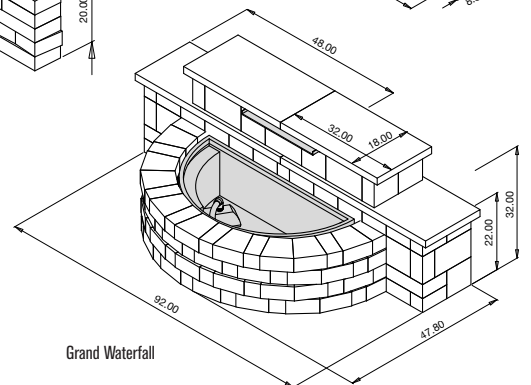

Grand Waterfall

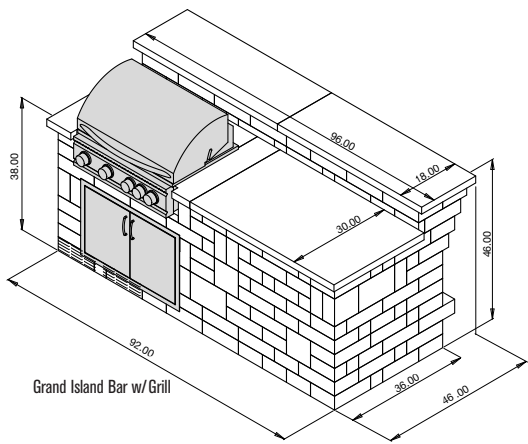

Grand Island Bar w/Grill

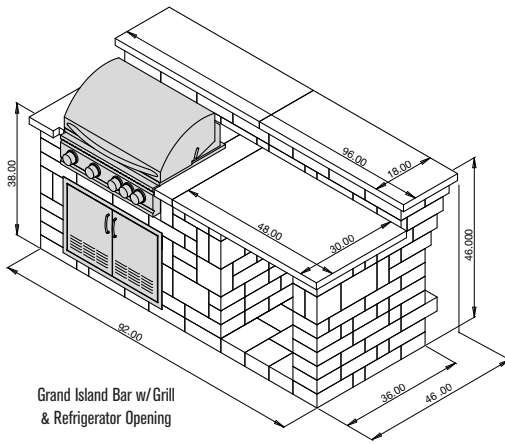

Grand Island Bar w/Grill & Refrigerator Opening

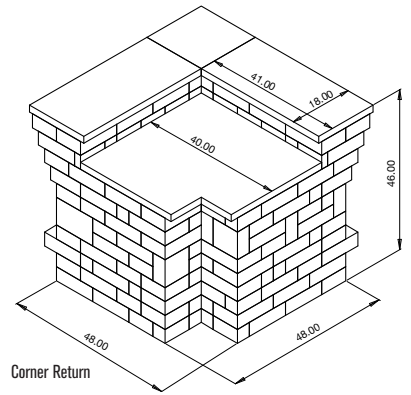

Corner Return

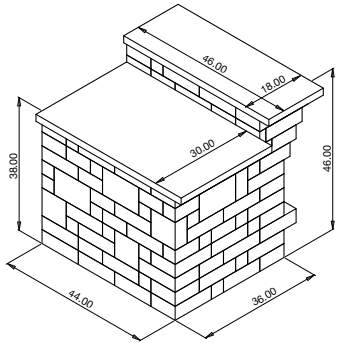

4' Bar Extension

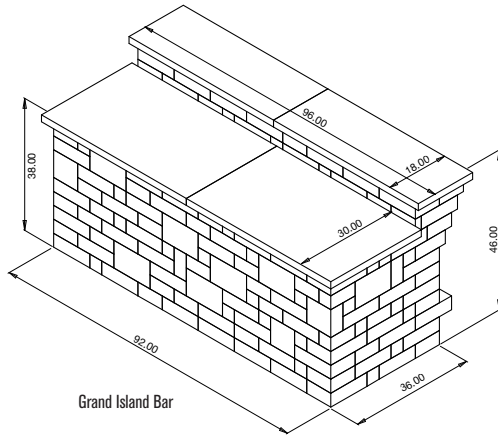

Grand Island Bar

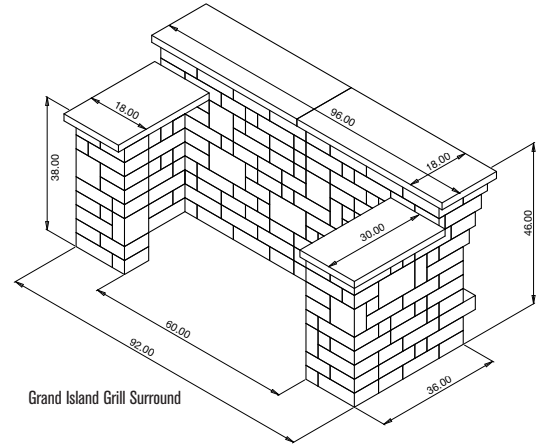

Grand Island Grill Surround

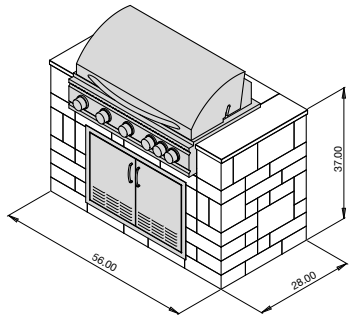

40" Sizzler Grill Cabinet

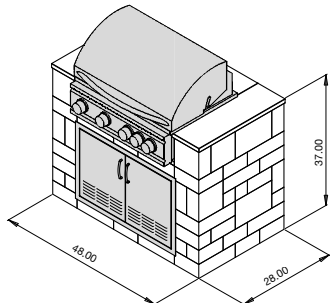

32" Sizzler Grill Cabinet

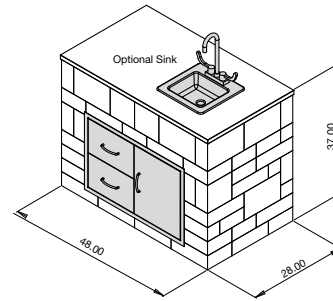

Prep Station Cabinet

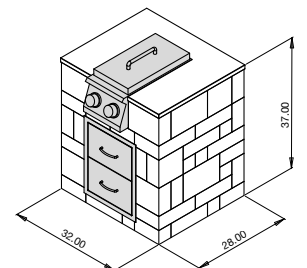

Side Burner Cabinet

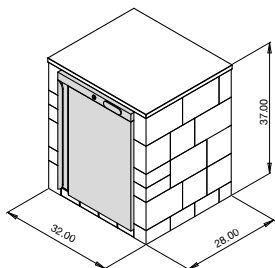

Refrigerator Cabinet

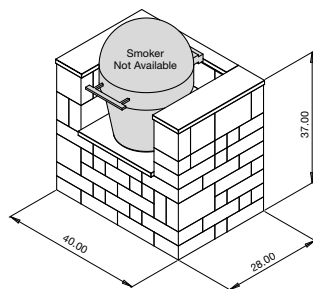

Smoker Cabinet

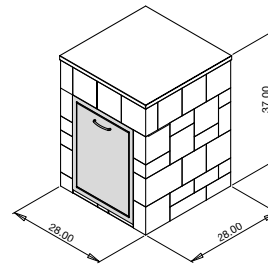

Trash Cabinet

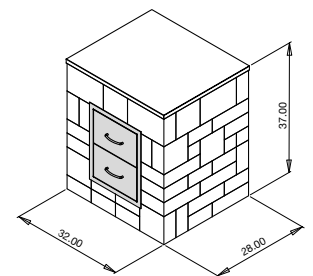

Two Drawer Cabinet

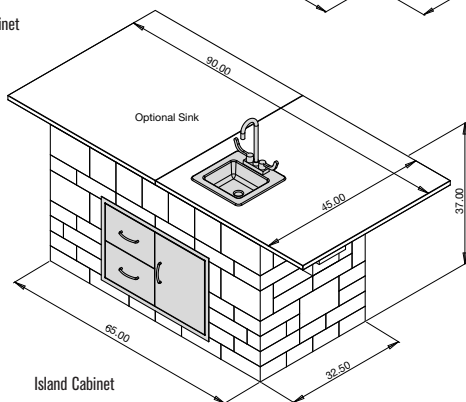

Island Cabinet

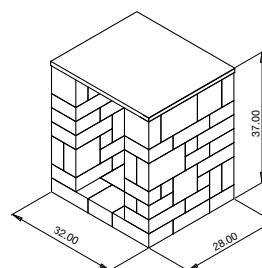

Woodbox/Stand Cabinet

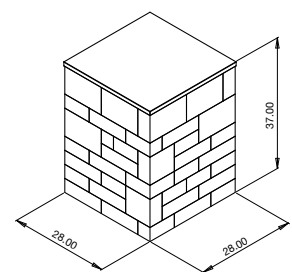

Corner Cabinet

OUR PRODUCTS ARE DESIGNED TO WITHSTAND THE EVERYDAY USE AND ABUSE THAT YOU, TIME AND MOTHER NATURE CAN THROW AT THEM. OUR LIMITED LIFETIME WARRANTY ASSURES HOMEOWNERS THAT WHAT'S MEANT TO LAST, WILL LAST. AND IF IT DOESN'T, WE'LL STAND BEHIND IT.



**LIMITED LIFETIME WARRANTY**

**IMPORTANT NOTICE:** Read this entire RCP Limited Lifetime Warranty and Limitation of Liability (“Limited Warranty”). It is important that the warranted products be properly installed and maintained in order for them to function successfully throughout the duration of this Limited Warranty. Depending on the product’s application, installation guides can be found at [www.rochesterpcp.com](http://www.rochesterpcp.com). It is also important for your installer to carefully review the technical information, including specifications, for the chosen use of your RCP products as it may be the responsibility of the installer or design engineer to provide independent soil testing, quality assurance inspection, testing, and design services necessary to ensure a safe and functional application.

This Limited Warranty applies only to RCP products that are purchased and used as part of Rockwood Retaining Wall Systems installed in owner-occupied single-family homes within the United States, subject to the stated conditions and limitations. This Limited Warranty does not extend to any current or future products distributed, but not manufactured, by RCP. This Limited Warranty applies only to RCP’s products and not to the system into which they may be placed. Nor does this Limited Warranty cover RCP products used in governmental, commercial, or multi-residential applications.

**LIMITED LIFETIME WARRANTY FOR RCP PRODUCTS INSTALLED IN OWNER-OCCUPIED SINGLE-FAMILY HOMES AS A PART OF A ROCKWOOD WALL OR HARDSCAPE SYSTEM.**

RCP warrants that its products will be free from defects for as long as you own your home. If RCP is given prompt notice of a defect, it shall, at its sole option: (1) repair or replace the defective product(s), or (2) refund the original purchase price of the defective product(s). This Limited Lifetime Warranty is provided only to the owner(s) of the home at the time of purchase and may not be assigned or transferred. In the event the owner(s) sells the home, this warranty automatically converts to a two-year limited warranty affording the same scope of protection and governed by the same conditions, disclaimers and limitations of this Limited Lifetime Warranty. If RCP elects to repair the defect, it shall be responsible for the labor to accomplish the repair. If RCP elects to replace the defective product(s), its obligation is to deliver suitable replacement product to owner’s property.

**LIMITATION OF LIABILITY**

This Limited Warranty sets forth the maximum liability for our products. IN NO EVENT (INCLUDING WHERE THIS LIMITED WARRANTY IS DEEMED NOT TO APPLY TO THE SALE OR PRODUCT IN QUESTION) SHALL RCP, GLS INDUSTRIES, INC., OR ROCKWOOD RETAINING WALLS, INC. BE LIABLE FOR ANY INCIDENTAL, CONSEQUENTIAL OR SPECIAL DAMAGES RESULTING FROM THE SALE, INSTALLATION OR USE OF ANY RCP PRODUCTS. Some states do not allow the exclusion or limitation of incidental or consequential damages for consumers, so the above limitation or exclusion may not apply to you.

**LIMITATION OF WARRANTY**

RCP MAKES NO OTHER WARRANTIES, EXPRESS OR IMPLIED, INCLUDING ANY IMPLIED WARRANTIES FOR MERCHANTABILITY, FITNESS FOR A PARTICULAR PURPOSE OR OTHERWISE.

**DISCLAIMER – WHAT THIS LIMITED WARRANTY DOES NOT COVER**

RCP is not responsible for or makes no warranty as to:

1. Product failure, loss or damage due to:
  - Normal wear and tear;
  - Damage due to improper handling and repeated or extended contact with chemicals, such as de-icers;
  - Products improperly installed or maintained;
  - Acts of God;
  - Structural settlement, movement or vibration;
  - Products that have not been paid for in full.
2. Minor imperfections
  - Minor imperfections that do not affect the product’s structural integrity;
  - Variations in product texture or color;
  - Efflorescence;
  - Minor imperfections in shape, appearance, or dimensions covered by ASTM C1372.

**CONDITIONS OF WARRANTY – WHAT YOU MUST DO TO RECOVER UNDER THIS LIMITED WARRANTY**

**PROMPT NOTICE OF DEFECT:**

Within the warranty period, you must promptly, and in no case more than one (1) year after any defect or other basis of a claim covered by this Limited Warranty is discovered or should have been discovered, notify RCP of the defect. Any claims otherwise covered by this Limited Warranty, but for which RCP did not receive notice of the defect within one (1) year from the time the problem first became known, shall be barred.

**LIMITED WARRANTY CLAIM PROCEDURE**

Claims under this Limited Warranty may be made in writing to RCP at 7200 Broadway Ave. N, Rochester, MN 55906.

Claims should include the following information:

1. Claimant’s name, address and phone number, and the installation address (if different);
2. A description of the product, purchase price, date and location of purchase, and copies of invoices, if available;
3. A description of the defect(s) (photos are required); and
4. A brief summary of attempts made to address the concerns.

**NO STATEMENT OF USEFUL LIFE**

This Limited Warranty is not a statement of the useful life of any RCP products.

dms.us.51883281.01



Rochester Concrete Products is third generation family owned business with mortarless concrete manufacturing experience dating back to 1914.

© 2024 Rochester Concrete Products. All Rights Reserved. All trademarks and registered trademarks are the property of their respective owners. Rockwood Retaining Walls products are made worldwide under license from Rockwood Retaining Walls, Inc. US and international patents issued and pending. 324

Printed in the USA.



THE NEW STANDARD



# GEOCERAMICA<sup>®</sup>

LIFE'S TOO SHORT FOR BORING PAVERS!



Corporate Office: 7200 Broadway Ave. N., Rochester, MN 55906 • Phone (507) 288-8850 • [rochesterpcp.com](http://rochesterpcp.com)

